

# TADEUSZ 5

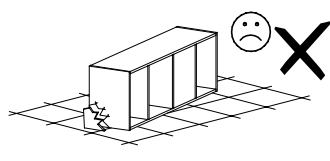

Narzędzia potrzebne do montażu

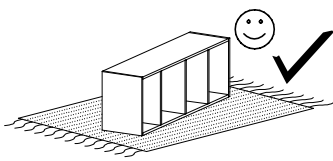
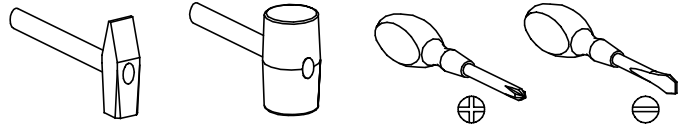

## UWAGA !!!

MONTOWANIE USZKODZONYCH  
ELEMENTÓW POWODUJE UTRATĘ  
GWARANCJI

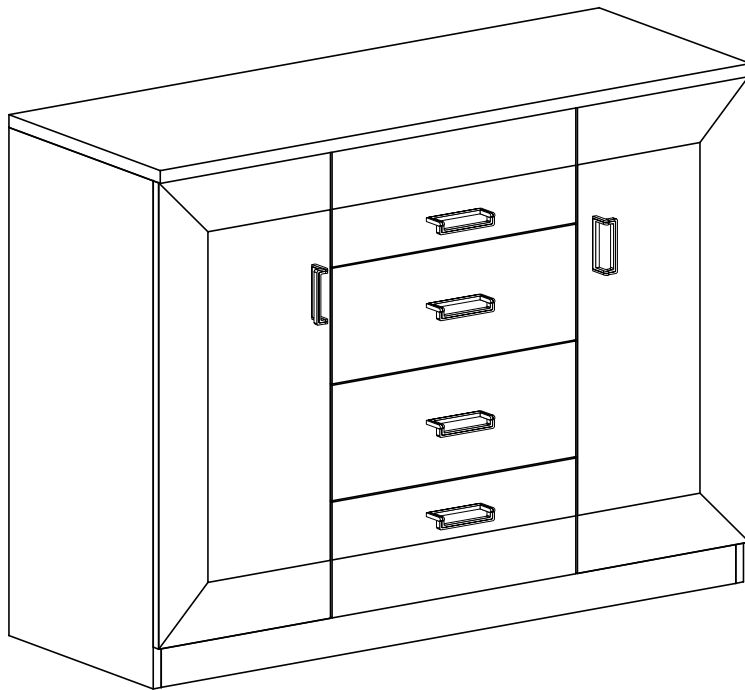

| Nr | D[mm] | S[mm] | G[mm] | Ilość |
|----|-------|-------|-------|-------|
| 1  | 1200  | 440   | 32    | 1     |
| 2  | 1154  | 405   | 16    | 1     |
| 3  | 770   | 405   | 16    | 1     |
| 4  | 770   | 405   | 16    | 1     |
| 5  | 865   | 405   | 16    | 1     |
| 6  | 1154  | 80    | 16    | 1     |
| 7  | 1178  | 810   | 2,5   | 1     |
| 8  | 360   | 150   | 16    | 4     |
| 9  | 400   | 150   | 16    | 4     |
| 10 | 400   | 150   | 16    | 4     |
| 11 | 437   | 190   | 16    | 4     |
| 12 | 405   | 388   | 2,5   | 4     |
| 13 | 380   | 350   | 16    | 2     |
| 14 | 777   | 370   | 16    | 1     |
| 15 | 865   | 405   | 16    | 1     |
| 16 | 777   | 370   | 16    | 1     |

W przypadku reklamacji proszę podać numer pakowacza znajdujący się na kartonie.

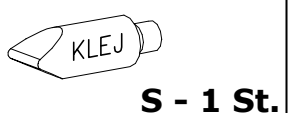
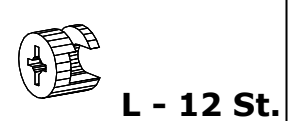
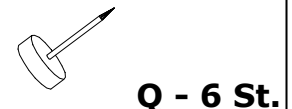
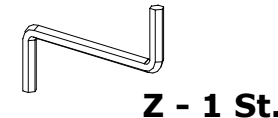
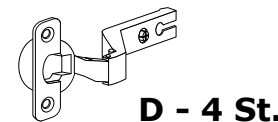
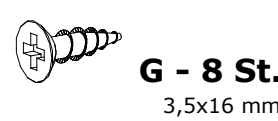
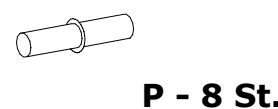
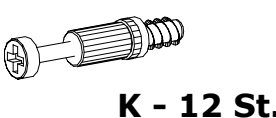
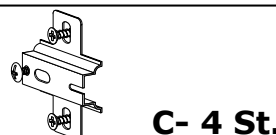
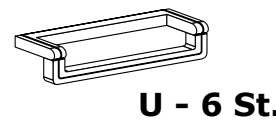
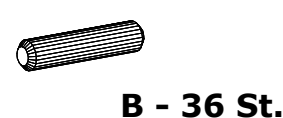
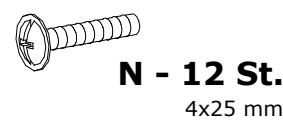
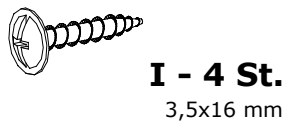
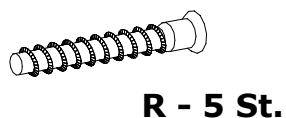
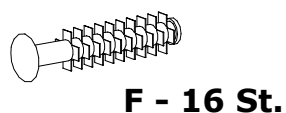
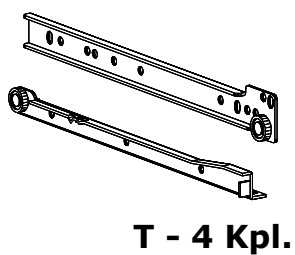
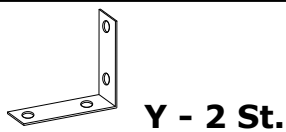

I

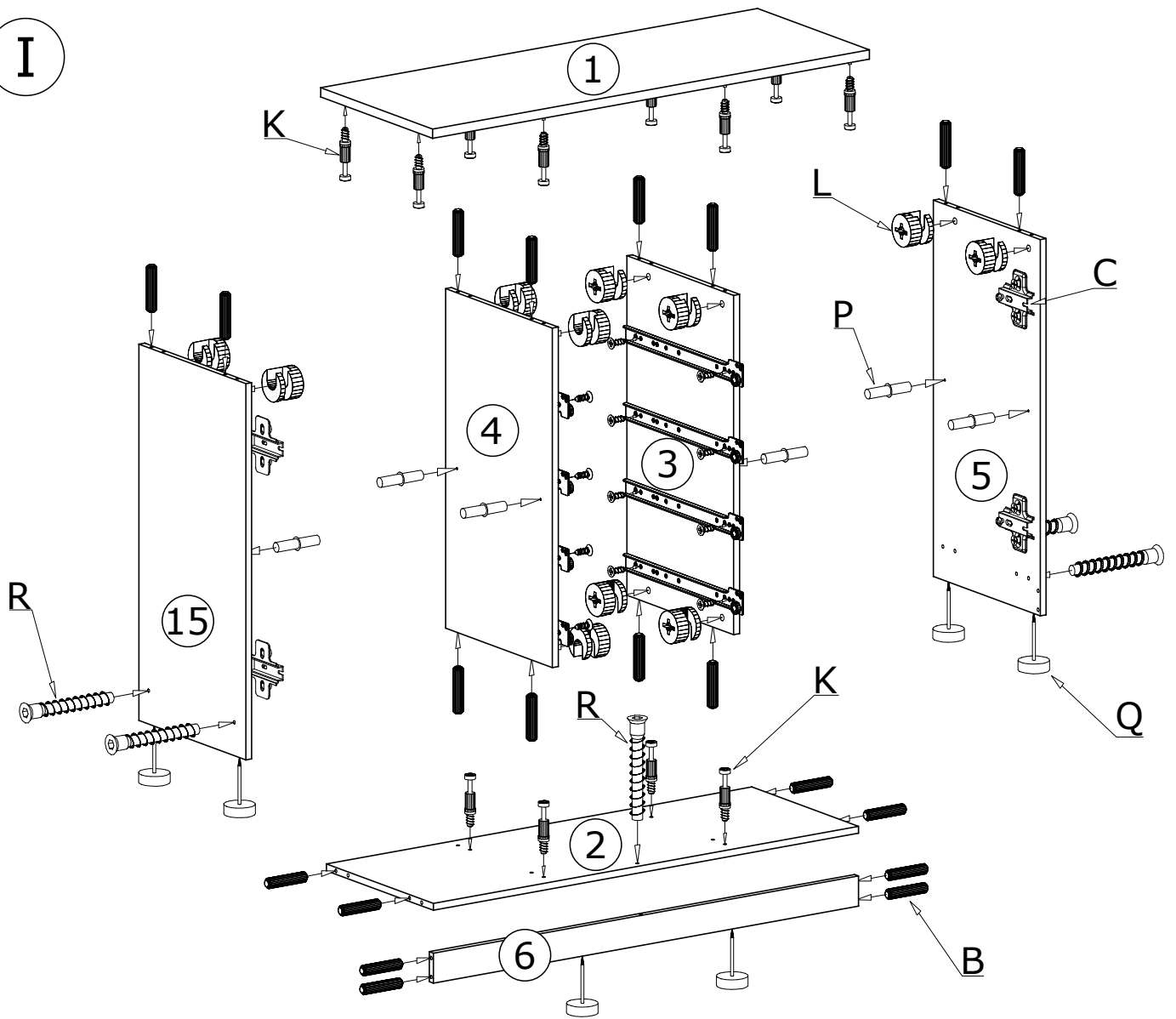

II

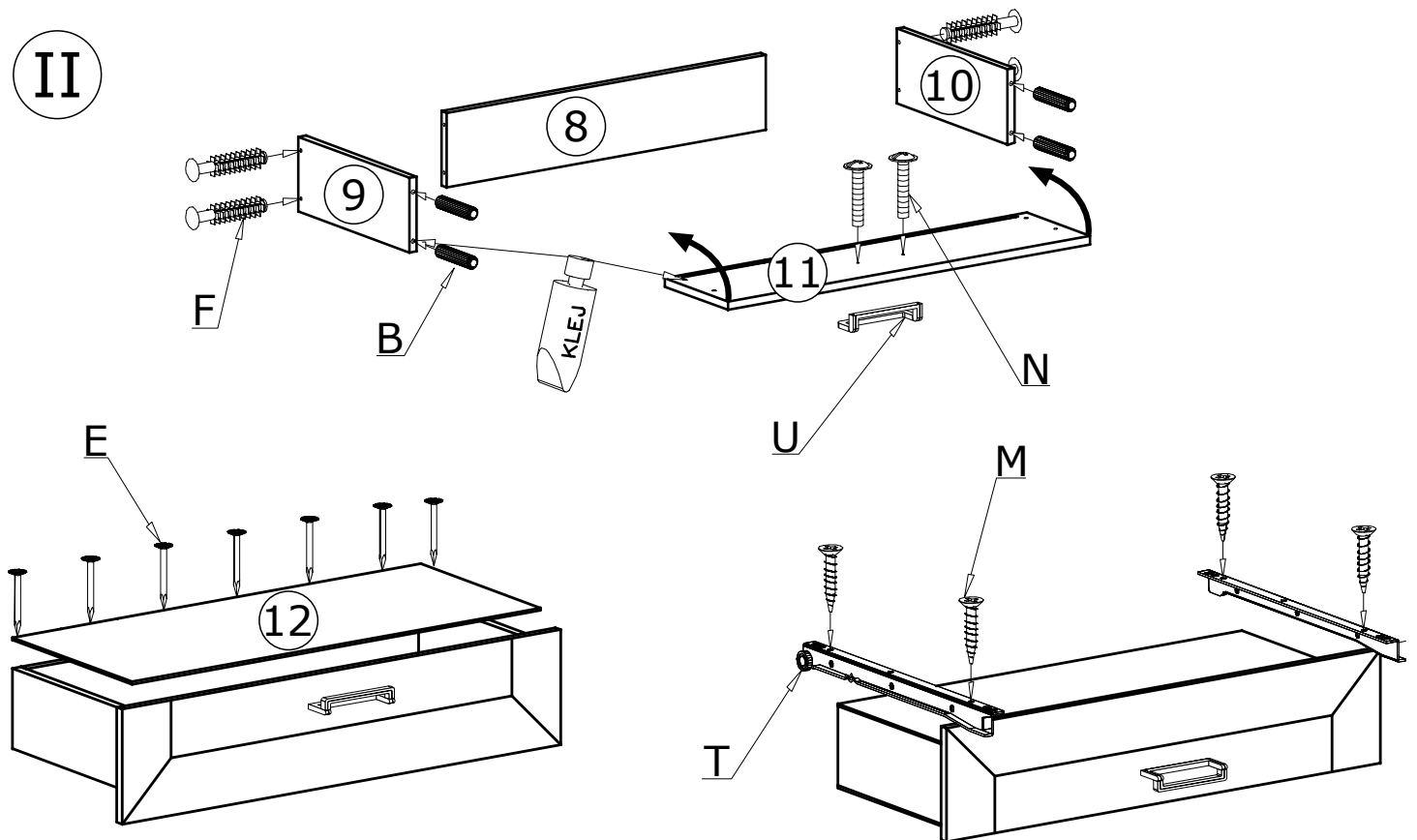

III

120X 

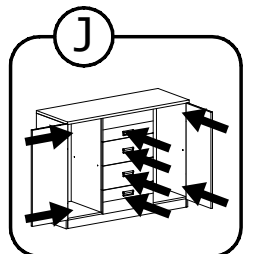
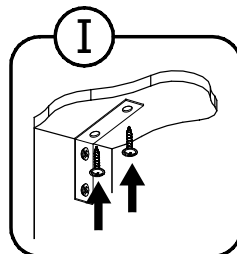
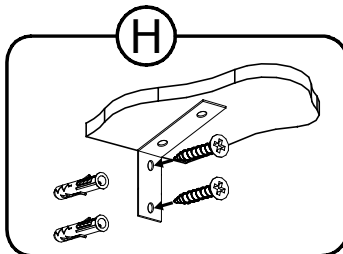
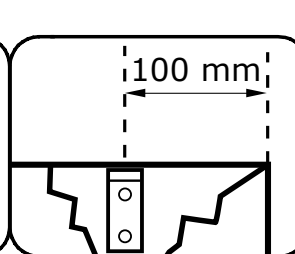
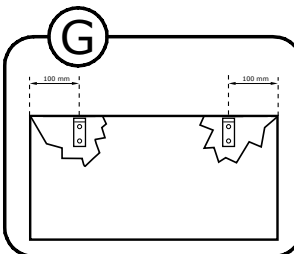
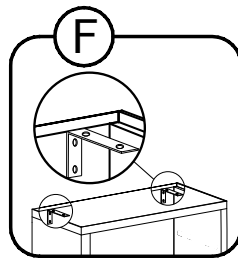
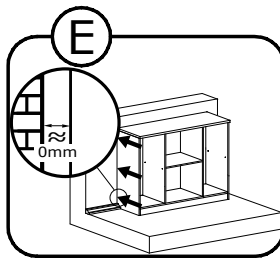
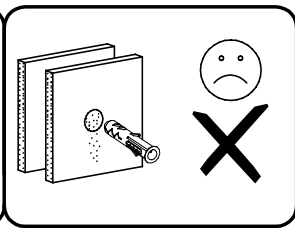
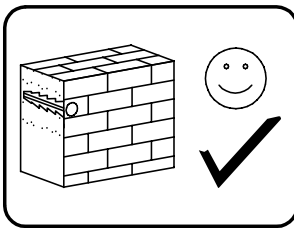
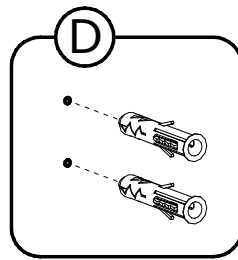
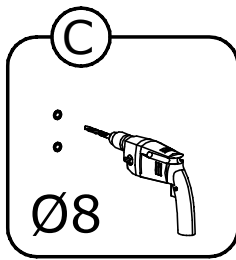
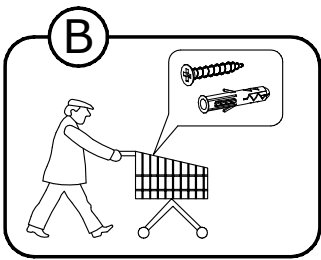
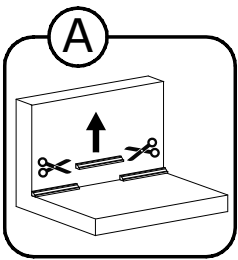
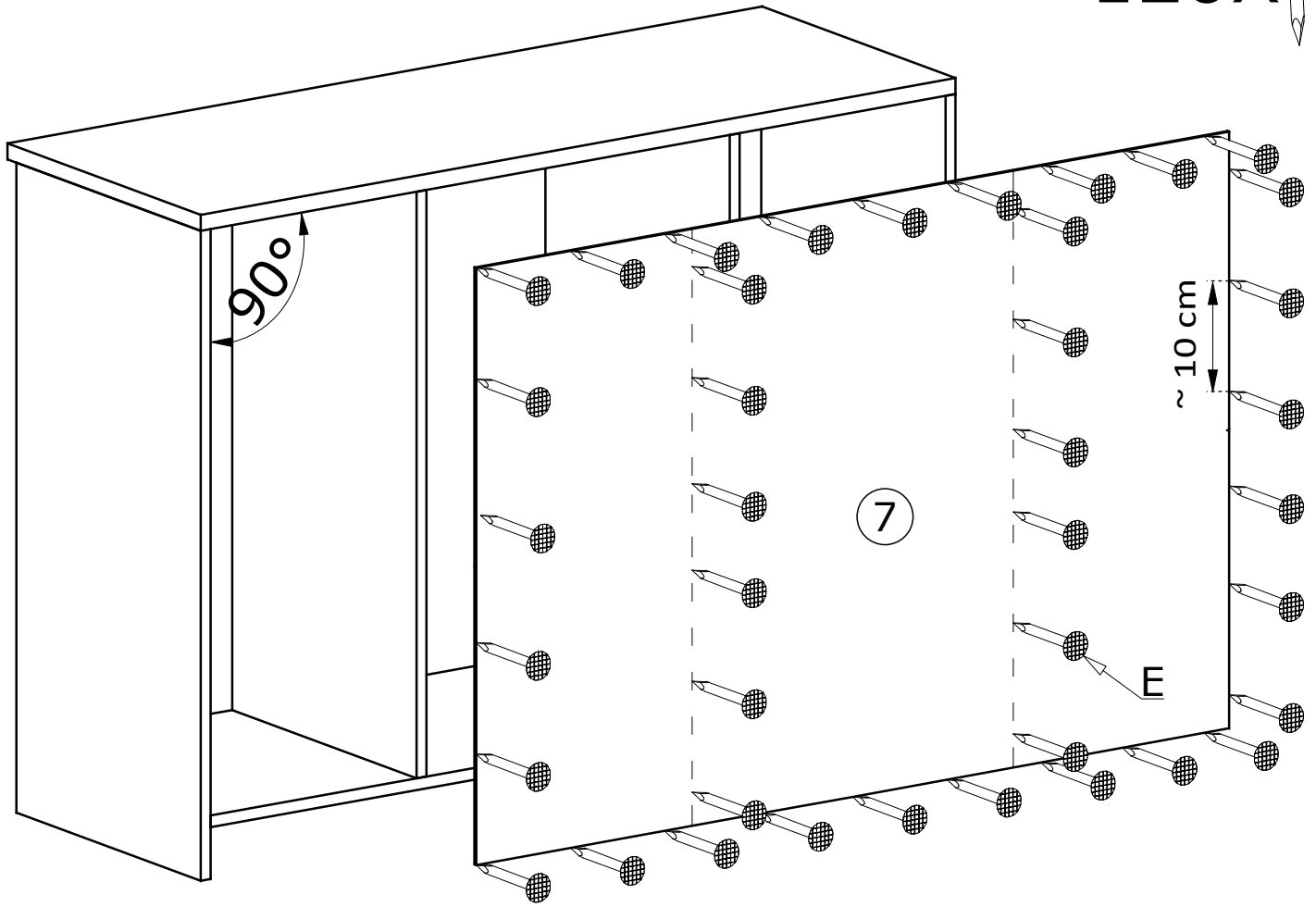

IV

