

PARIS 11

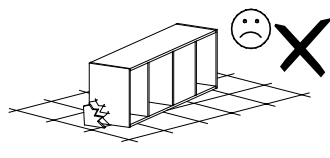

Narzędzia potrzebne do montażu

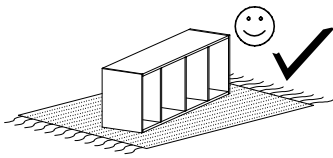
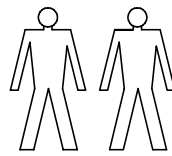
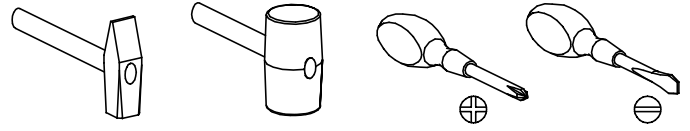

UWAGA !!!

MONTOWANIE USZKODZONYCH
ELEMENTÓW POWODUJE UTRATĘ
GWARANCJI

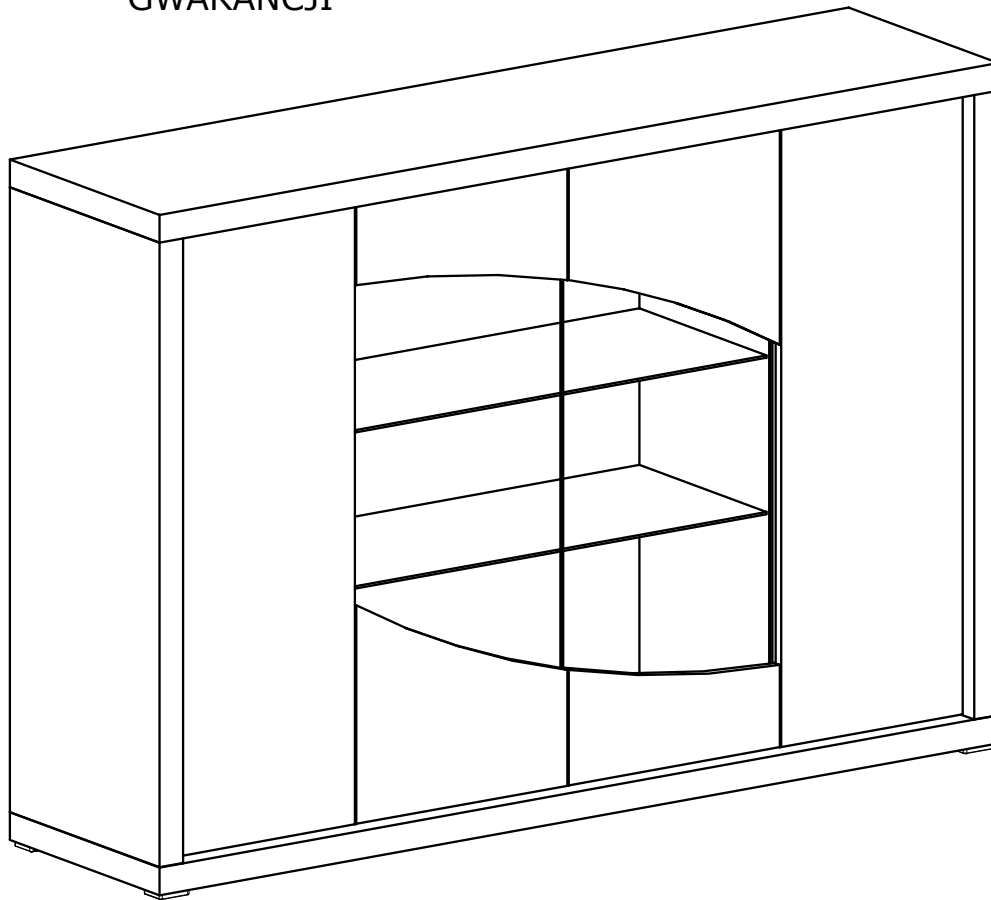

Nr	D[mm]	S[mm]	G[mm]	Ilość
1	1710	436	48	1
2	1710	436	48	1
3	1080	435	48	1
4	1080	388	16	1
5	1080	388	16	1
6	1080	435	48	1
7	395	312	16	4
8	850	370	4	2
9	1138	416	2,5	2
10	770	423	4	2
11	430	200	16	2
12	430	378	16	2
13	1074	370	16	1
14	1074	370	16	1
15	1138	864	2,5	1

W przypadku reklamacji proszę podać numer pakowacza znajdujący się na kartonie.



T - 14 St.

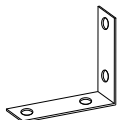

Y - 2 St.

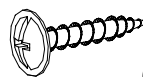

Q - 4 St.
3,5x16 mm

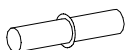

P - 16 St.



N - 12 St.
3,5x25 mm

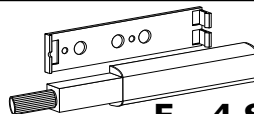

F - 4 St.

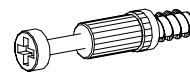

K - 16 St.



L - 16 St.

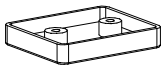

A - 6 St.

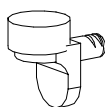

S - 10 St.

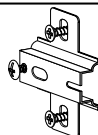

C - 8 St.

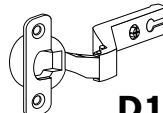

D1 - 4 St.

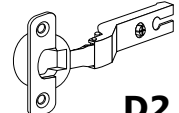

D2 - 4 St.



E - 80 St.



B - 16 St.



G - 54 St.
3,5x16 mm

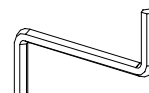

Z - 1 St.

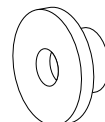

R - 16 St.

I

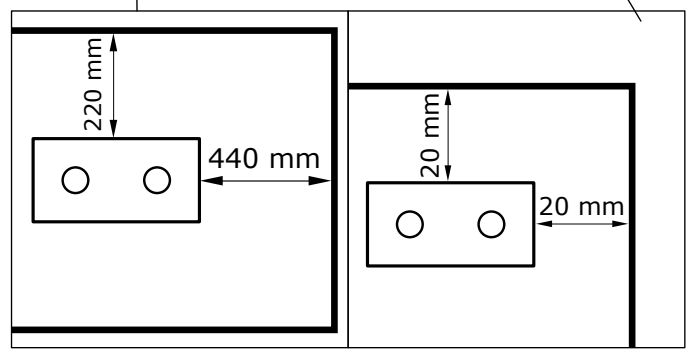
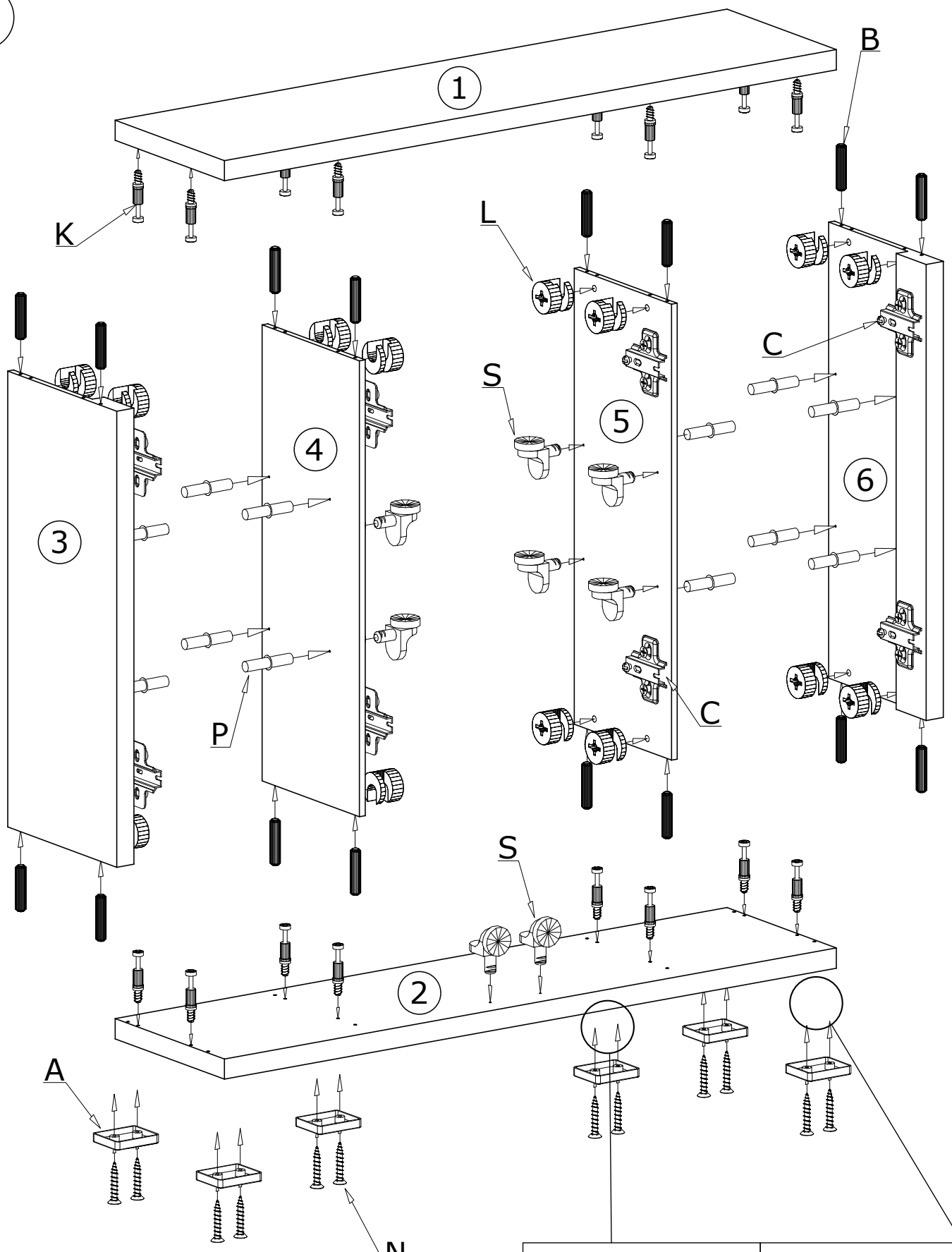

II

80X 

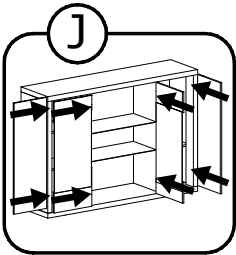
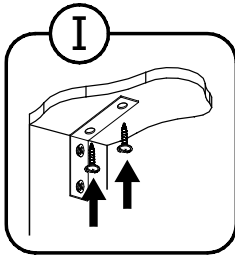
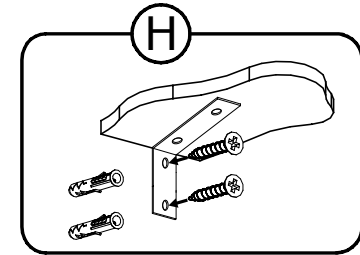
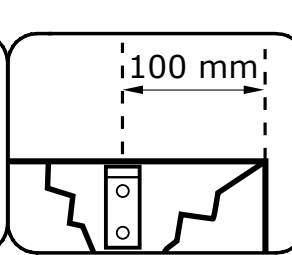
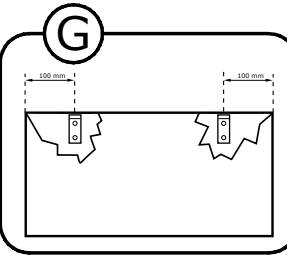
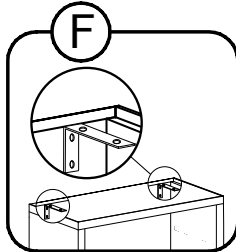
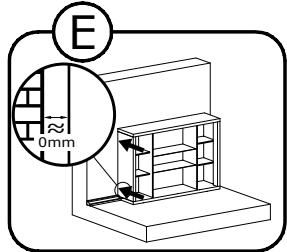
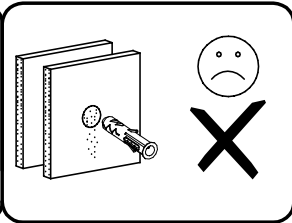
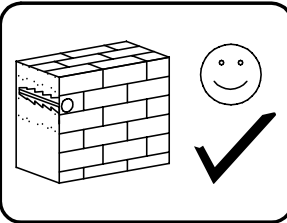
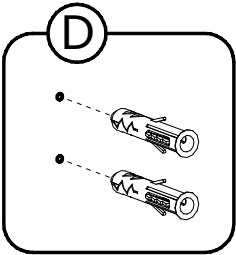
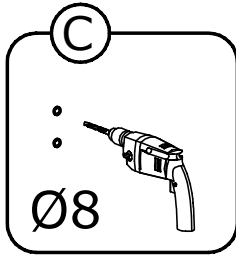
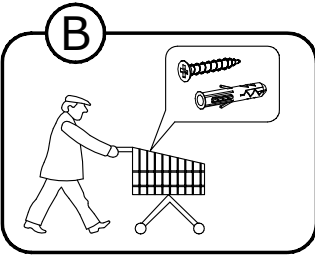
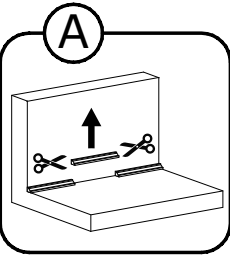
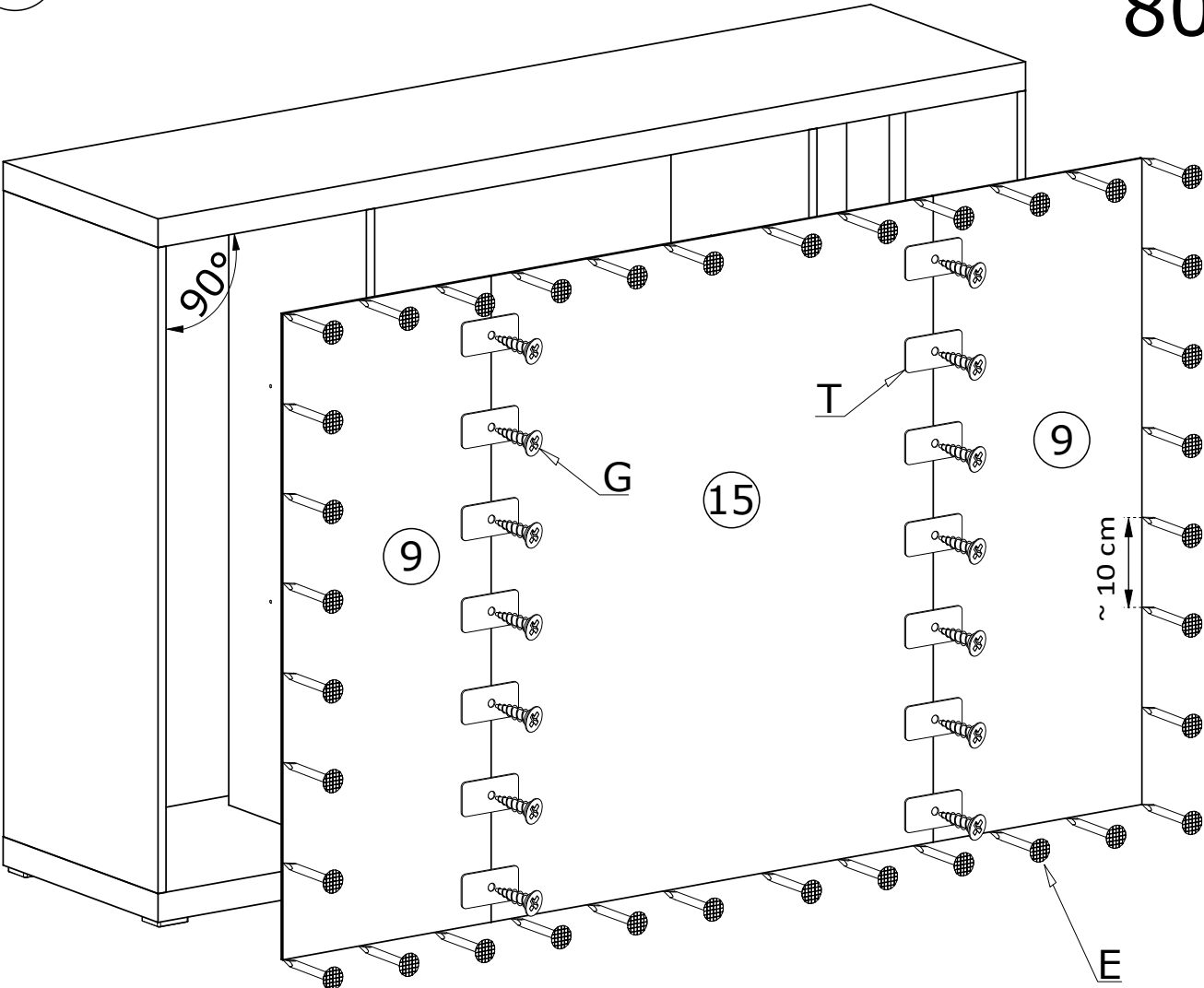

III

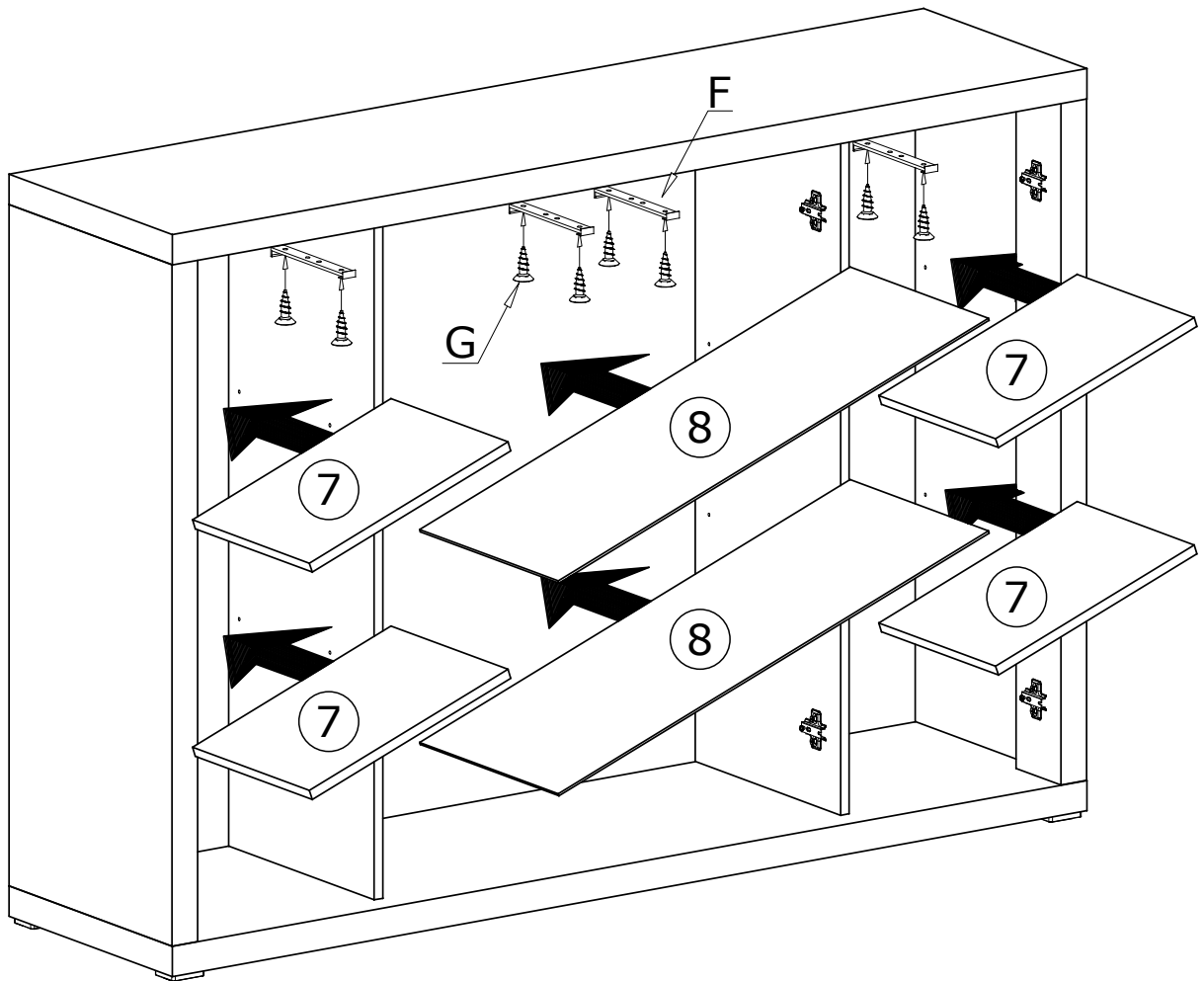

IV

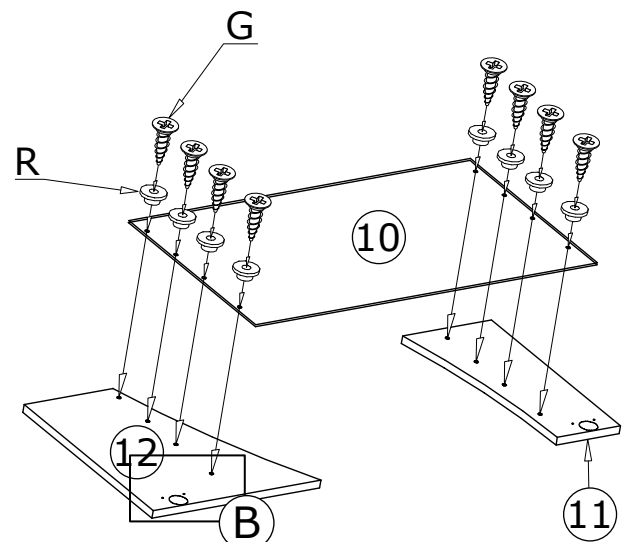
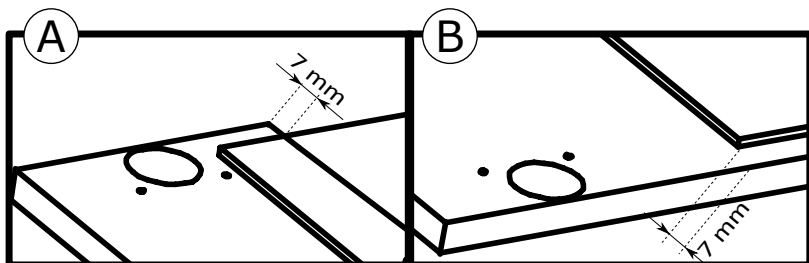
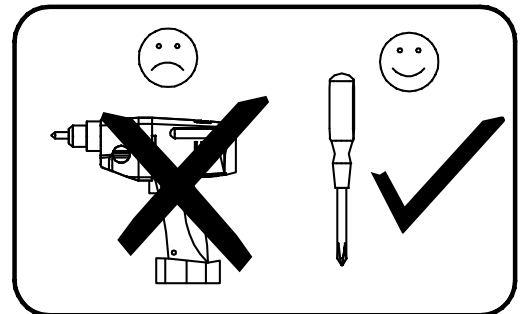
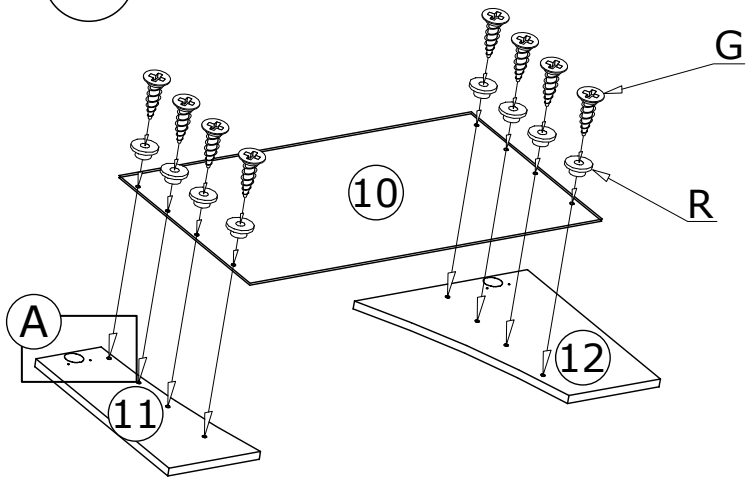

V

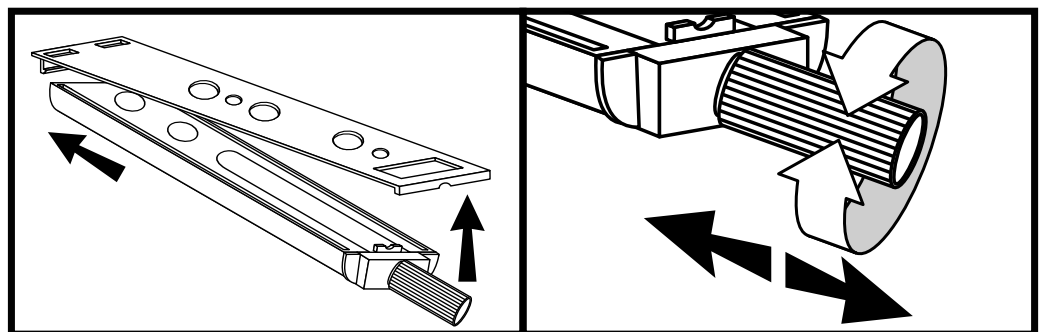
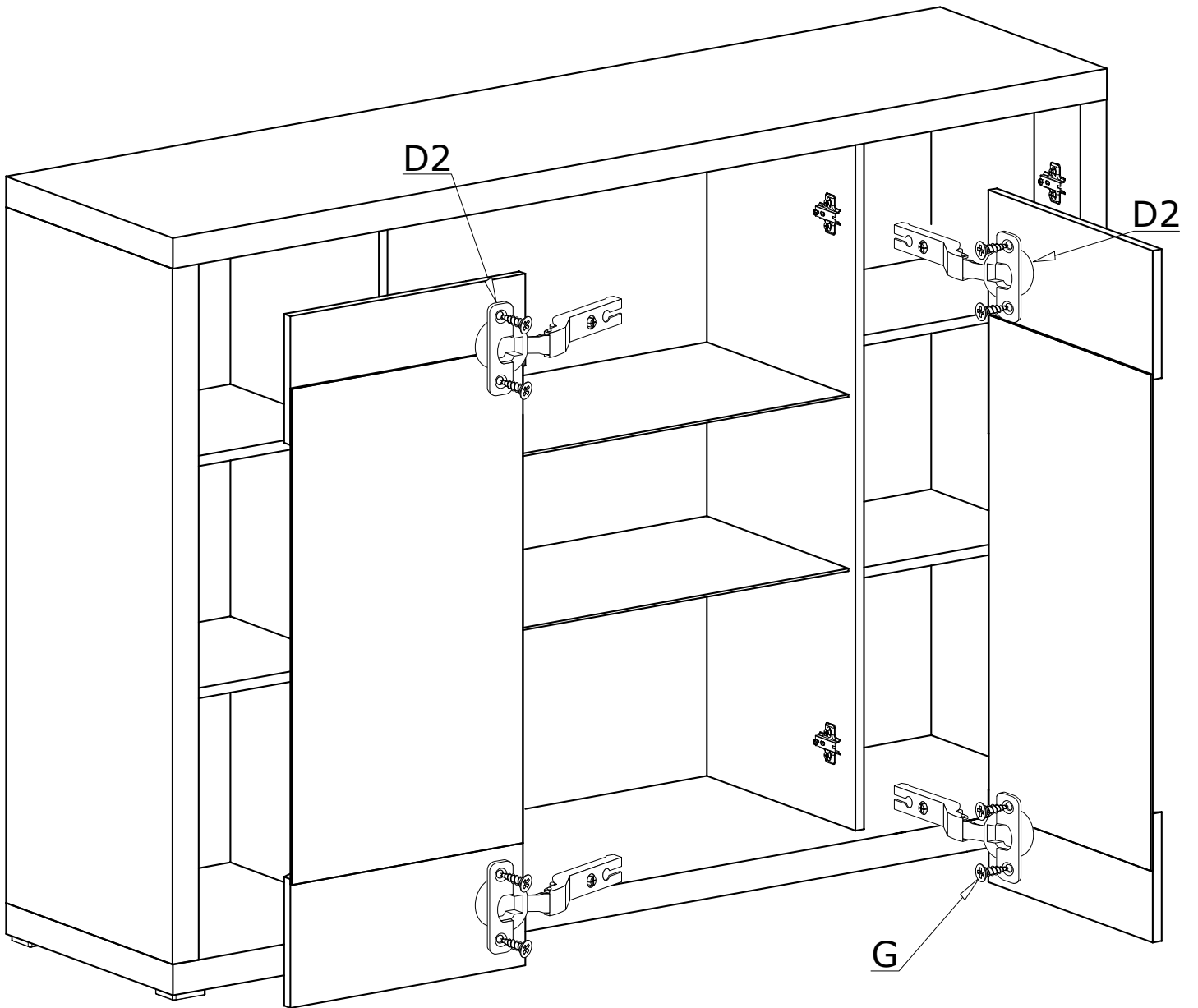

VI

