

NATURAL 14

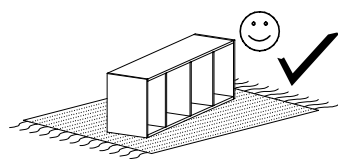

Narzędzia potrzebne do montażu

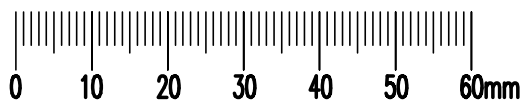
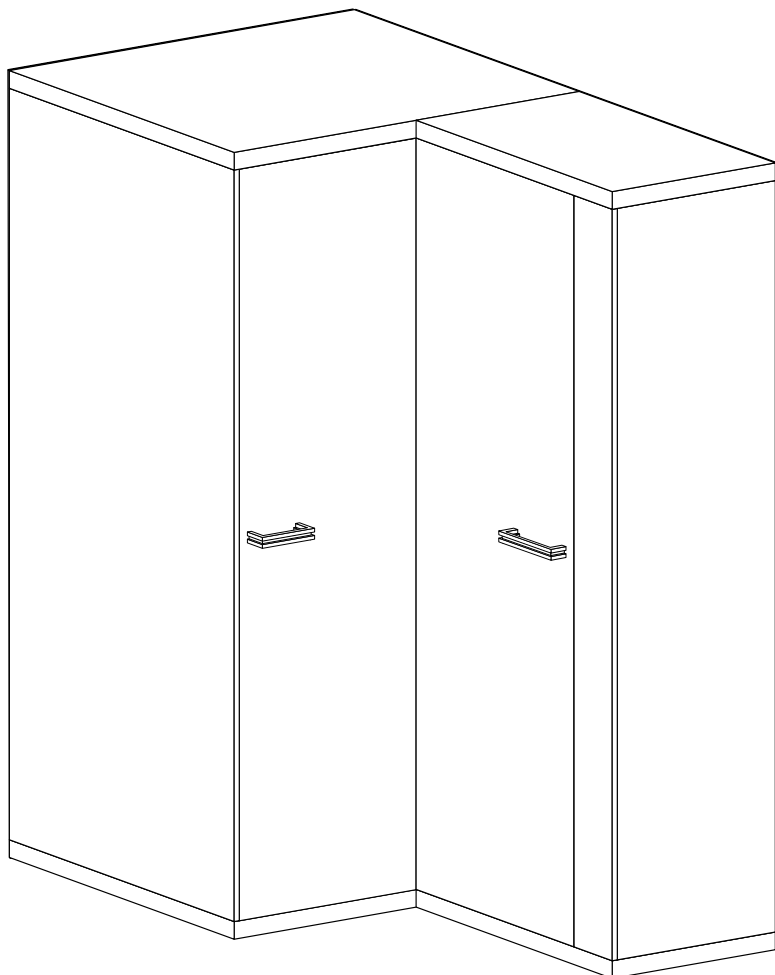
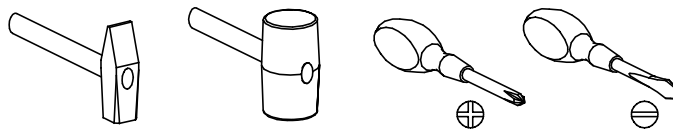

Nr	D[mm]	S[mm]	G[mm]	Ilość
1	1900	538	16	1
2	1900	389	16	1
3	872	538	48	1
4	552	406	16	1
5	872	538	48	1
6	552	406	48	1
7	1900	405	16	1
8	1900	400	16	1
9	840	120	16	1
10	1900	100	16	1
11	840	400	16	1
12	536	320	48	4
13	1950	430	2,5	2
14	1950	360	2,5	2
15	1894	445	16	2

UWAGA !!!

MONTOWANIE USZKODZONYCH
ELEMENTÓW POWODUJE UTRATĘ
GWARANCJI

W przypadku reklamacji proszę podać numer pakowacza znajdujący się na kartonie.

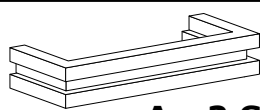

A - 2 St.

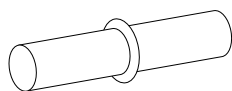

B - 20 St.

UWAGA !!!

Mebel zawiera
elementy drewniane

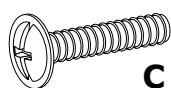

C - 4 St.
4x25 mm

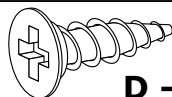

D - 35 St.
3,5x16 mm



E - 22 St.

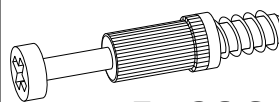

F - 26 St.

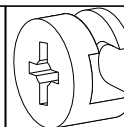

G - 31 St.

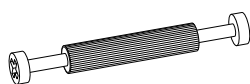

H - 6 St.



I - 90 St.

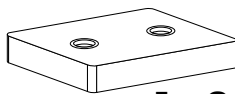

J - 8 St.

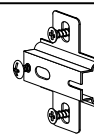

K - 6 St.

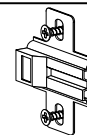

L - 2 St.

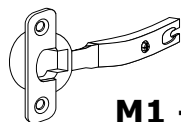

M1 - 3 St.

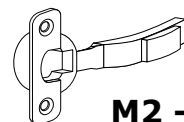

M2 - 1 St.

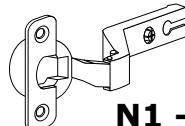

N1 - 3 St.

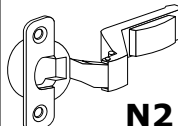

N2 - 1 St.

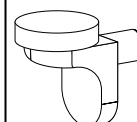

O - 2 St.

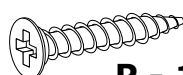

P - 16 St.
3,5x25 mm

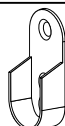

R - 2 St.

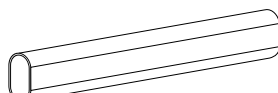

S - 1 St.



T - 6 St.

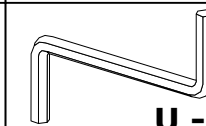

U - 1 St.

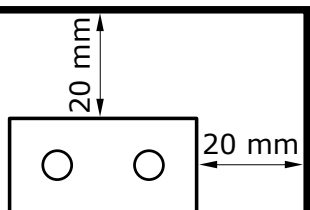
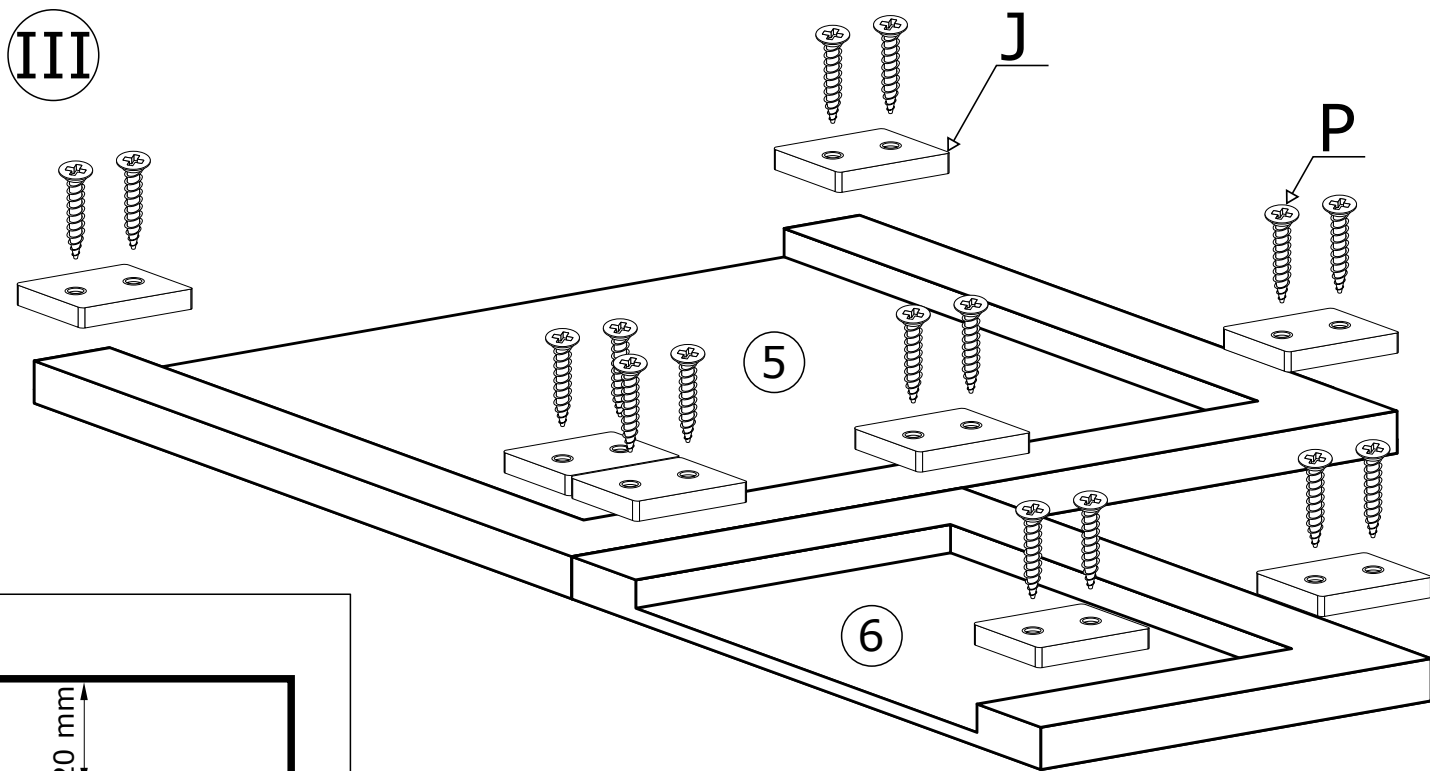
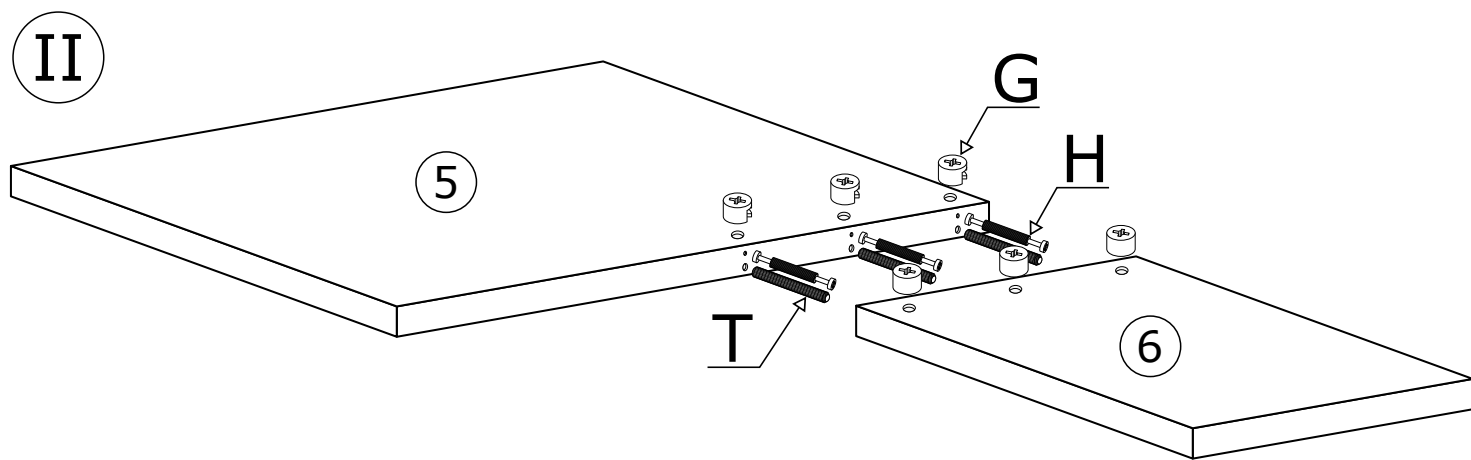
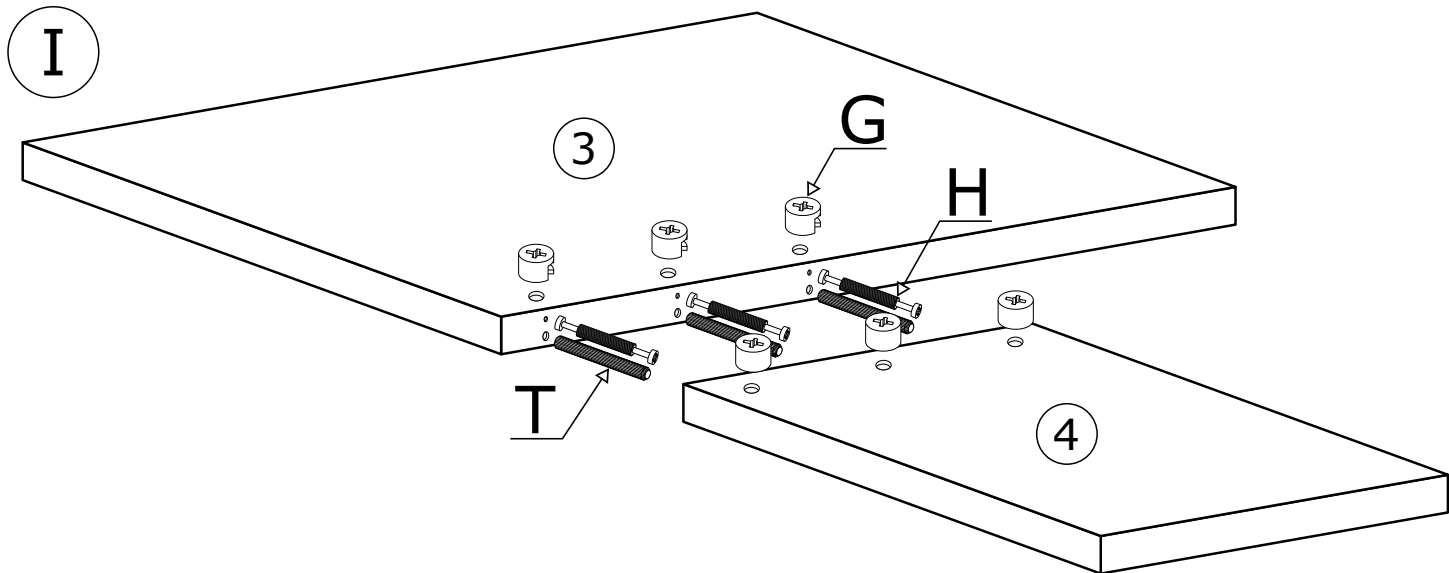

IV

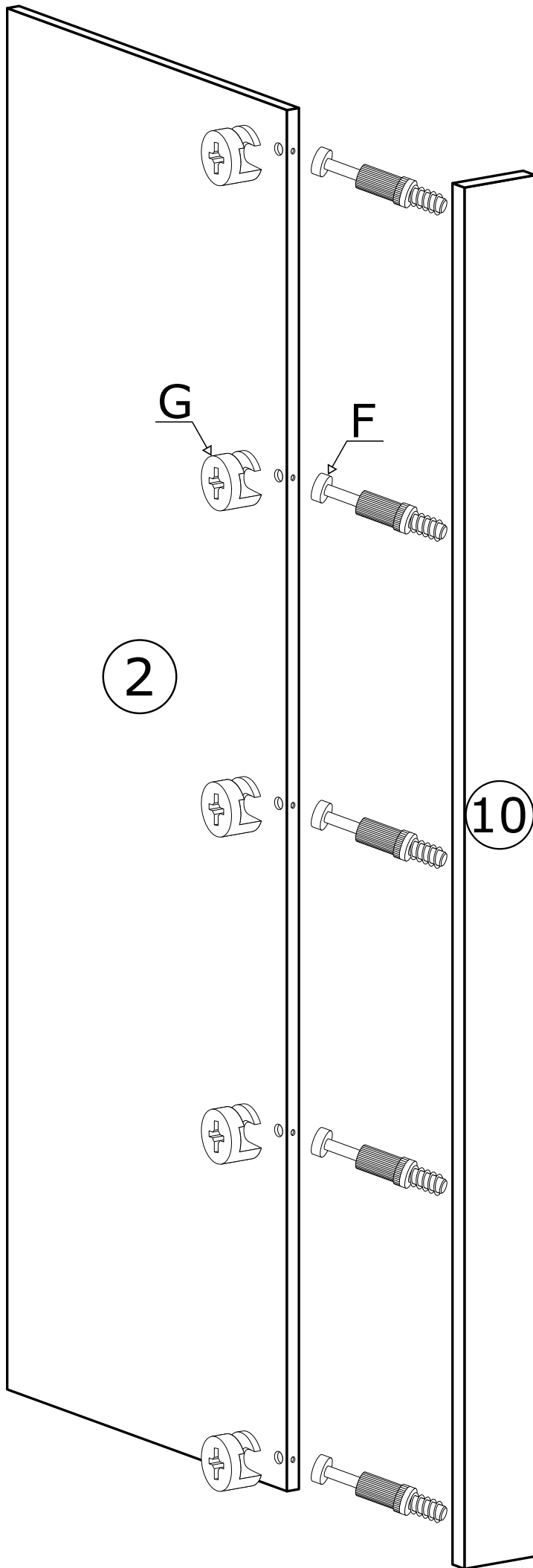

V

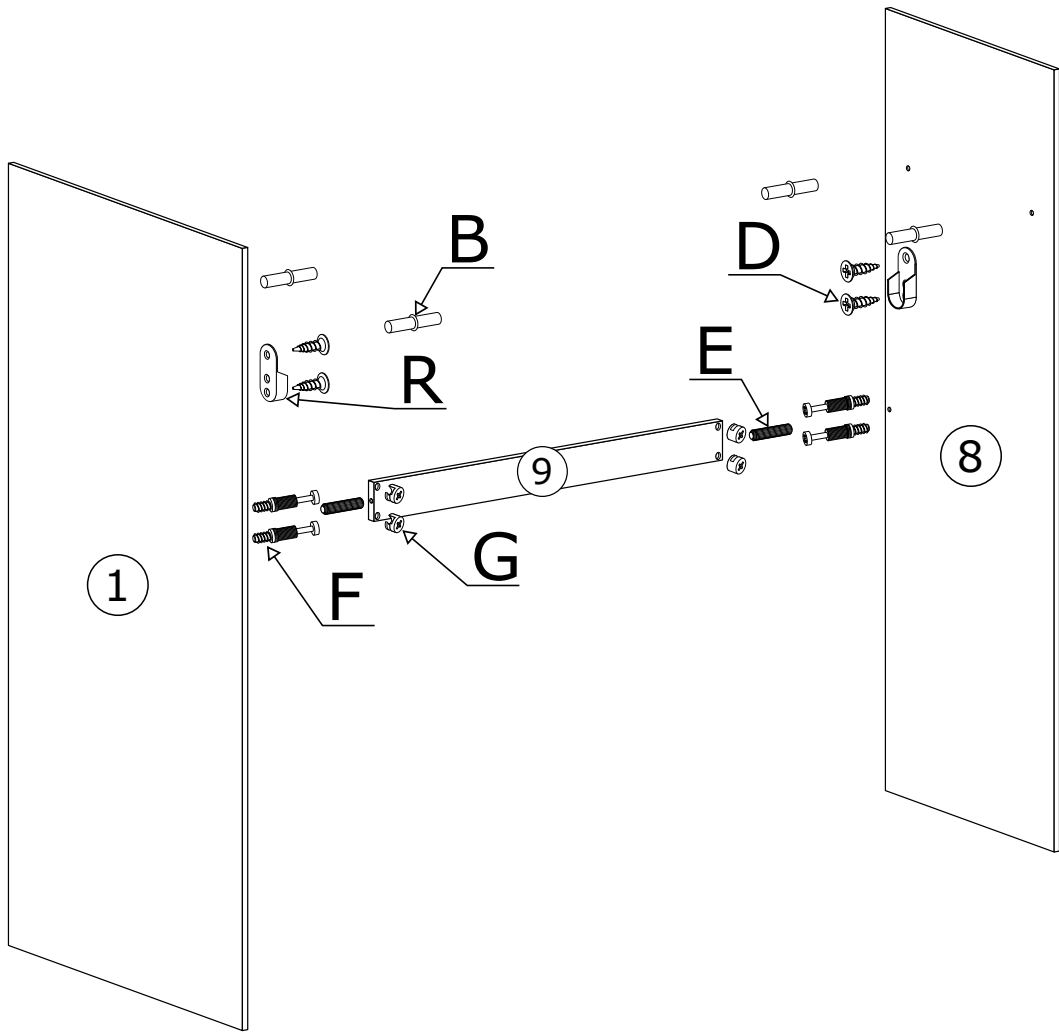

VI

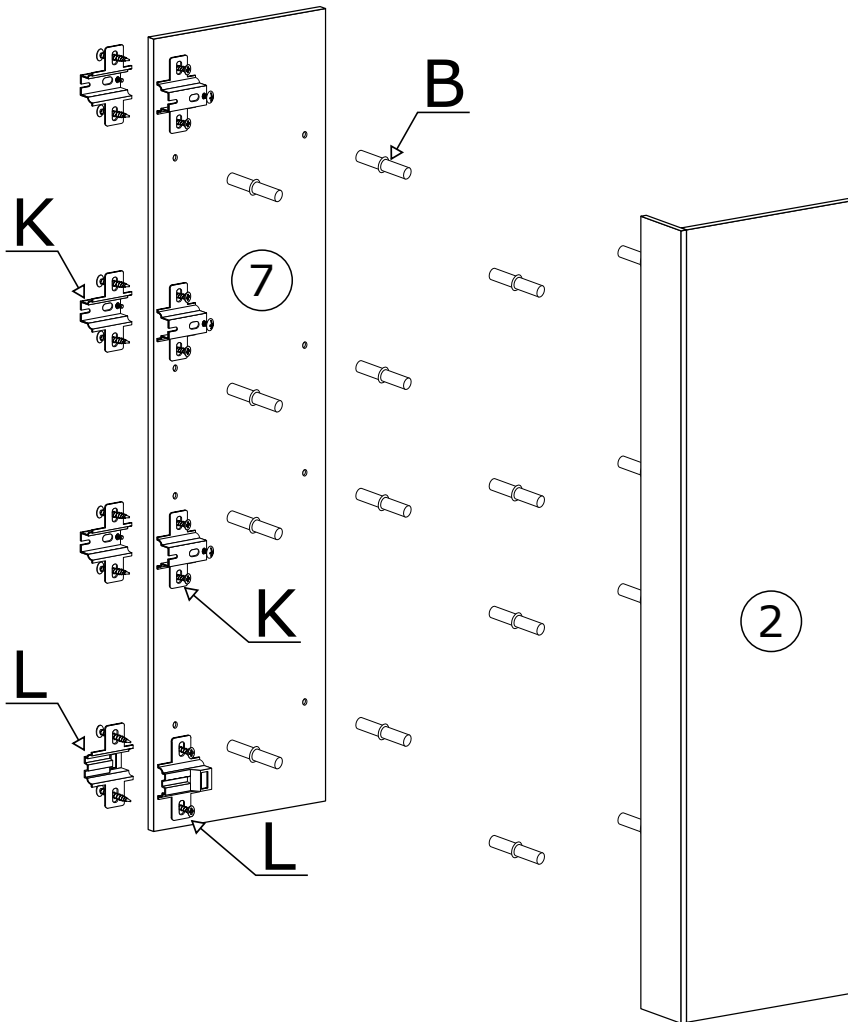

VII

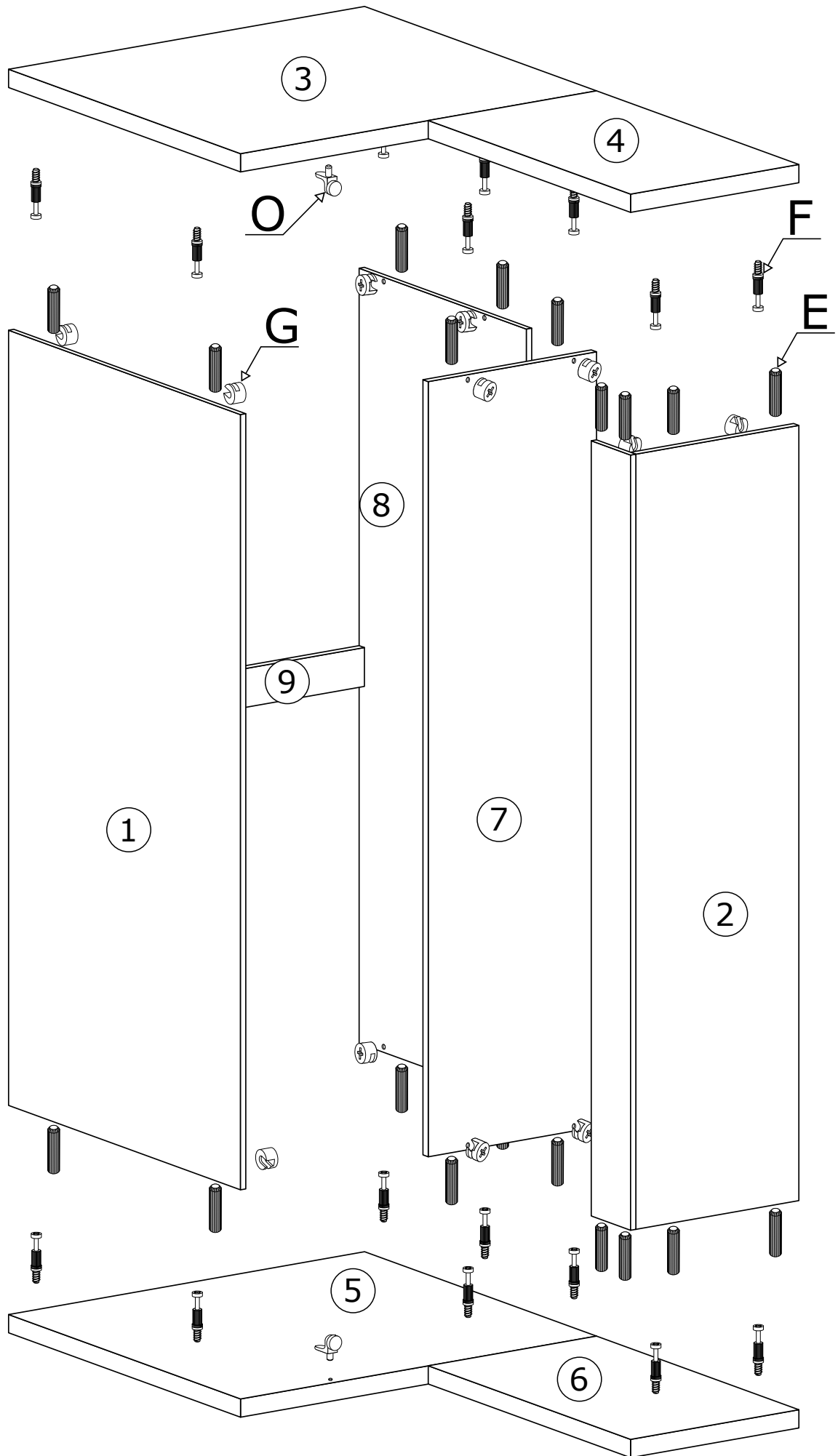

VIII

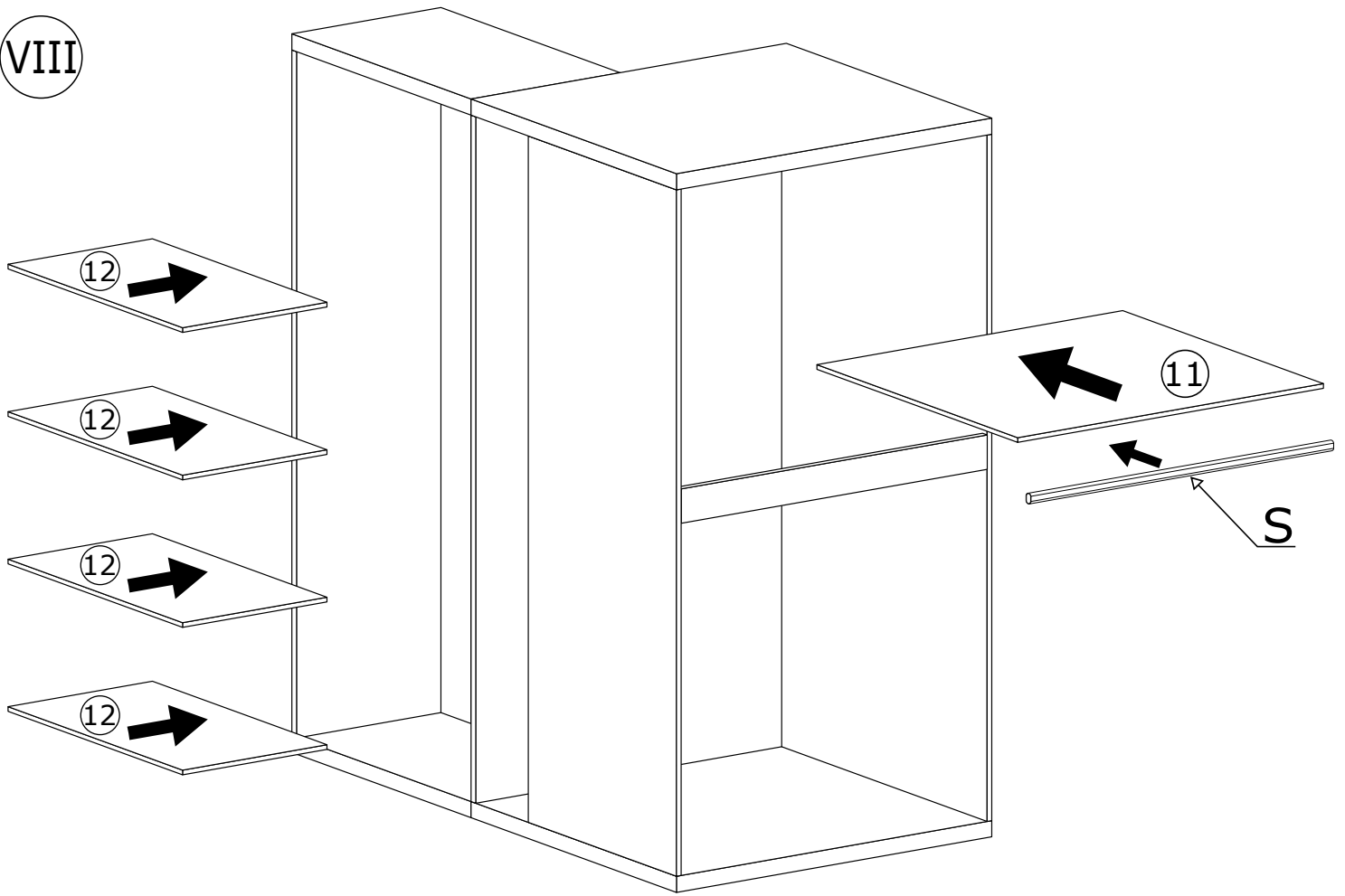

IX

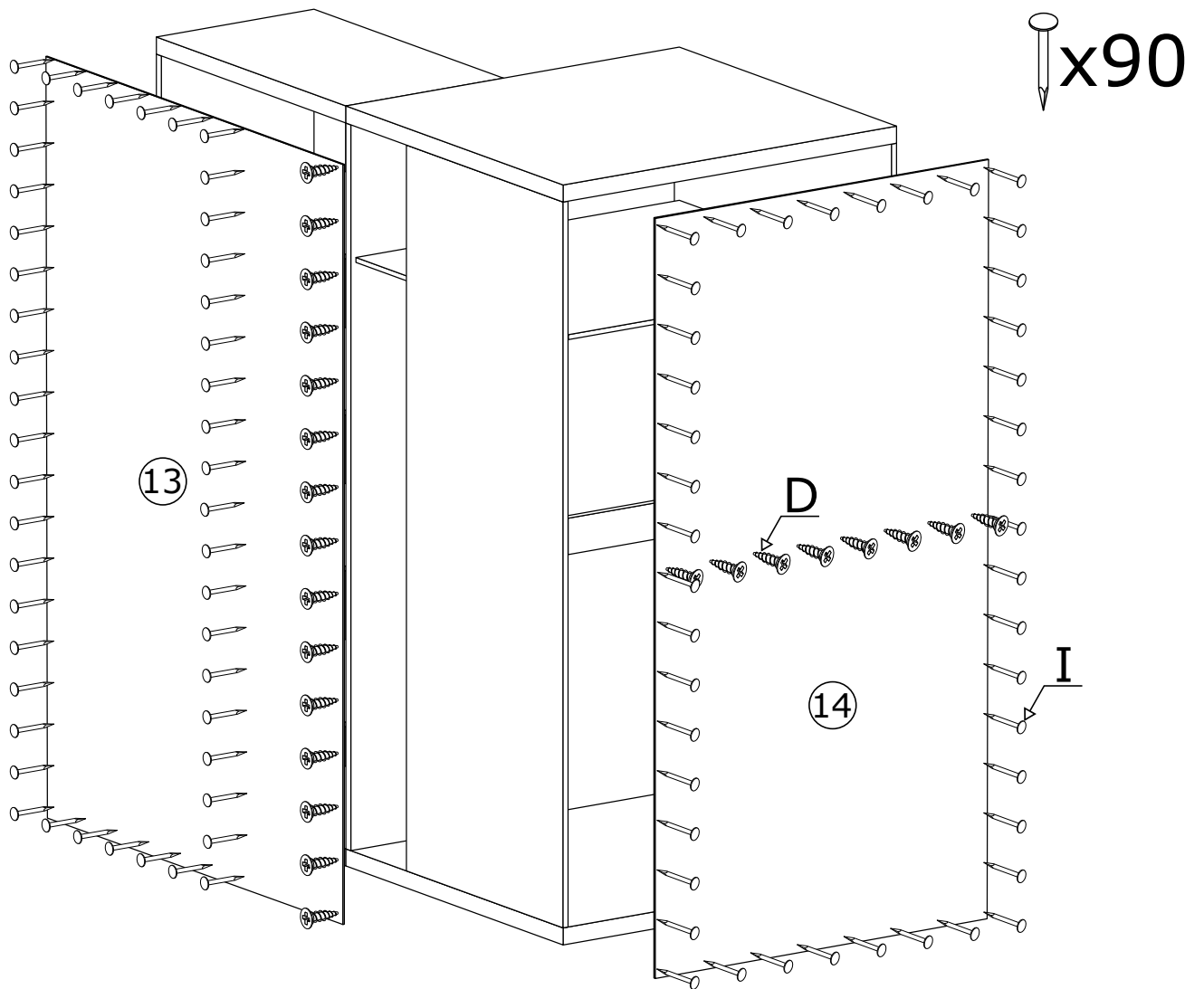

X

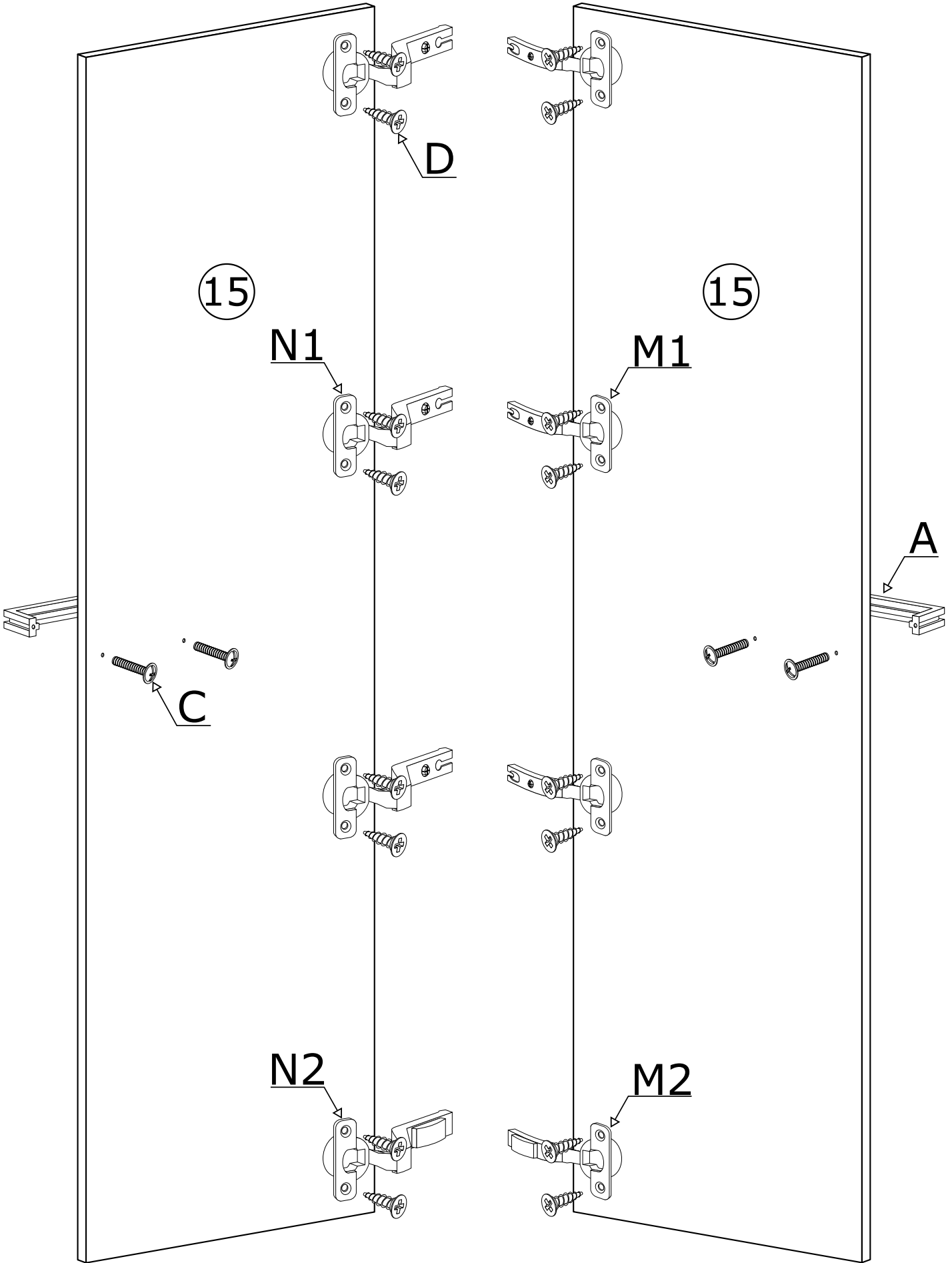

XI

