

NATURAL 1



Narzędzia potrzebne do montażu



UWAGA !!!

MONTOWANIE USZKODZONYCH
ELEMENTÓW POWODUJE UTRATĘ
GWARANCJI

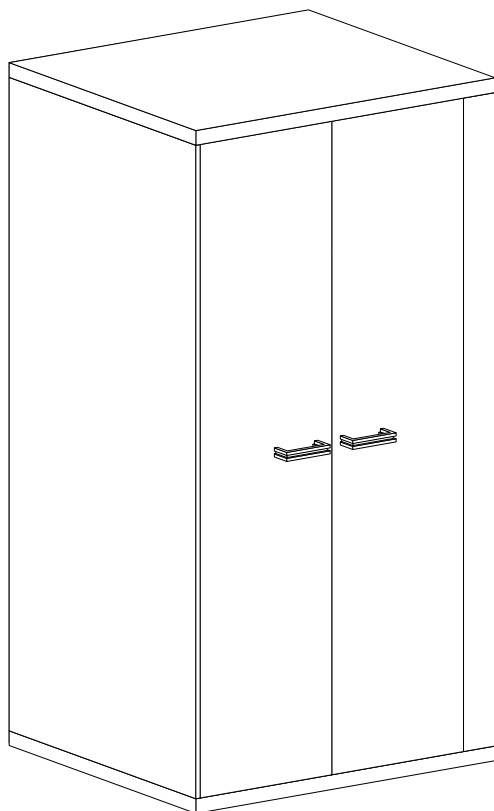

Nr	D[mm]	S[mm]	G[mm]	Ilość
1	1900	576	16	1
2	1900	560	16	1
3	1018	577	48	1
4	1018	577	48	1
5	983	560	16	1
6	983	120	16	1
7	1900	100	16	1
8	1950	1100	2,5	1
9	1894	445	16	2

W przypadku reklamacji proszę podać numer pakowacza znajdujący się na kartonie.

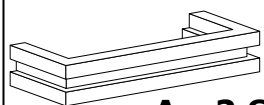

A - 2 St.

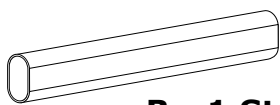

B - 1 St.

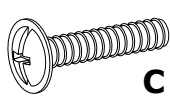

C - 4 St.
4x25 mm

UWAGA !!!
Mebel zawiera
elementy drewniane

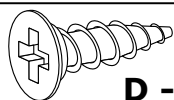

D - 28 St.
3,5x16 mm

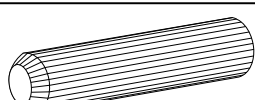

E - 18 St.

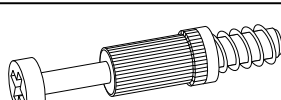

F - 21 St.



G - 21 St.

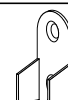

H - 2 St.

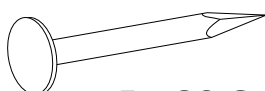

I - 80 St.

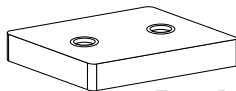

J - 4 St.

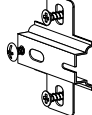

K - 6 St.

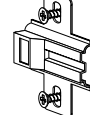

L - 2 St.

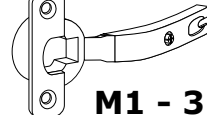

M1 - 3 St.

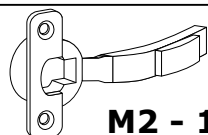

M2 - 1 St.

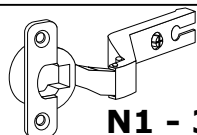

N1 - 3 St.

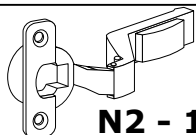

N2 - 1 St.

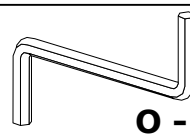

O - 1 St.

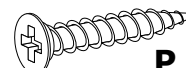

P - 8 St.
3,5x25 mm

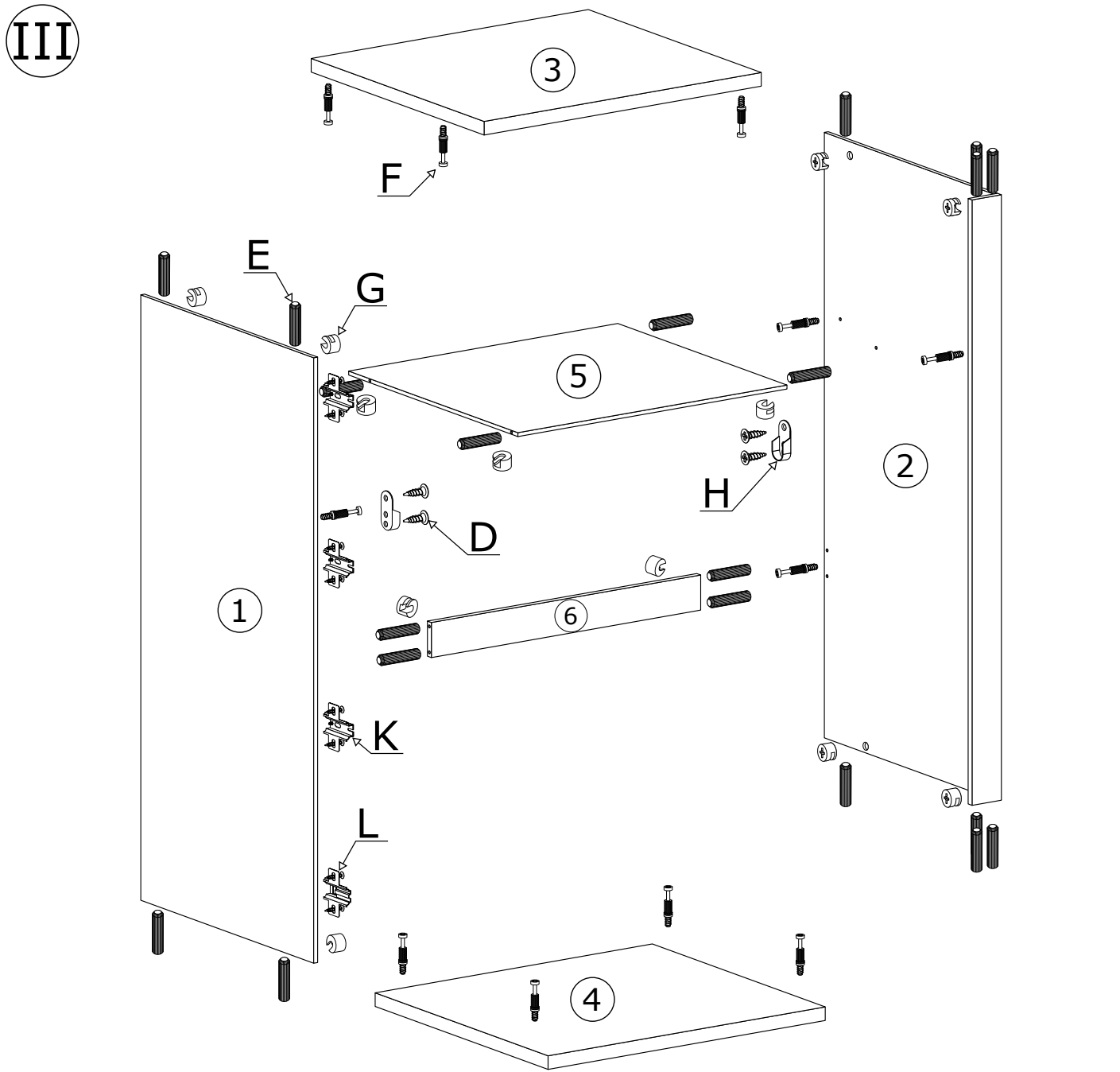
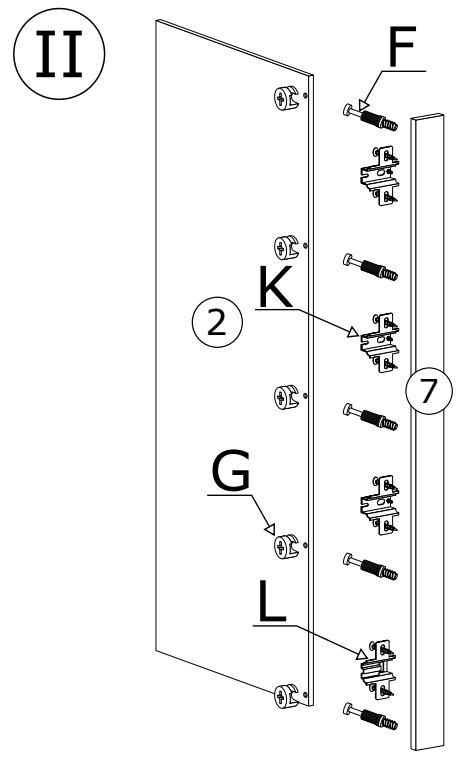
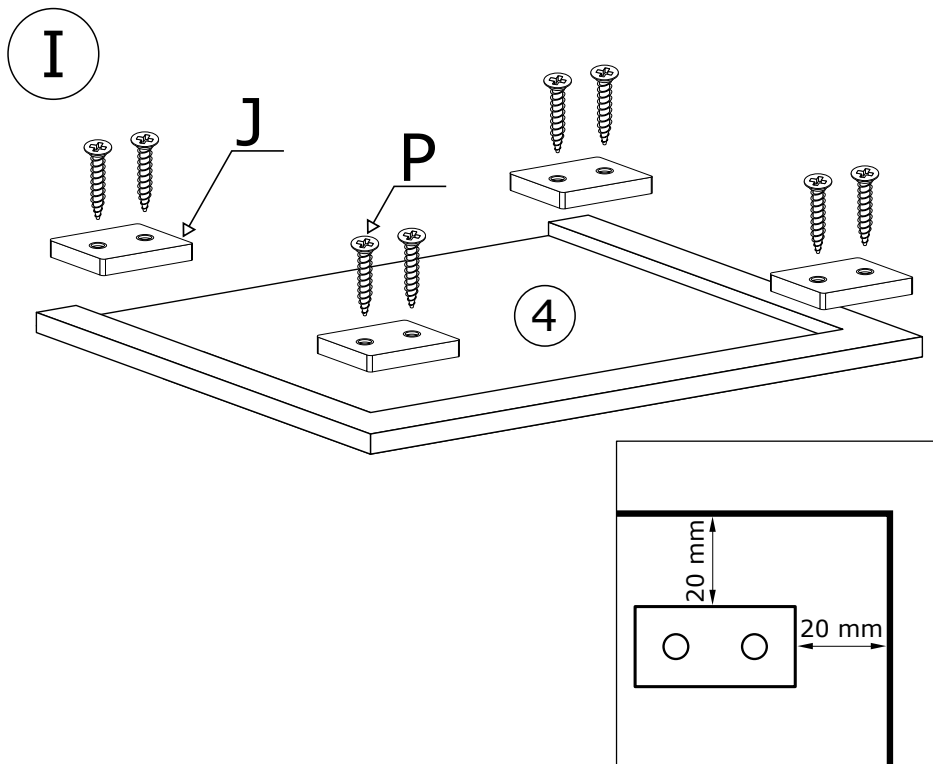

IV

x80

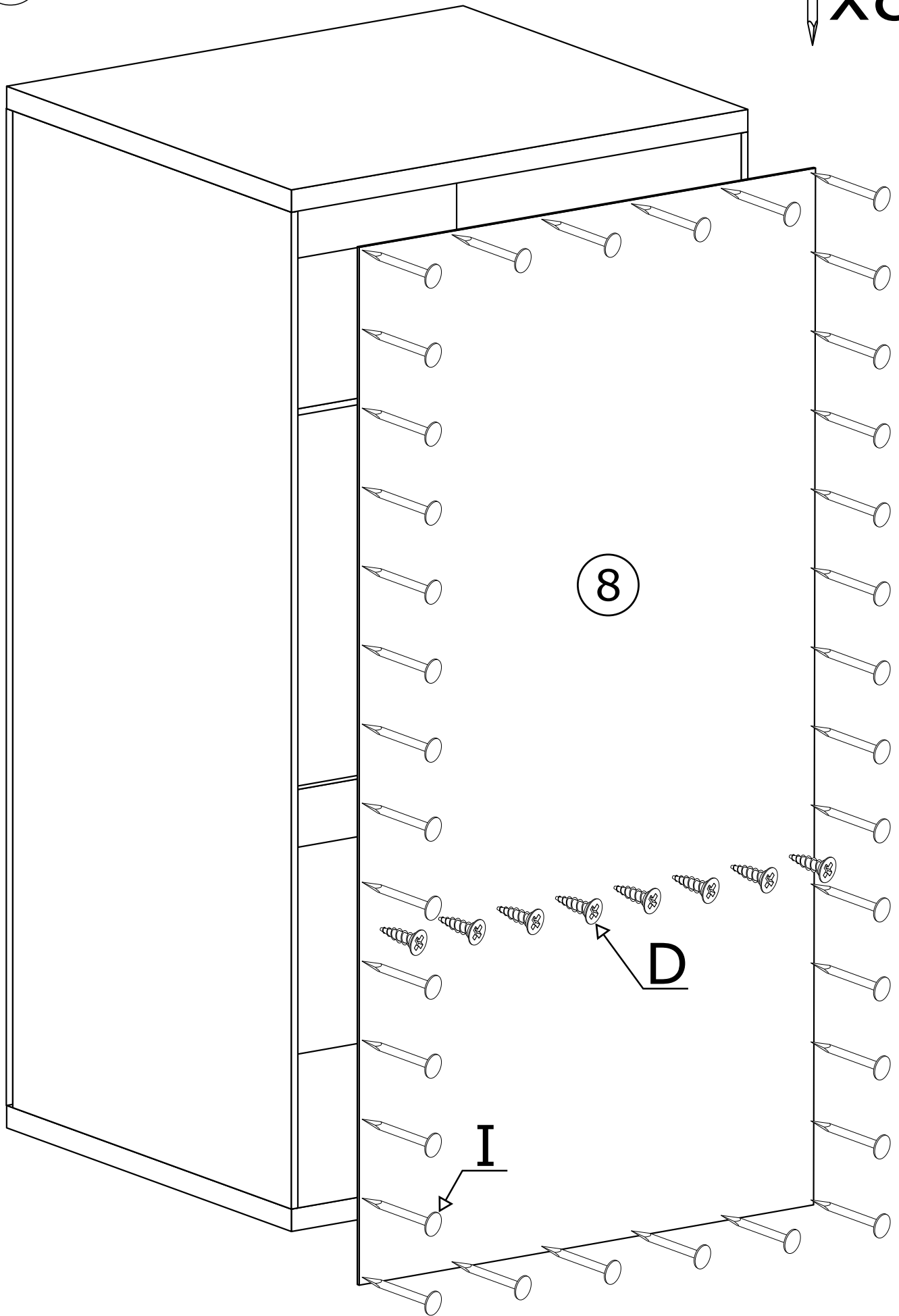

V

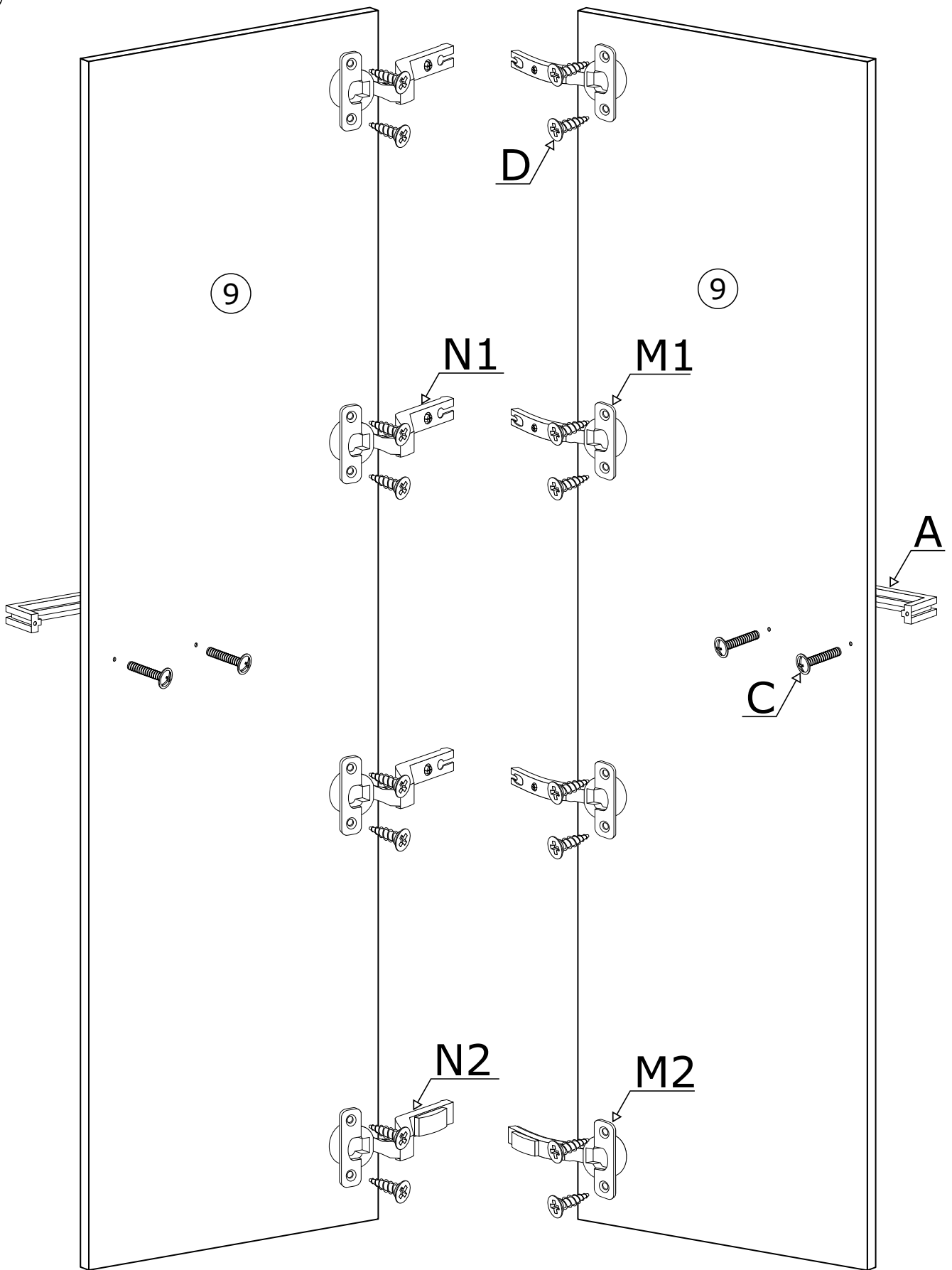

VI

