

DALLAS 21

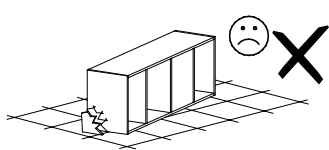

Narzędzia potrzebne do montażu

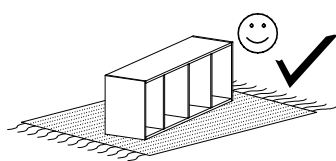
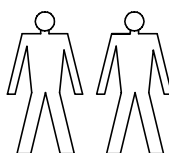
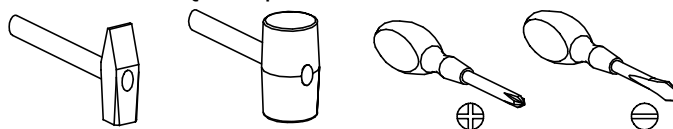

UWAGA !!!

MONTOWANIE USZKODZONYCH
ELEMENTÓW POWODUJE UTRATĘ
GWARANCJI

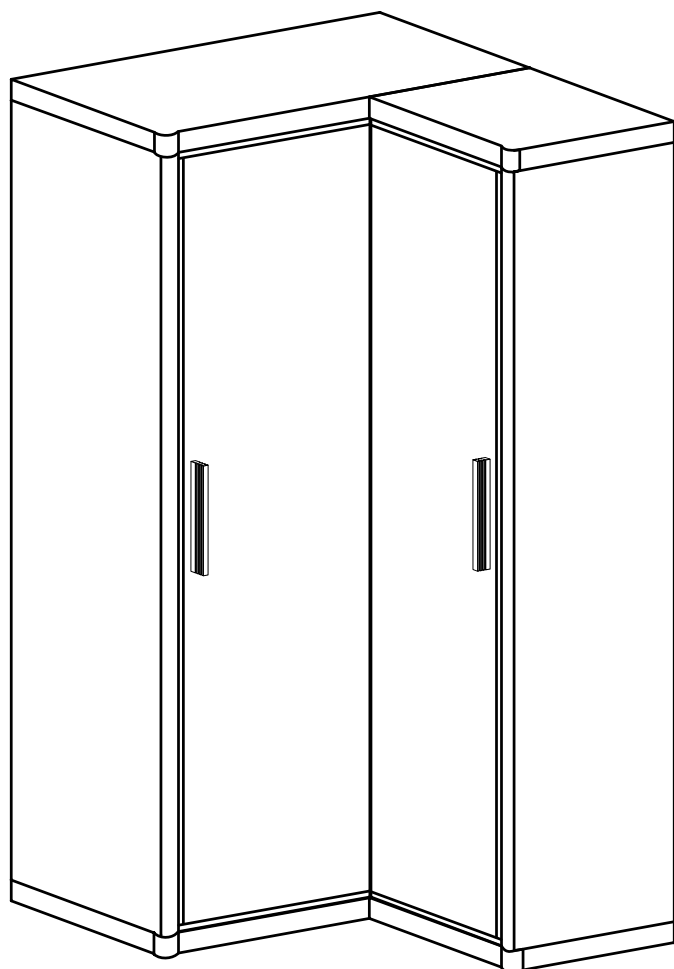

Nr	D[mm]	S[mm]	G[mm]	Ilość
1	553	450	48	1
2	1000	590	48	1
3	1000	590	48	1
4	553	450	48	1
5	1810	423	16	1
6	1810	562	16	1
7	1810	100	32	1
8	1810	100	32	1
9	1810	435	16	1
10	1810	400	16	1
11	966	400	16	1
12	548	380	16	1
13	548	380	16	4
14	1835	990	2,5	1
15	1835	840	2,5	1
16	1780	463	16	1
17	1780	463	16	1

W przypadku reklamacji proszę podać numer pakowacza znajdujący się na kartonie.

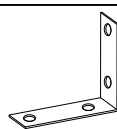

Y - 2 St.

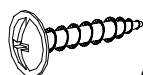

Q - 4 St.
3,5x16 mm

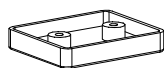

A - 7 St.

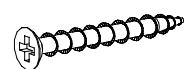

R - 14 St.
4x25 mm



M - 1 St.

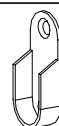

T - 2 St.

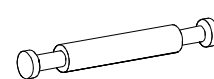

F - 6 St.



S - 6 St.



N - 4 St.
4x30 mm



U - 2 St.



G - 37 St.
3,5x16 mm

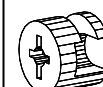

L - 38 St.

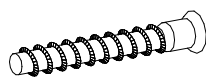

W - 2 St.



E - 100 St.

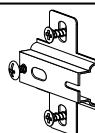

C - 8 St.

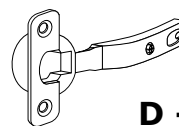

D - 4 St.



Z - 1 St.



P - 20 St.

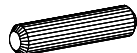

B - 20 St.

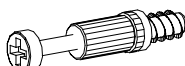

K - 26 St.



Z - 1 St.

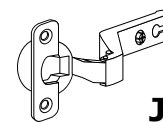

J - 4 St.

I

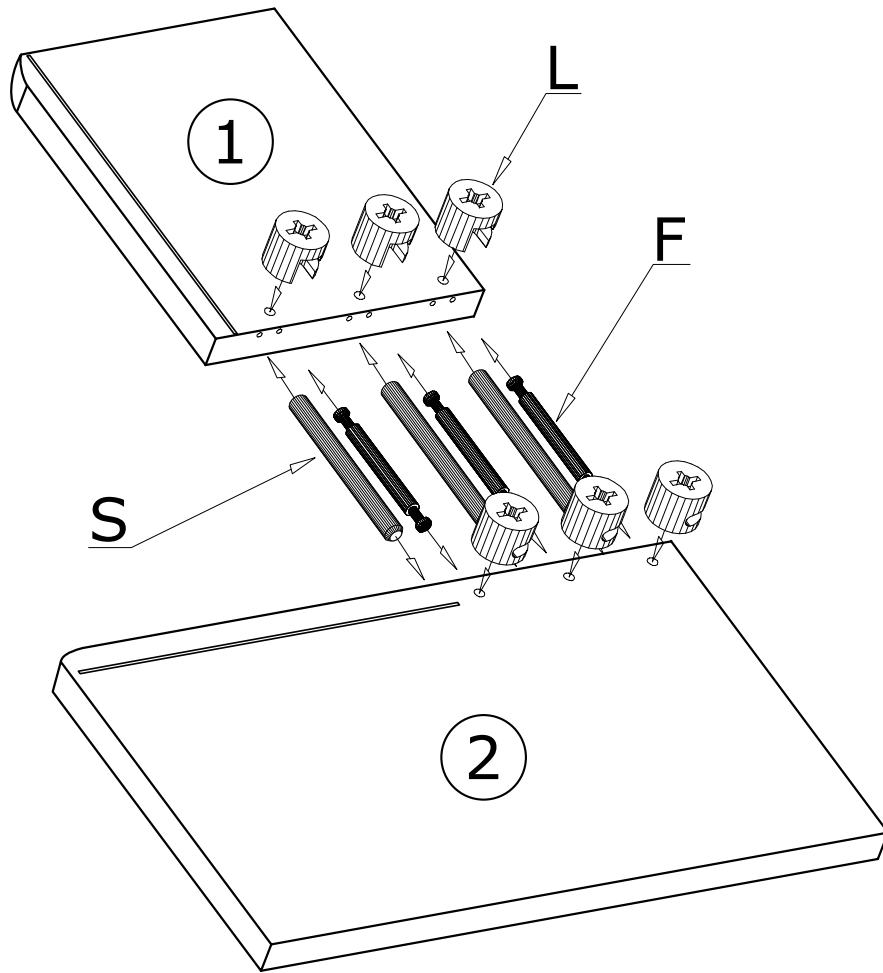

II

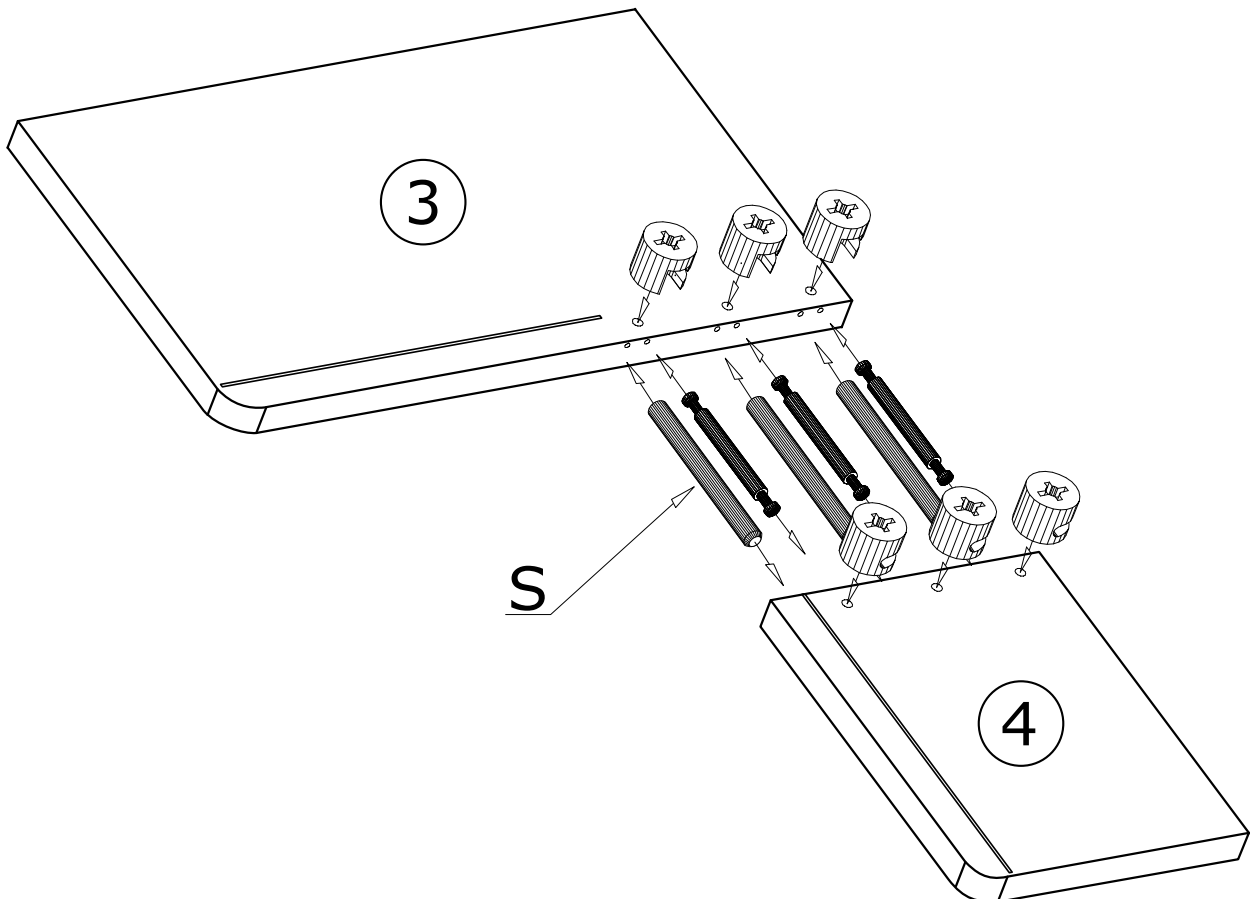

III

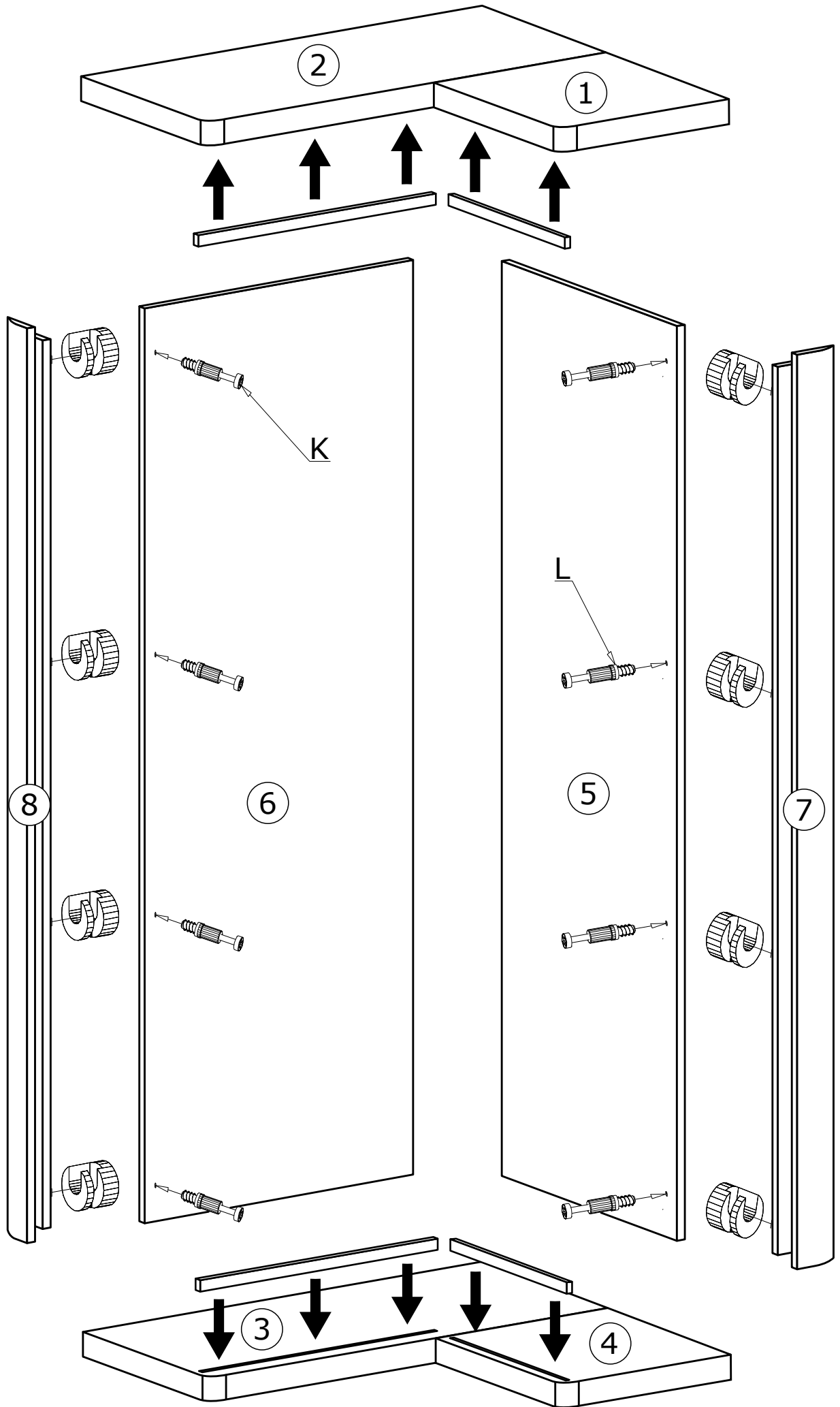

IV

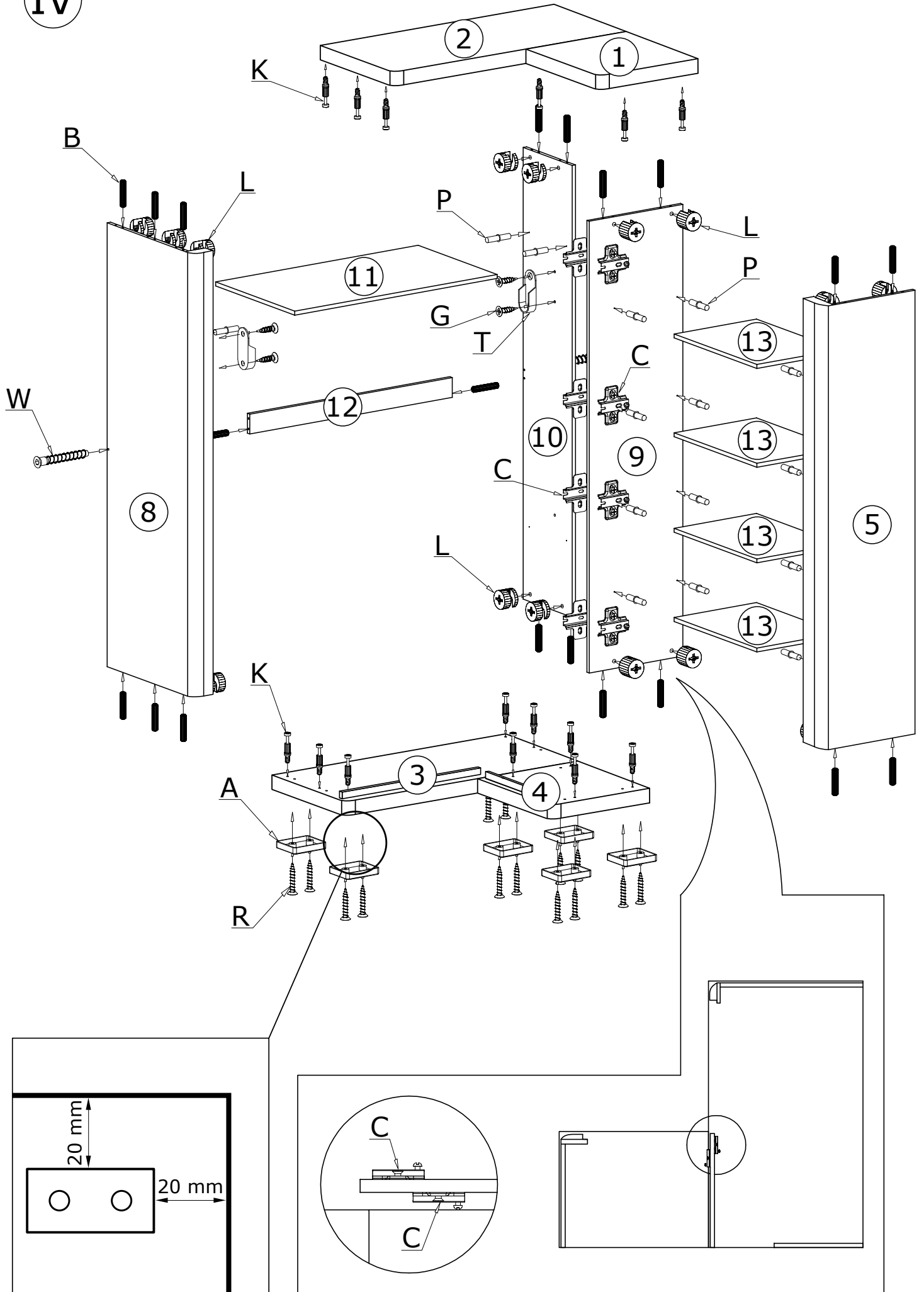

V

100X 

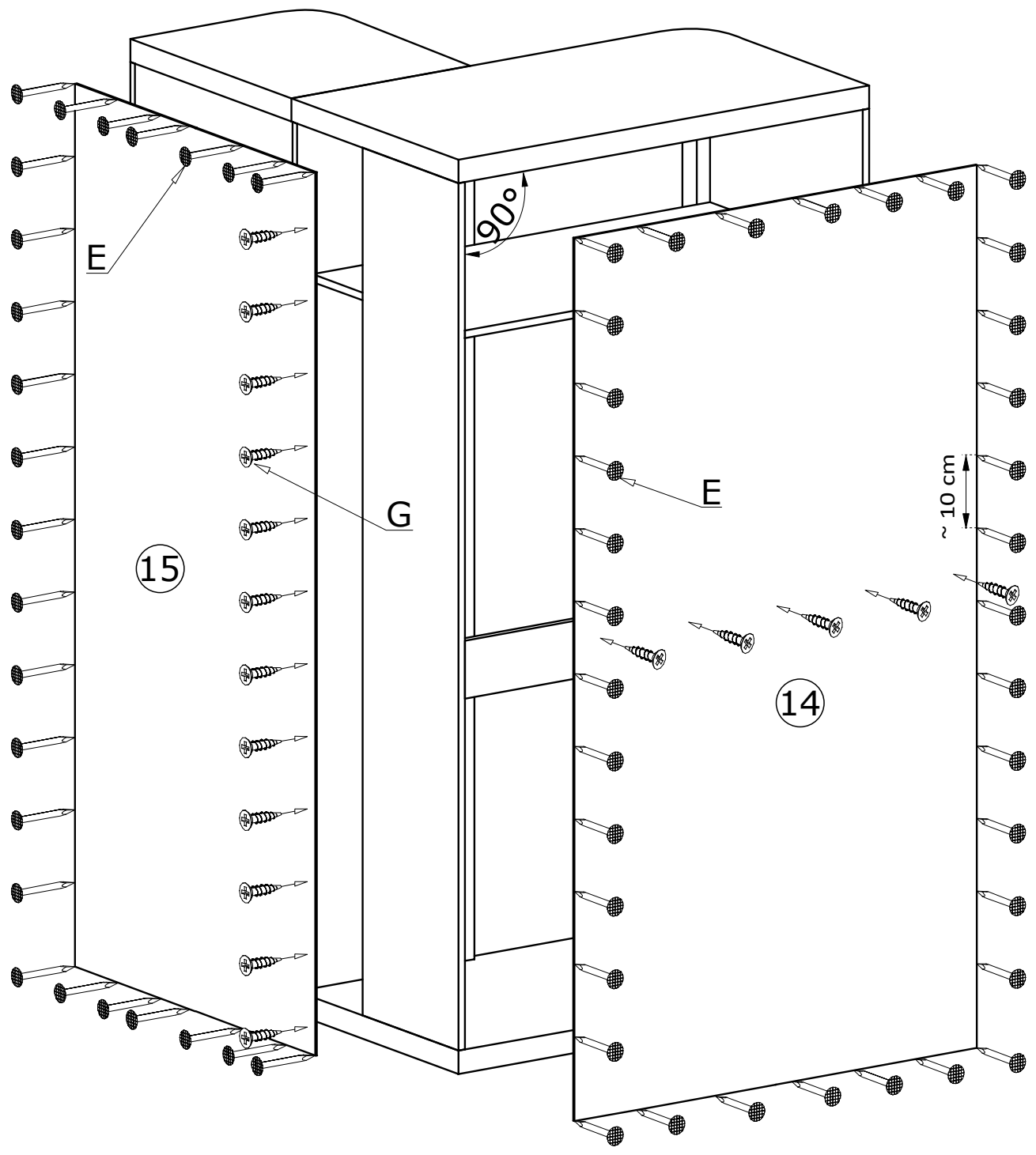

A series of 14 instructional icons labeled A through J:

- A**: Shows a corner of a cabinet with scissors and an upward arrow, indicating where to cut.
- B**: Shows a person walking with a shopping cart, indicating to check the contents of the cart.
- C**: Shows a drill bit and a hole, with the text $\text{Ø}8$, indicating the diameter of the hole.
- D**: Shows two screws being inserted into a hole, indicating the correct orientation.
- E**: Shows a cabinet with a brick wall and a smiley face, indicating that the cabinet should be placed on a solid surface. A checkmark is shown next to the brick wall, and a sad face with a cross is shown next to a cabinet on a soft surface.
- F**: Shows a close-up of a cabinet corner with a pencil and a ruler, indicating the correct placement of the cabinet.
- G**: Shows a close-up of a cabinet corner with a pencil and a ruler, indicating the correct placement of the cabinet.
- H**: Shows a close-up of a cabinet corner with a pencil and a ruler, indicating the correct placement of the cabinet. Dimensions of 480 mm and 275 mm are shown.
- I**: Shows a close-up of a cabinet corner with a pencil and a ruler, indicating the correct placement of the cabinet.
- J**: Shows a close-up of a cabinet corner with a pencil and a ruler, indicating the correct placement of the cabinet.

VI

