

DALLAS 3

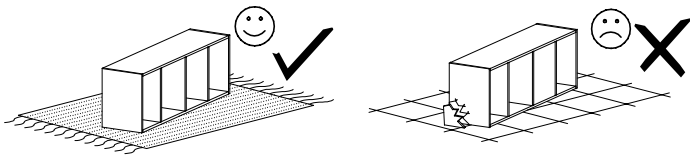

Narzędzia potrzebne do montażu

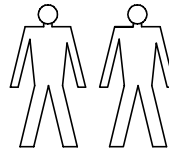
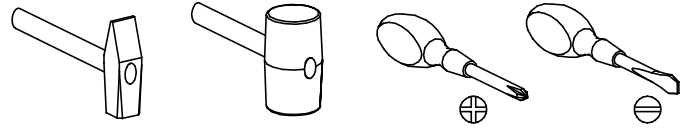

UWAGA !!!

MONTOWANIE USZKODZONYCH
ELEMENTÓW POWODUJE UTRATĘ
GWARANCJI

Nr	D[mm]	S[mm]	G[mm]	Ilość
1	1170	450	48	1
2	1170	450	48	1
3	1130	25	16	2
4	800	422	16	1
5	800	422	16	1
6	800	100	32	1
7	800	100	32	1
8	800	405	16	1
9	833	405	16	1
10	452	380	16	1
11	1160	856	2,5	1
12	594	190	16	4
13	400	150	16	4
14	400	150	16	4
15	518	150	16	4
16	545	405	2,5	4
17	772	550	16	1

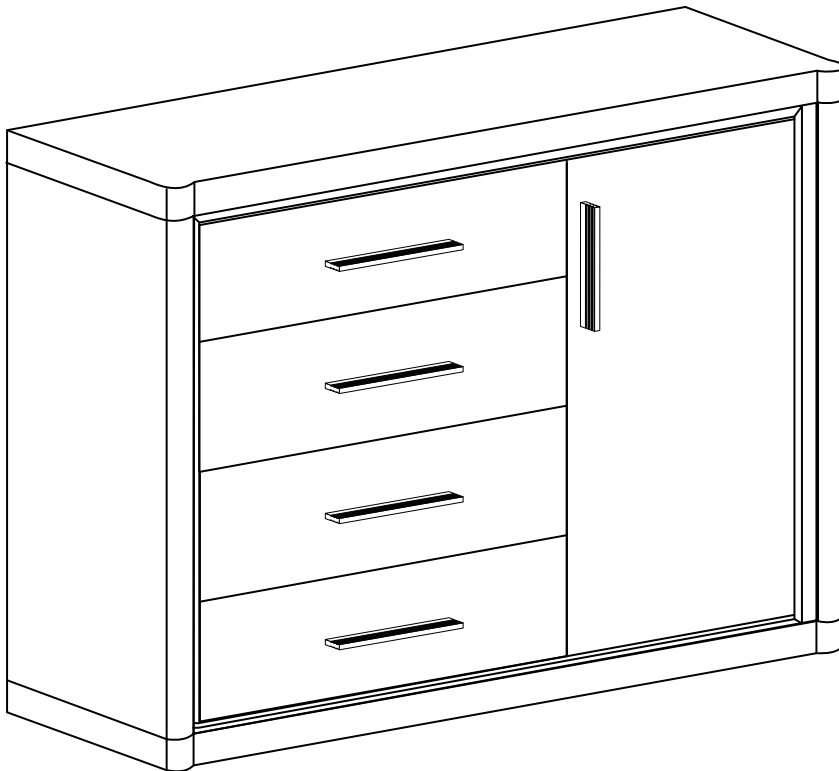

W przypadku reklamacji proszę podać numer pakowacza znajdujący się na kartonie.



X1 - 8 St.

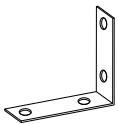

Y - 2 St.

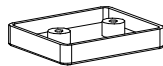

A - 5 St.

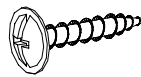

I - 4 St.
3,5x16 mm

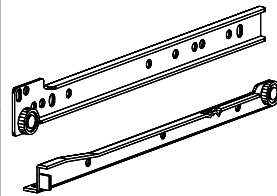

T - 4 Kpl.

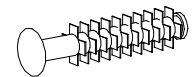

F - 16 St.

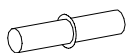

P - 4 St.



N - 10 St.
4x30 mm

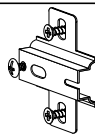

C - 2 St.

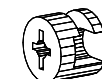

L - 26 St.

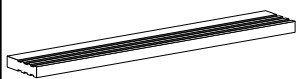

U - 5 St.



G - 4 St.
3,5x16 mm

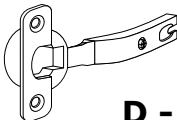

D - 2 St.

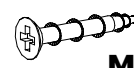

M - 26 St.
4x25 mm



S - 1 St.



E - 70 St.



B - 32 St.

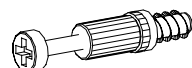

K - 26 St.

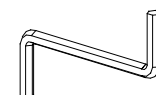

Z - 1 St.



J - 16 St.
5x13 mm

III

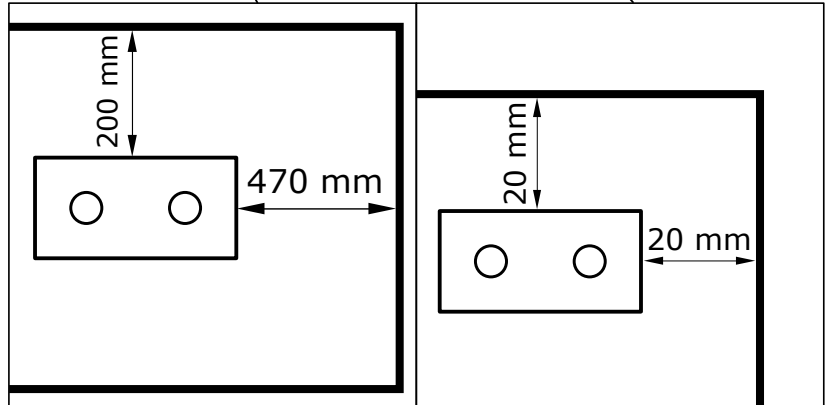
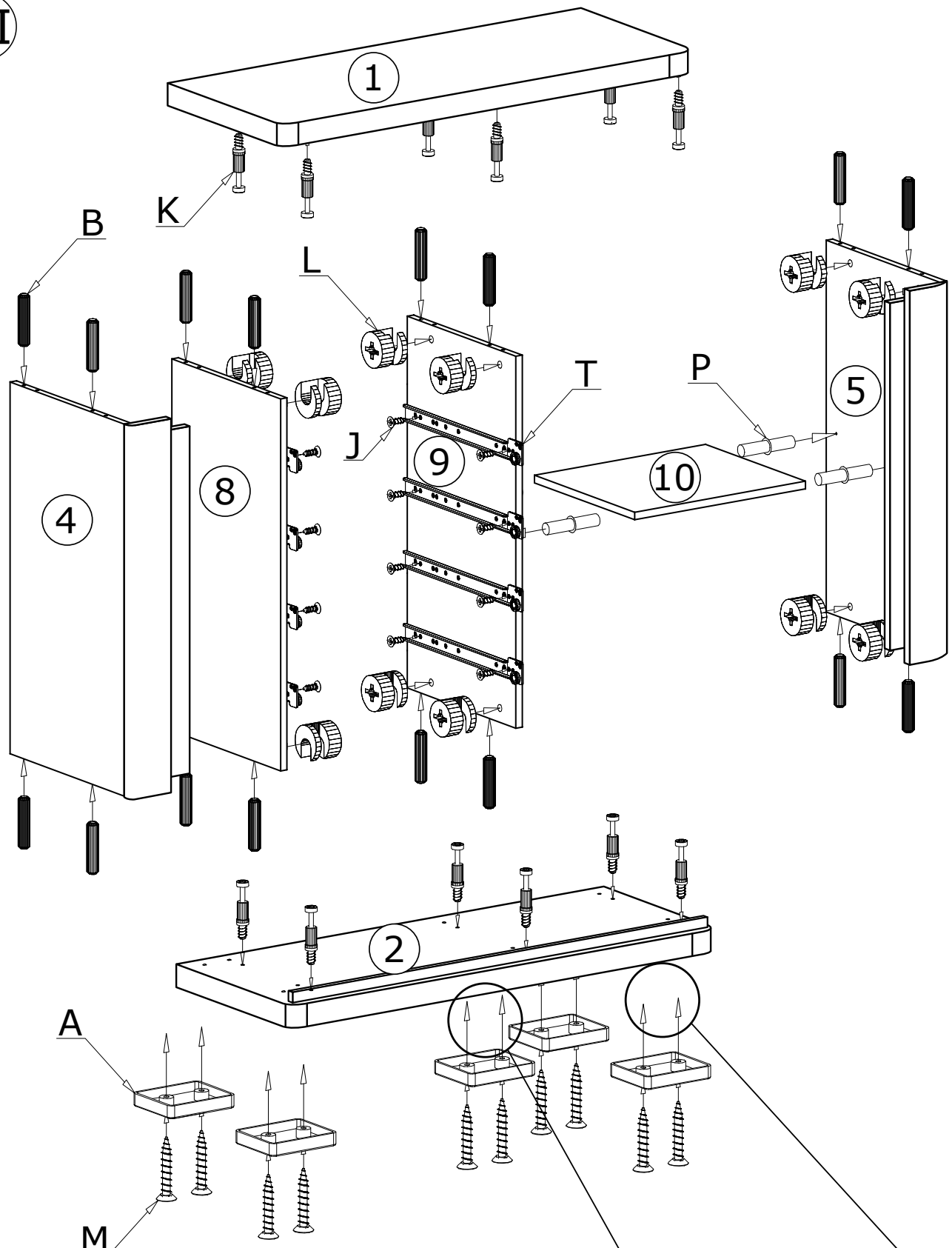

IV

70X 

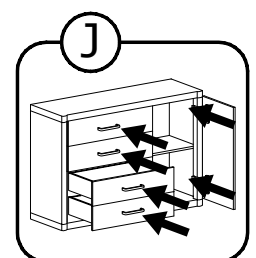
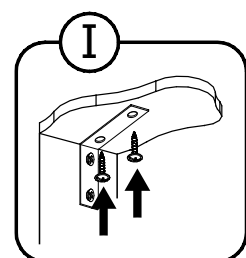
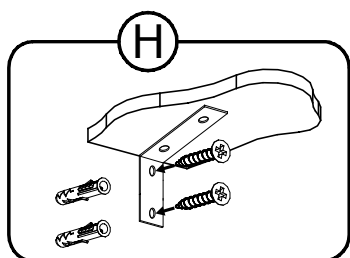
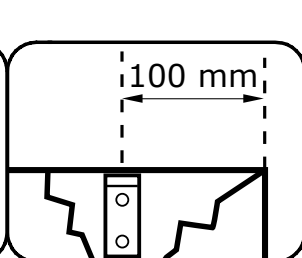
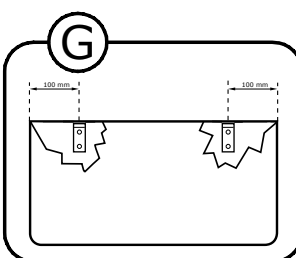
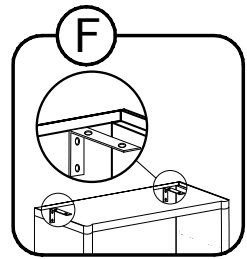
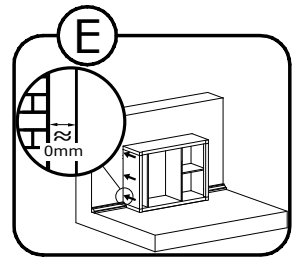
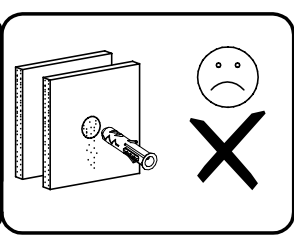
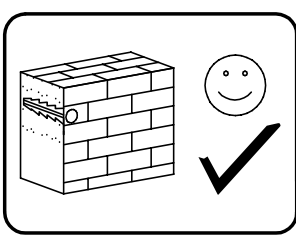
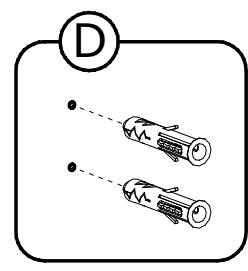
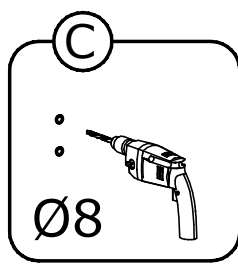
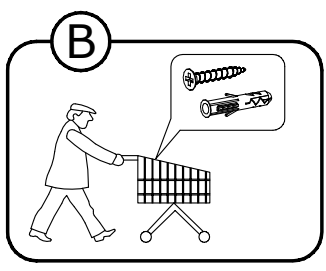
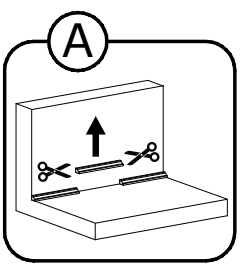
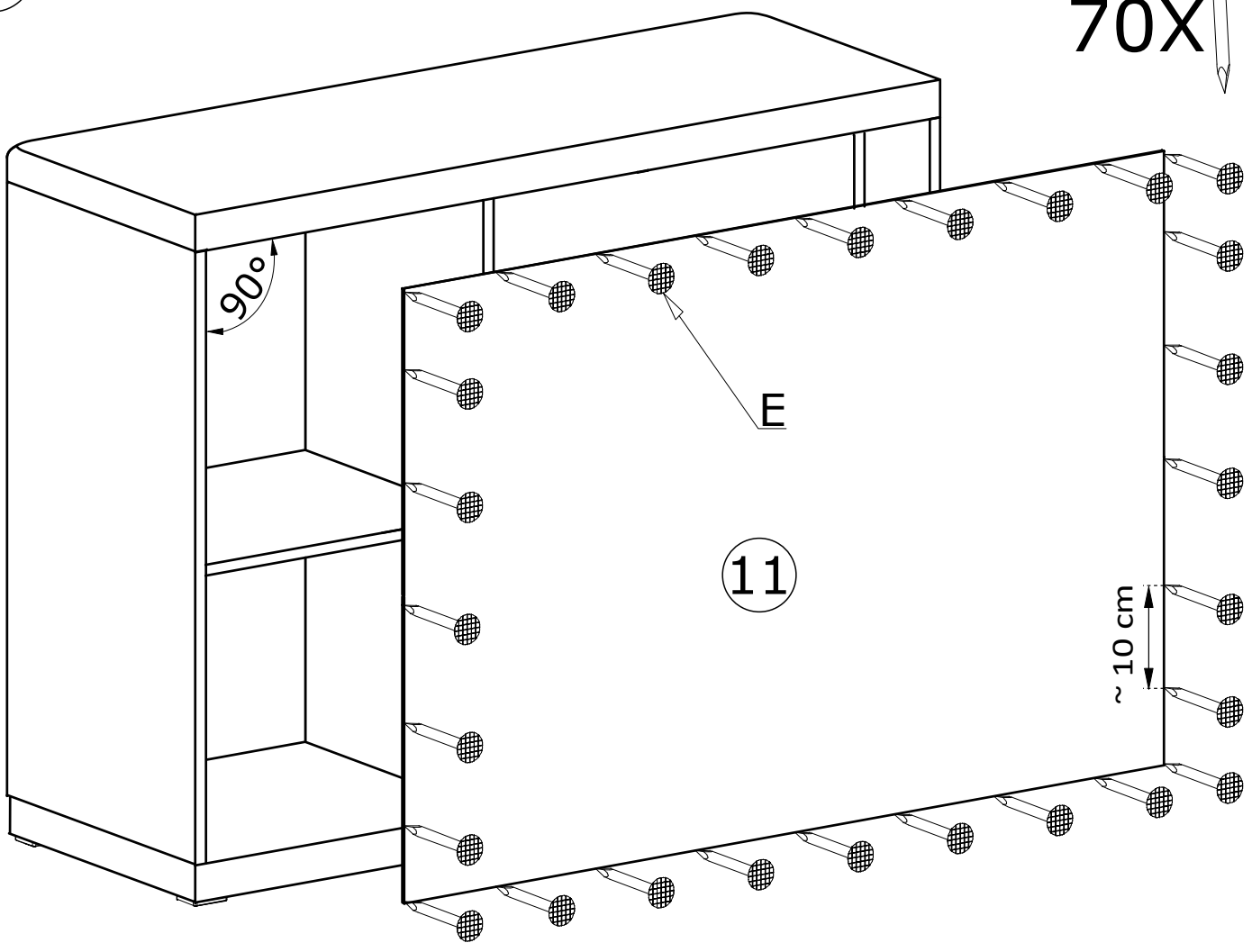

V

