

DALLAS 1

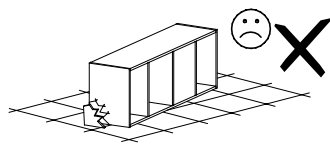

Narzędzia potrzebne do montażu

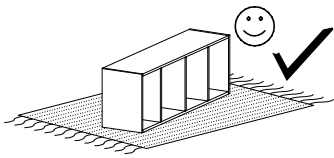
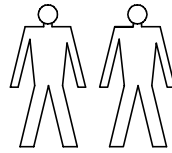
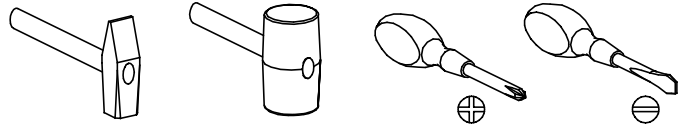

UWAGA !!!

MONTOWANIE USZKODZONYCH
ELEMENTÓW POWODUJE UTRATĘ
GWARANCJI

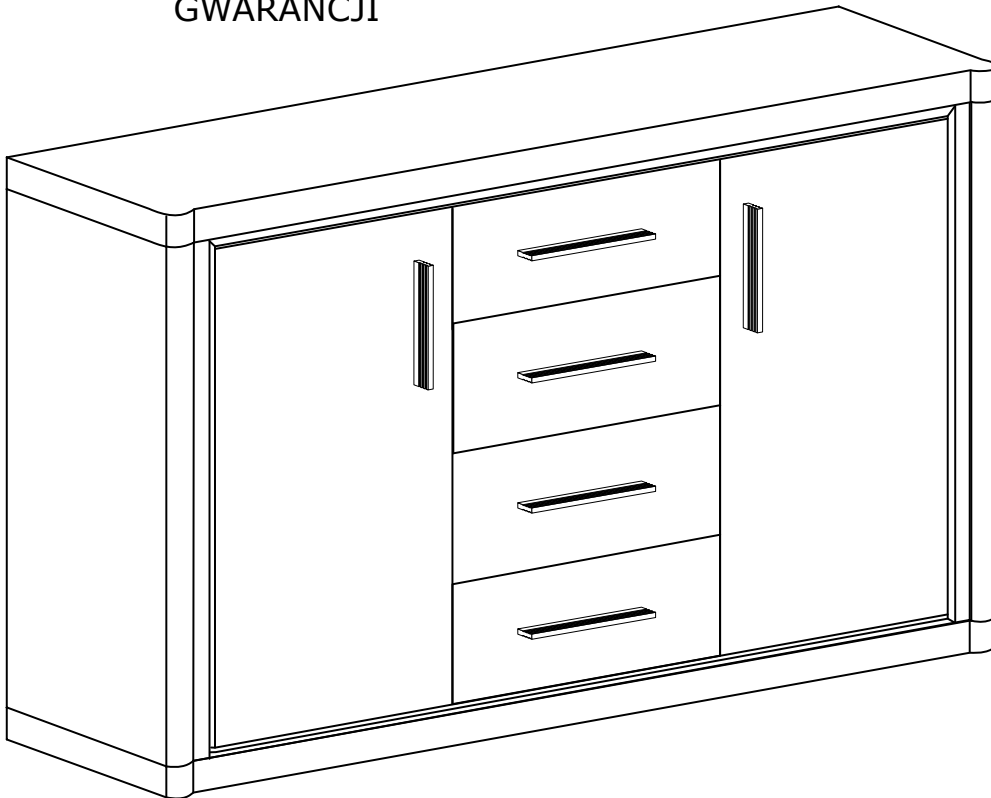

Nr	D[mm]	S[mm]	G[mm]	Ilość
1	1570	450	48	1
2	1570	450	48	1
3	1530	25	16	2
4	800	422	16	1
5	800	422	16	1
6	800	100	32	1
7	800	100	32	1
8	835	405	16	1
9	835	405	16	1
10	440	380	16	2
11	1560	856	2,5	1
12	636	190	16	4
13	400	150	16	4
14	400	150	16	4
15	560	150	16	4
16	590	405	2,5	4
17	772	365	16	1
18	772	365	16	1

W przypadku reklamacji proszę podać numer pakowacza znajdujący się na kartonie.

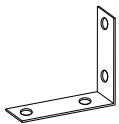

Y - 2 St.

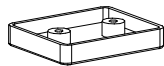

A - 6 St.



M - 28 St.
4x25 mm

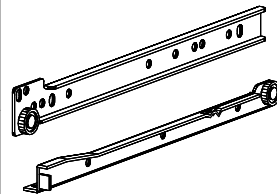

T - 4 Kpl.

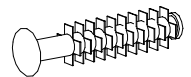

F - 16 St.

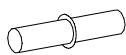

P - 8 St.



N - 12 St.
4x30 mm

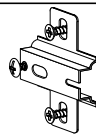

C - 4 St.



L - 22 St.

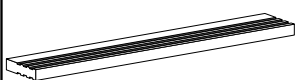

U - 6 St.



G - 8 St.
3,5x16 mm

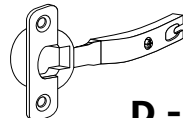

D - 4 St.



I - 4 St.
3,5x16 mm



S - 1 St.



E - 90 St.



B - 32 St.

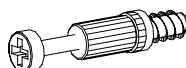

K - 22 St.

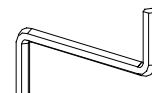

Z - 1 St.



J - 16 St.
5x13 mm

I

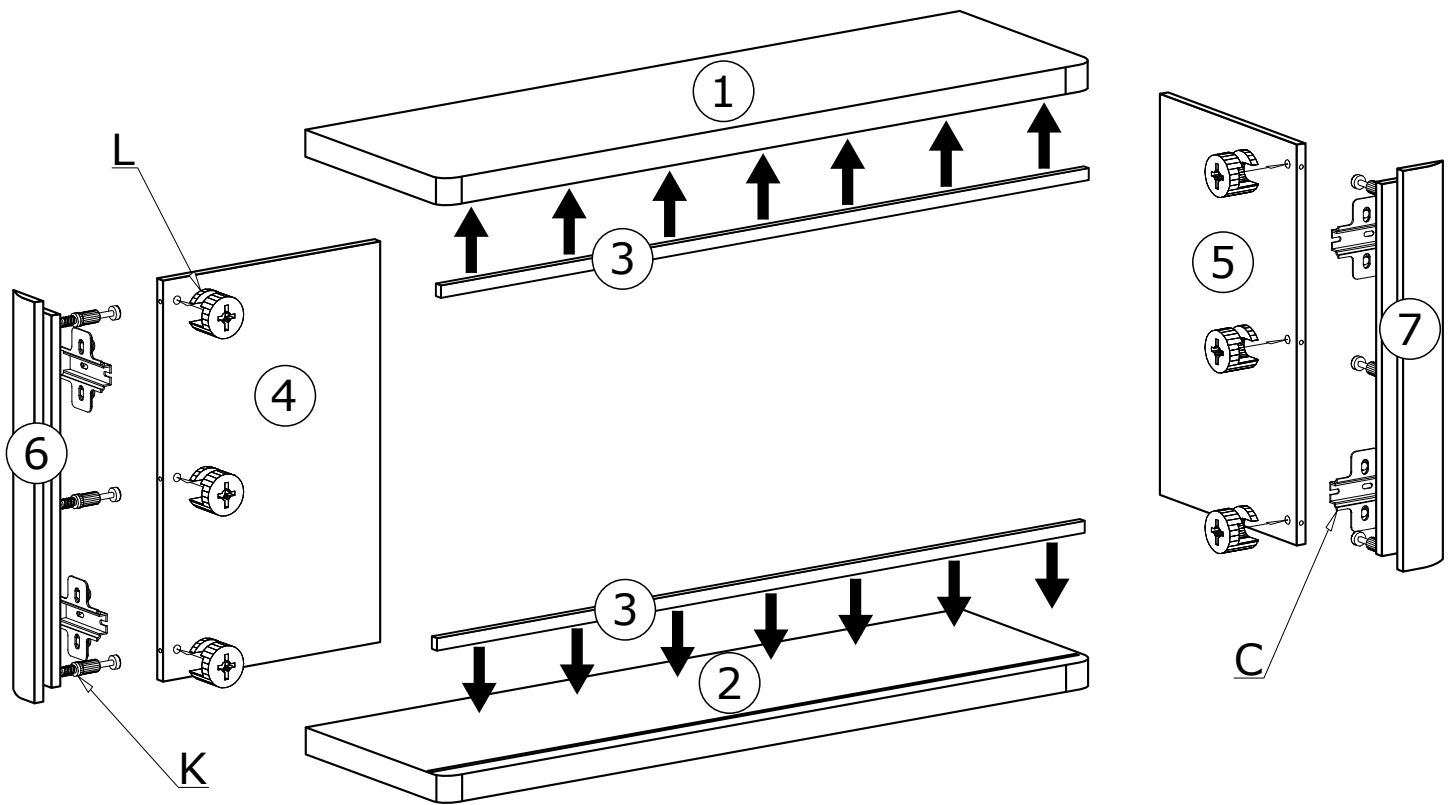

II

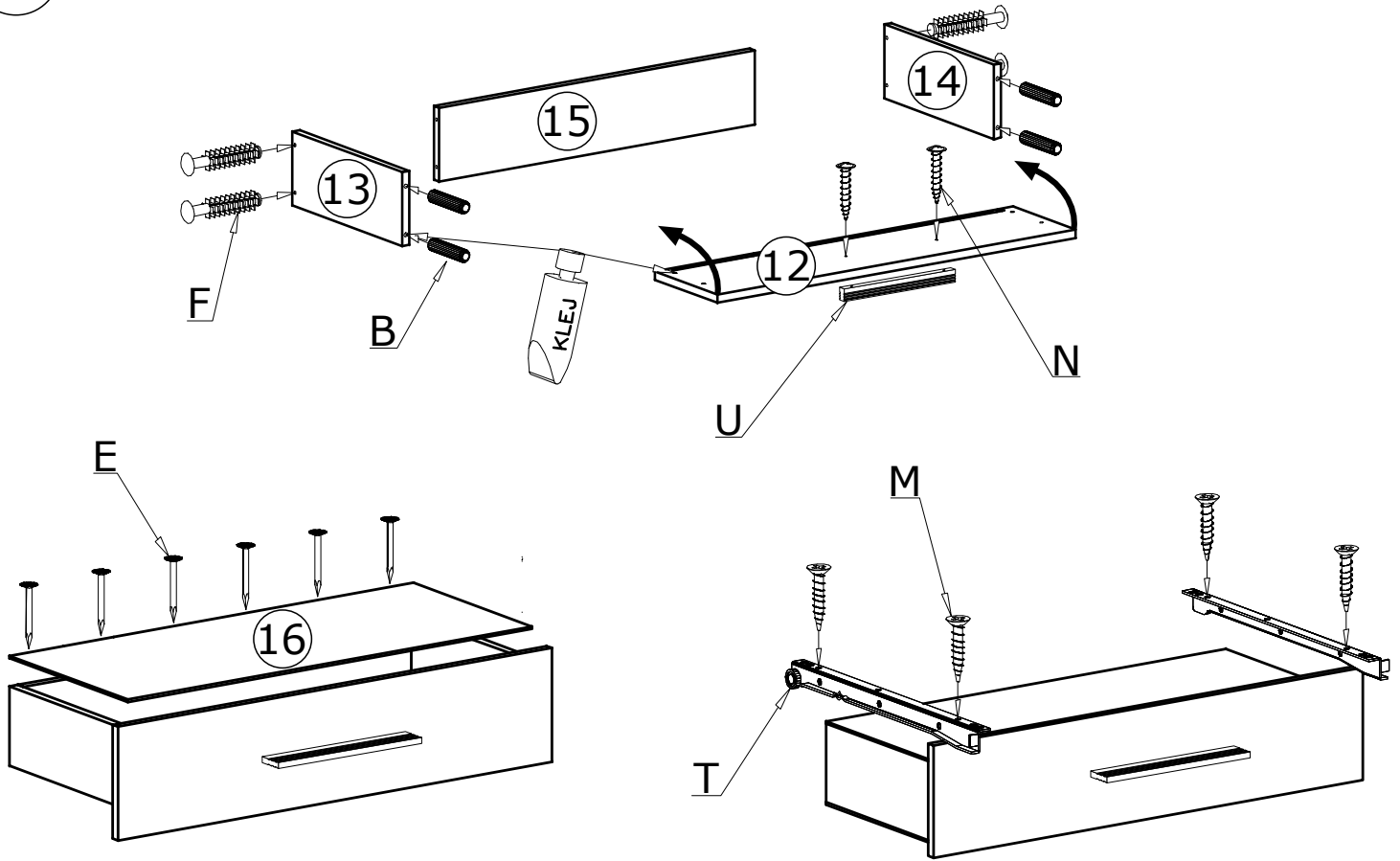

III

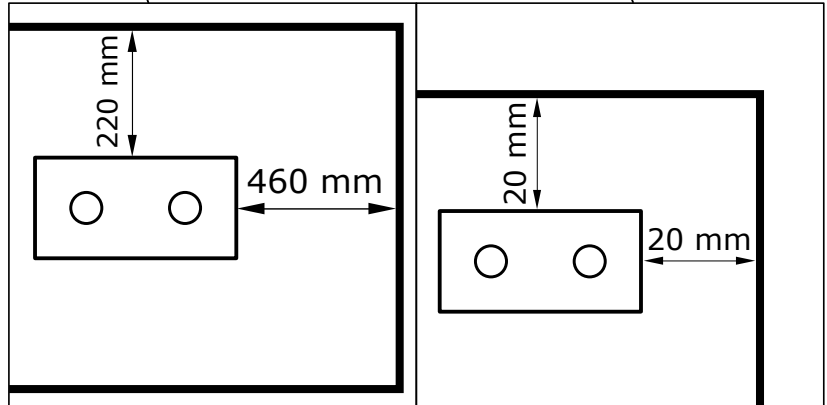
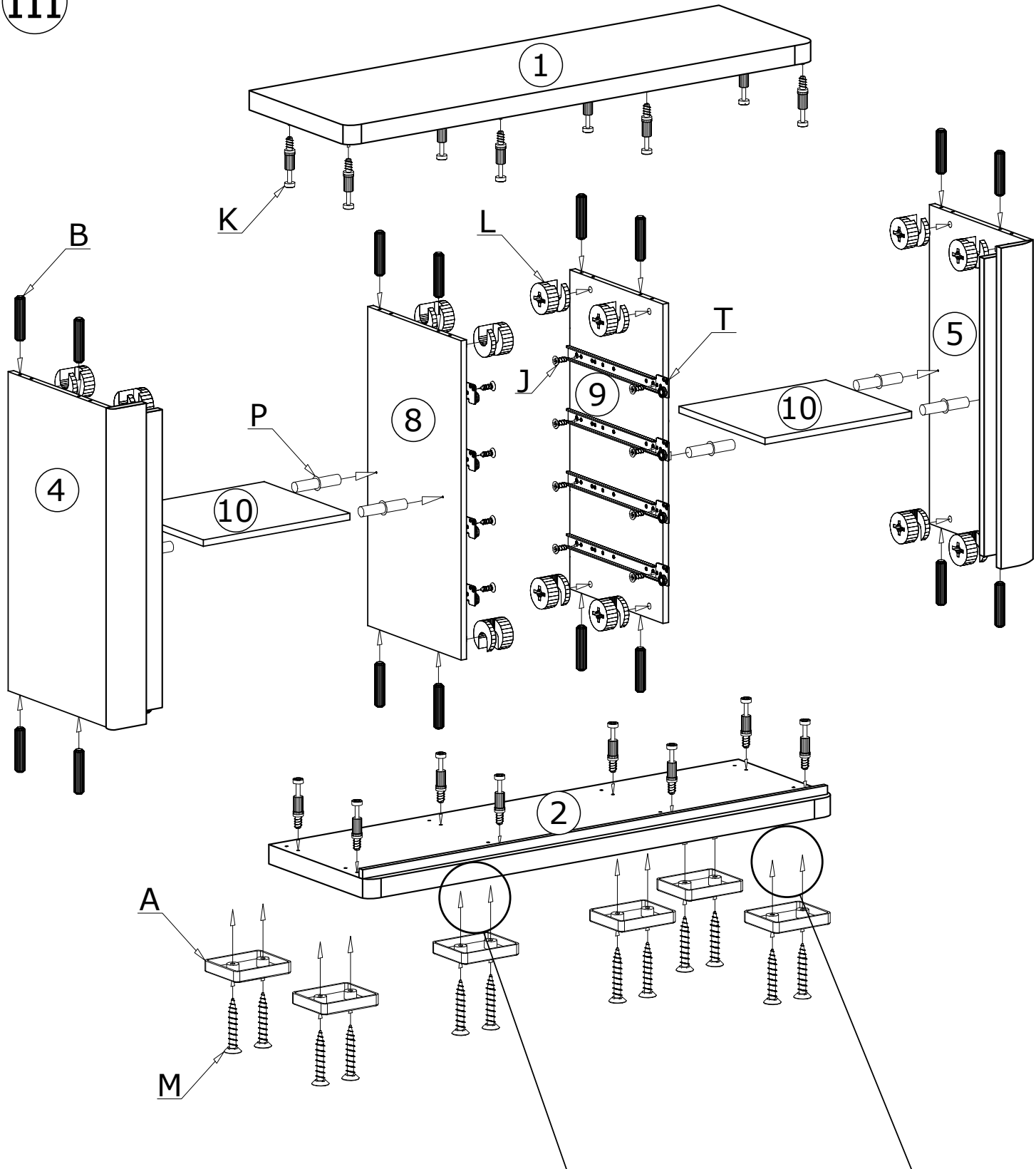

IV

70X 

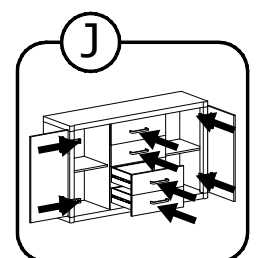
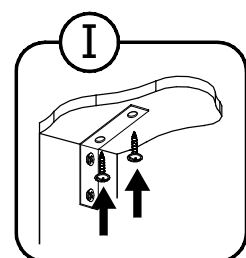
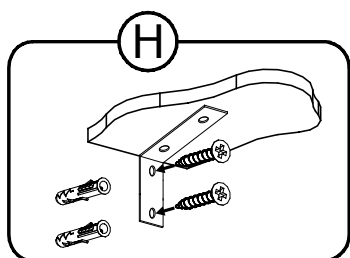
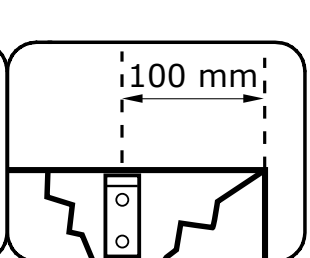
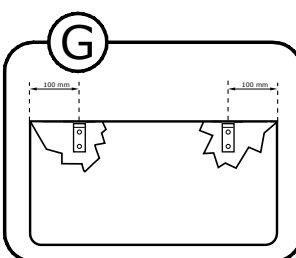
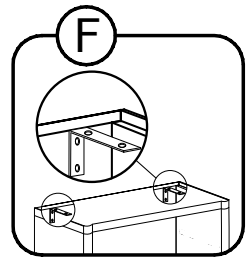
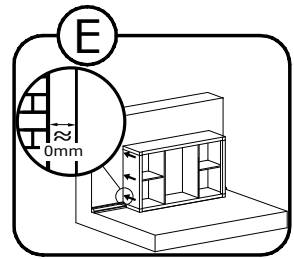
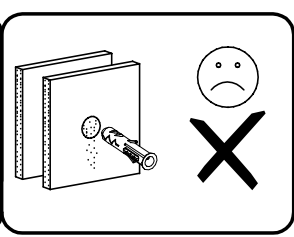
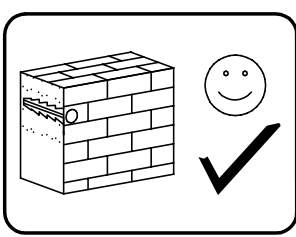
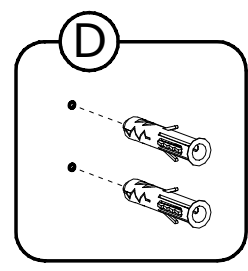
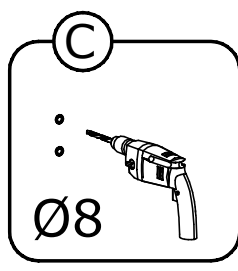
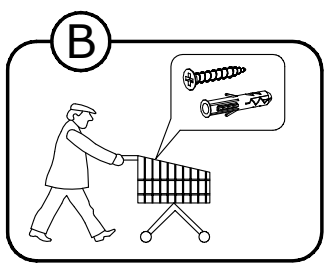
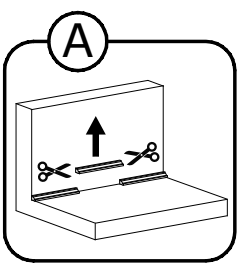
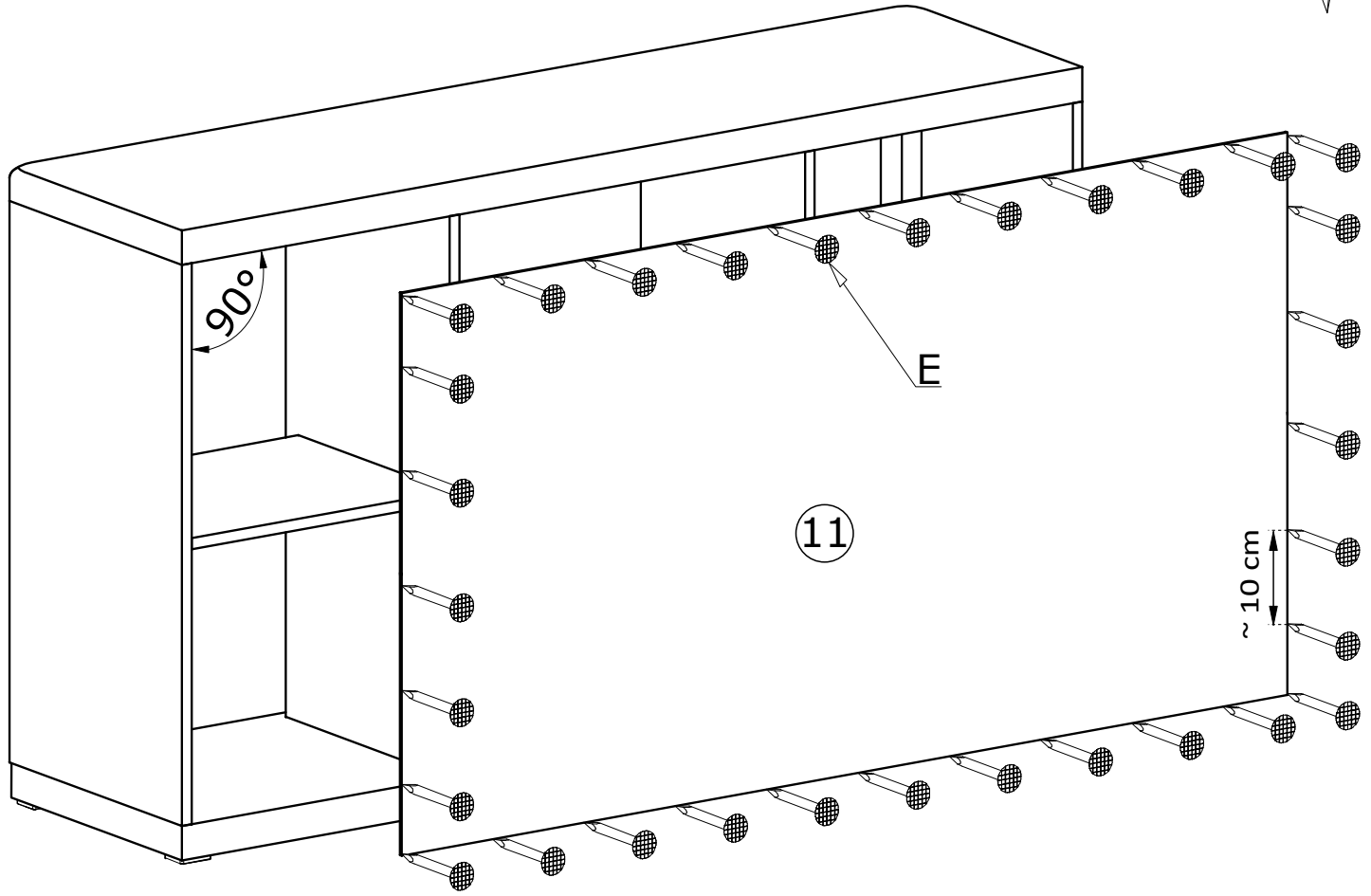

V

