

# BELLO 10



Narzędzia potrzebne do montażu



## **UWAGA !!!**

MONTOWANIE USZKODZONYCH  
ELEMENTÓW POWODUJE UTRATĘ  
GWARANCJI

Nr	D[mm]	S[mm]	G[mm]	Ilość
1	1592	405	16	1
2	1592	405	16	1
3	400	405	16	1
4	400	405	16	1
5	400	405	16	1
6	400	405	16	1
7	1583	424	2,5	1
8	373	380	16	2
9	430	402	16	1
10	430	402	16	1
11	780	380	16	1

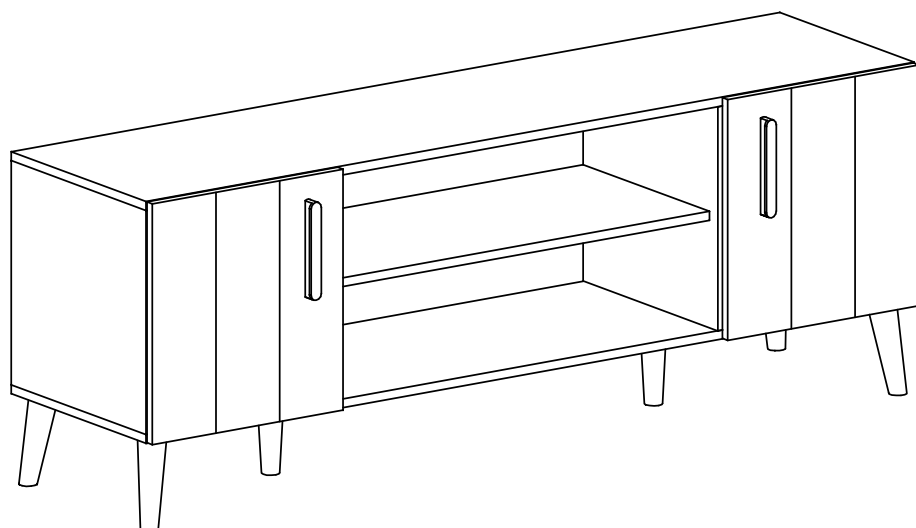

## **UWAGA !!!**

Mebel zawiera  
elementy drewniane

W przypadku reklamacji proszę podać numer pakowacza znajdujący się na kartonie.



**S - 2 St.**

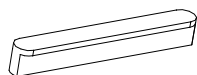

**U - 2 St.**

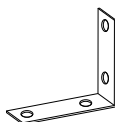

**I - 2 St.**

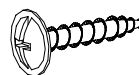

**Q - 4 St.**  
3,5X16 mm



**P1 - 4 St.**



**P2 - 2 St.**



**F - 12 St.**



**N - 4 St.**  
3,5x25 mm

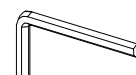

**Z - 1 St.**

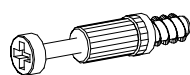

**K - 16 St.**



**L - 16 St.**



**C2 - 2 St.**

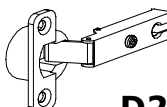

**D2 - 2 St.**



**B - 16 St.**



**E - 45 St.**

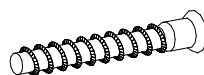

**A - 8 St.**

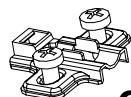

**C1 - 2 St.**

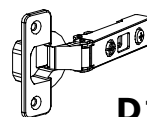

**D1 - 2 St.**

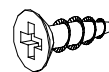

**G - 8 St.**  
3,5x16 mm

I

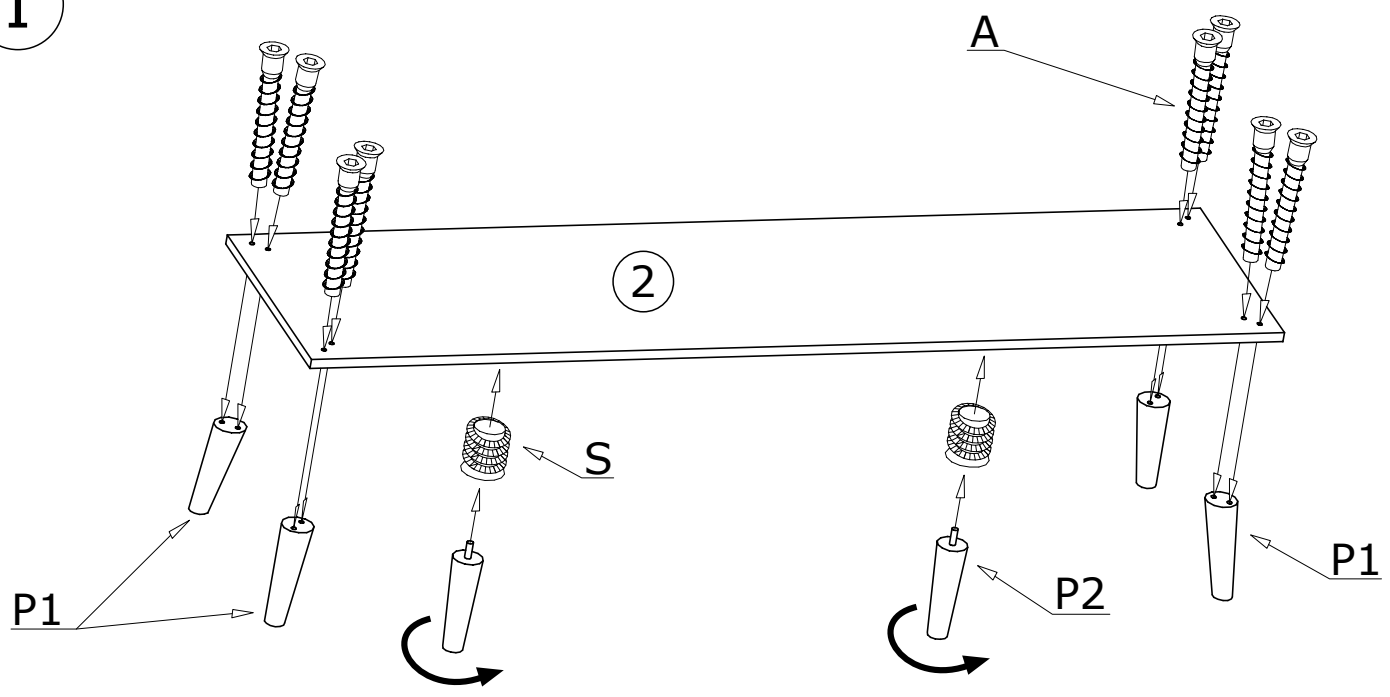

II

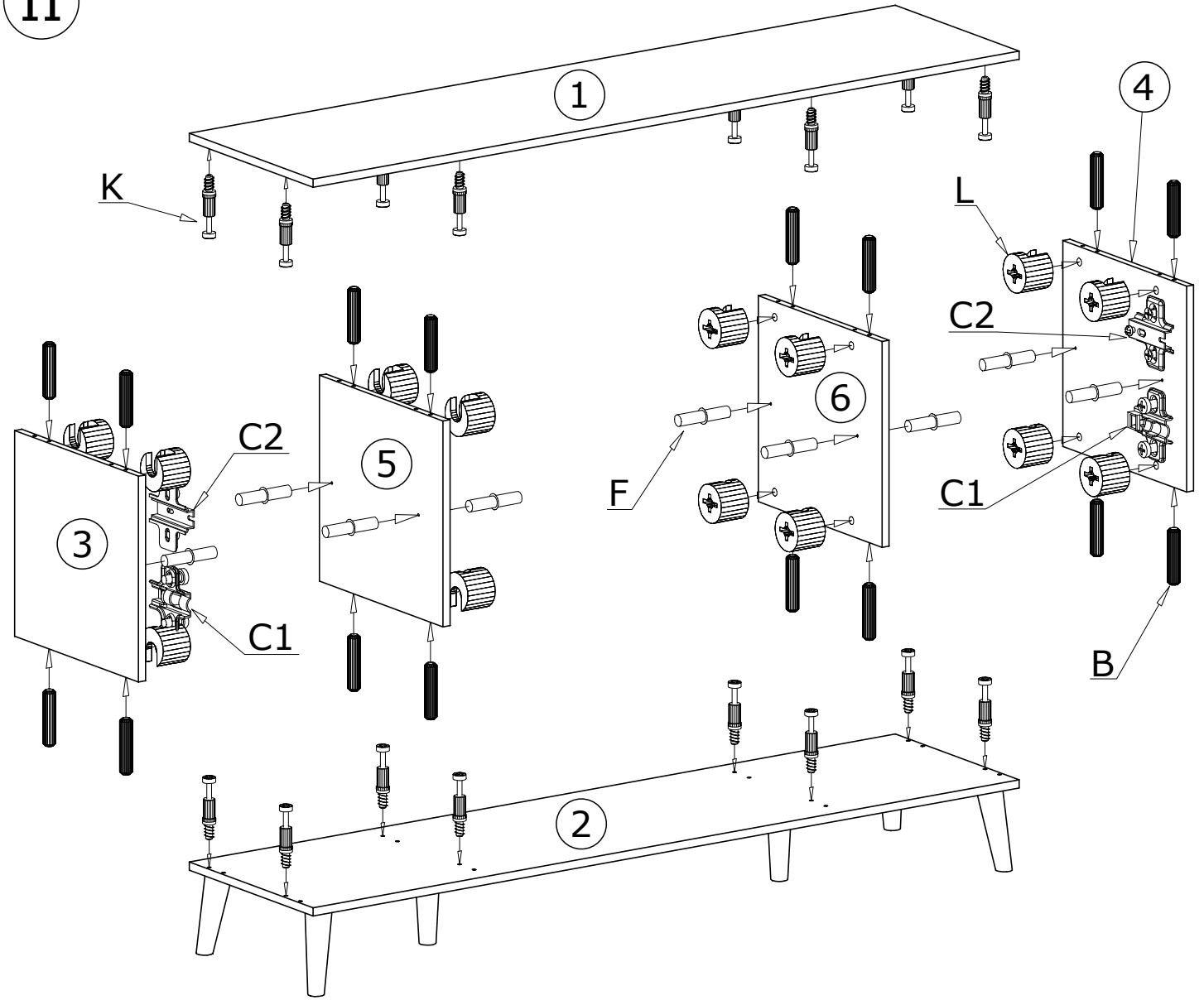

III

45X 

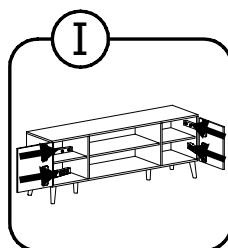
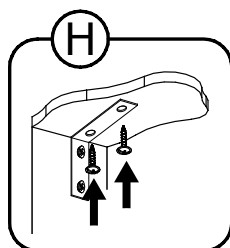
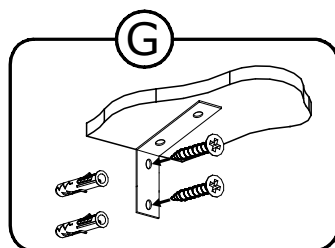
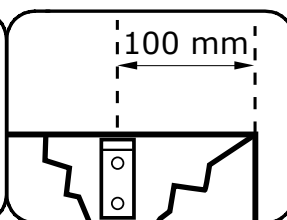
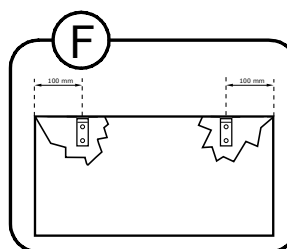
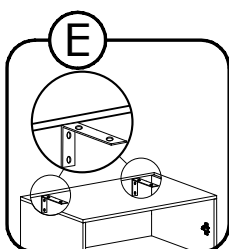
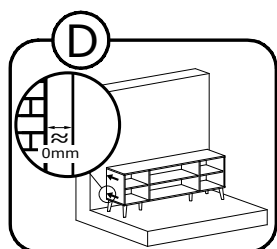
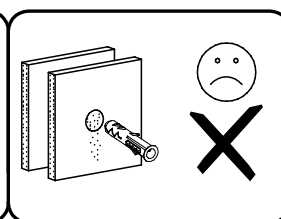
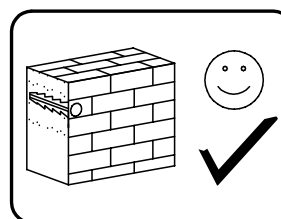
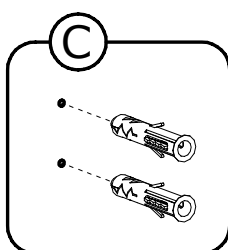
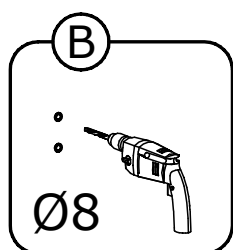
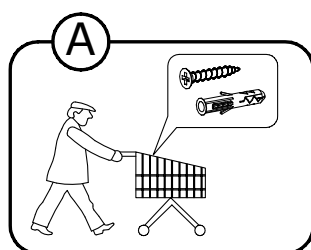
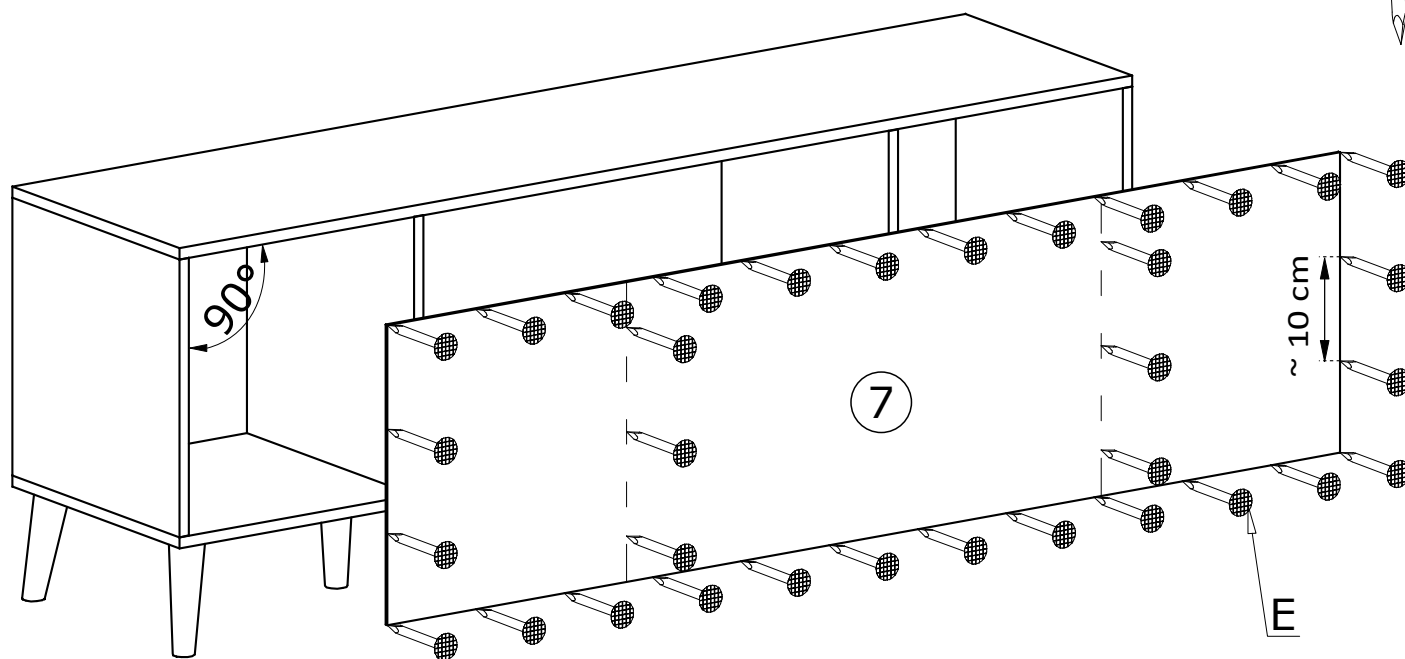

Meble zawierają elementy drewniane, których barwa i układ słoju są uzależnione od wielu czynników, dlatego mogą występować różnice w fakturze i barwie co nie stanowi wady produktu i nie wpływa na jego jakość, trwałość i funkcjonalność.

Elementy drewniane mogą ujawniać niewielkie zmiany w kształcie i wymiarach wywołane specyficznymi warunkami eksploatacji takimi jak: wilgotność, różnice temperatur, etc.

IV

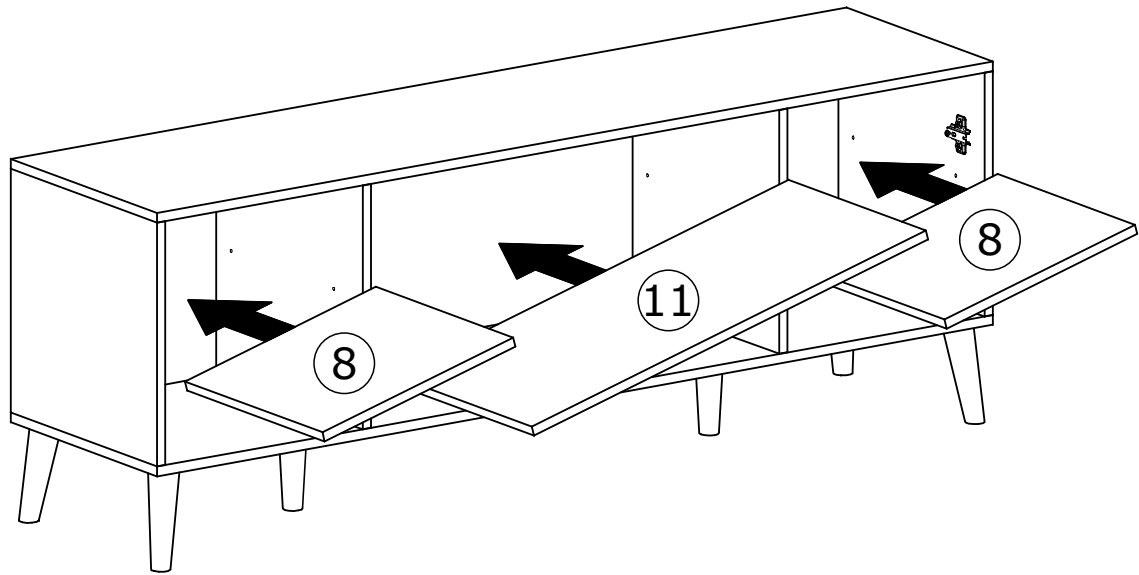

V

