

# BELLO 9

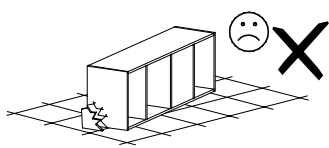

Narzędzia potrzebne do montażu

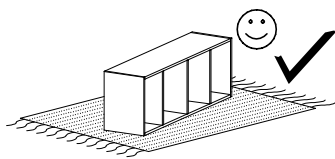

## UWAGA !!!

MONTOWANIE USZKODZONYCH  
ELEMENTÓW POWODUJE UTRATĘ  
GWARANCJI

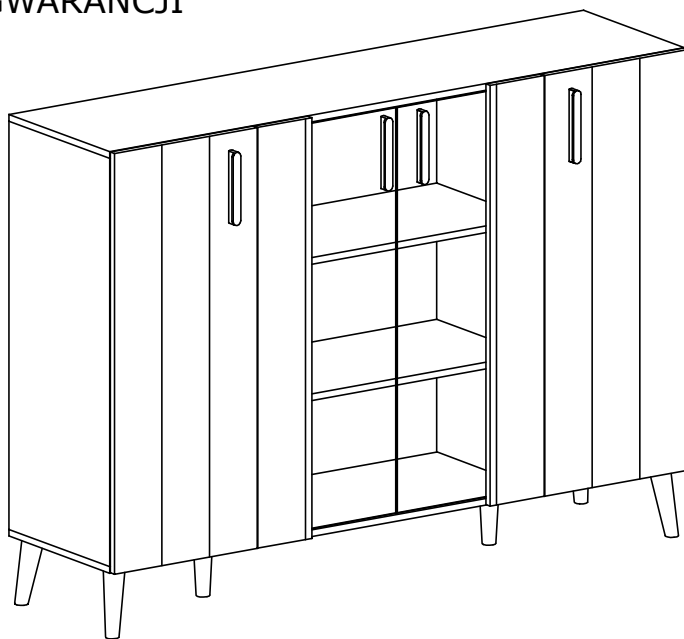

Nr	D[mm]	S[mm]	G[mm]	Ilość
1	1622	405	16	1
2	1622	405	16	1
3	975	405	16	1
4	975	405	16	1
5	975	405	16	1
6	975	405	16	1
7	968	290	4	2
8	1005	152	16	2
9	1005	402	16	1
10	1005	402	16	1
11	793	380	16	2
12	382	380	16	4
13	998	402	2,5	2
14	998	800	2,5	1

## UWAGA !!!

Mebel zawiera  
elementy drewniane

W przypadku reklamacji proszę podać numer pakowacza znajdujący się na kartonie.



**R - 10 St.**



**X - 4 St.**  
3,5x20 mm

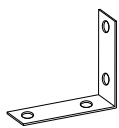

**I - 2 St.**

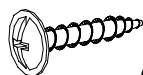

**Q - 4 St.**  
3,5x16 mm

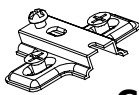

**C4 - 2 St.**

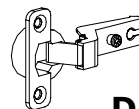

**D4 - 2 St.**



**S - 2 St.**



**P1 - 4 St.**



**P2 - 2 St.**



**C3 - 2 St.**

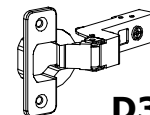

**D3 - 2 St.**

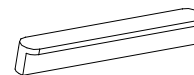

**U - 4 St.**

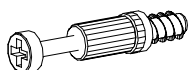

**K - 16 St.**



**L - 16 St.**



**J - 14 St.**



**N - 4 St.**  
3,5x25 mm

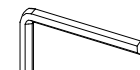

**Z - 1 St.**



**E - 80 St.**

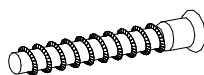

**A - 8 St.**

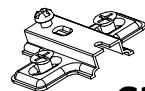

**C2 - 2 St.**

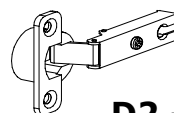

**D2 - 2 St.**

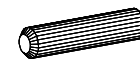

**B - 16 St.**



**Y - 1 St.**

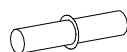

**F - 24 St.**



**C1 - 2 St.**

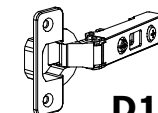

**D1 - 2 St.**

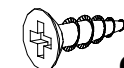

**G - 22 St.**  
3,5x16 mm

I

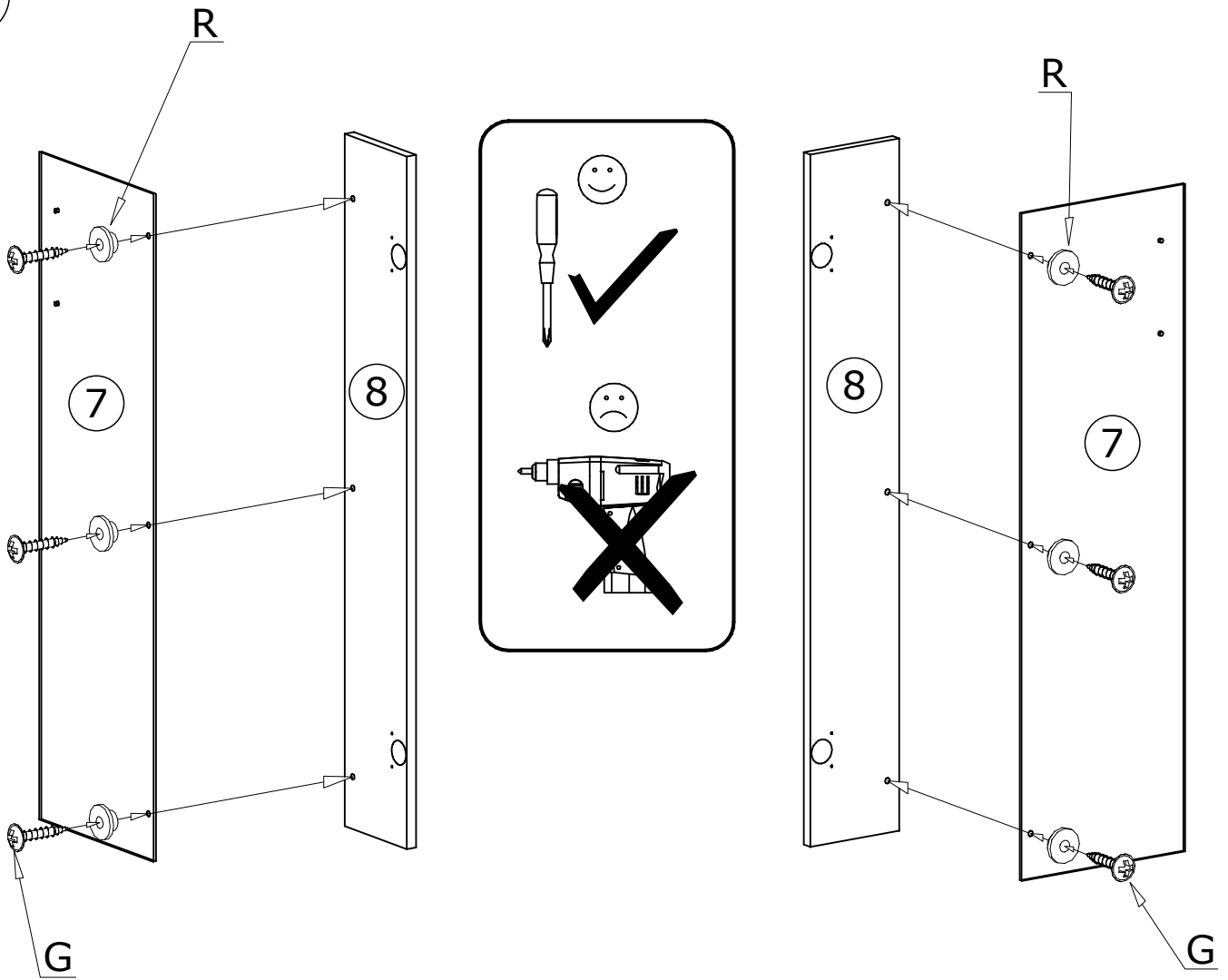

II

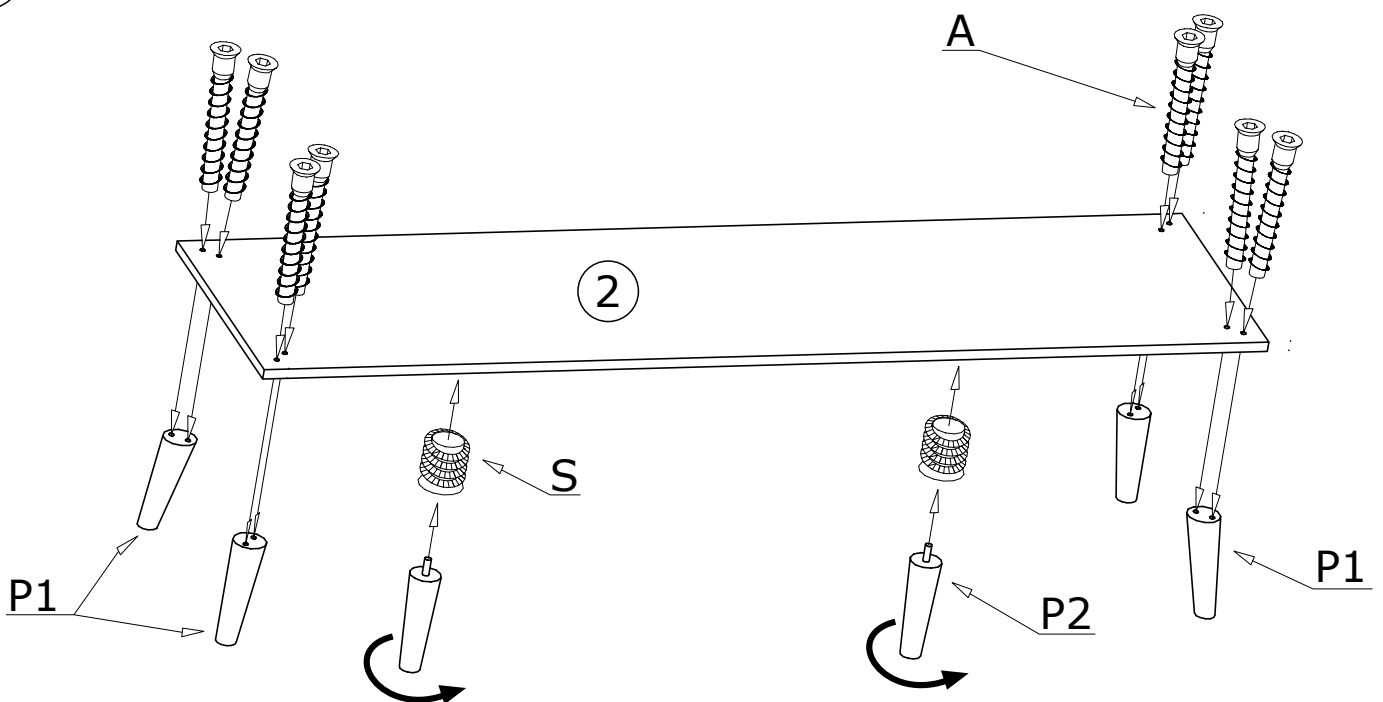

III

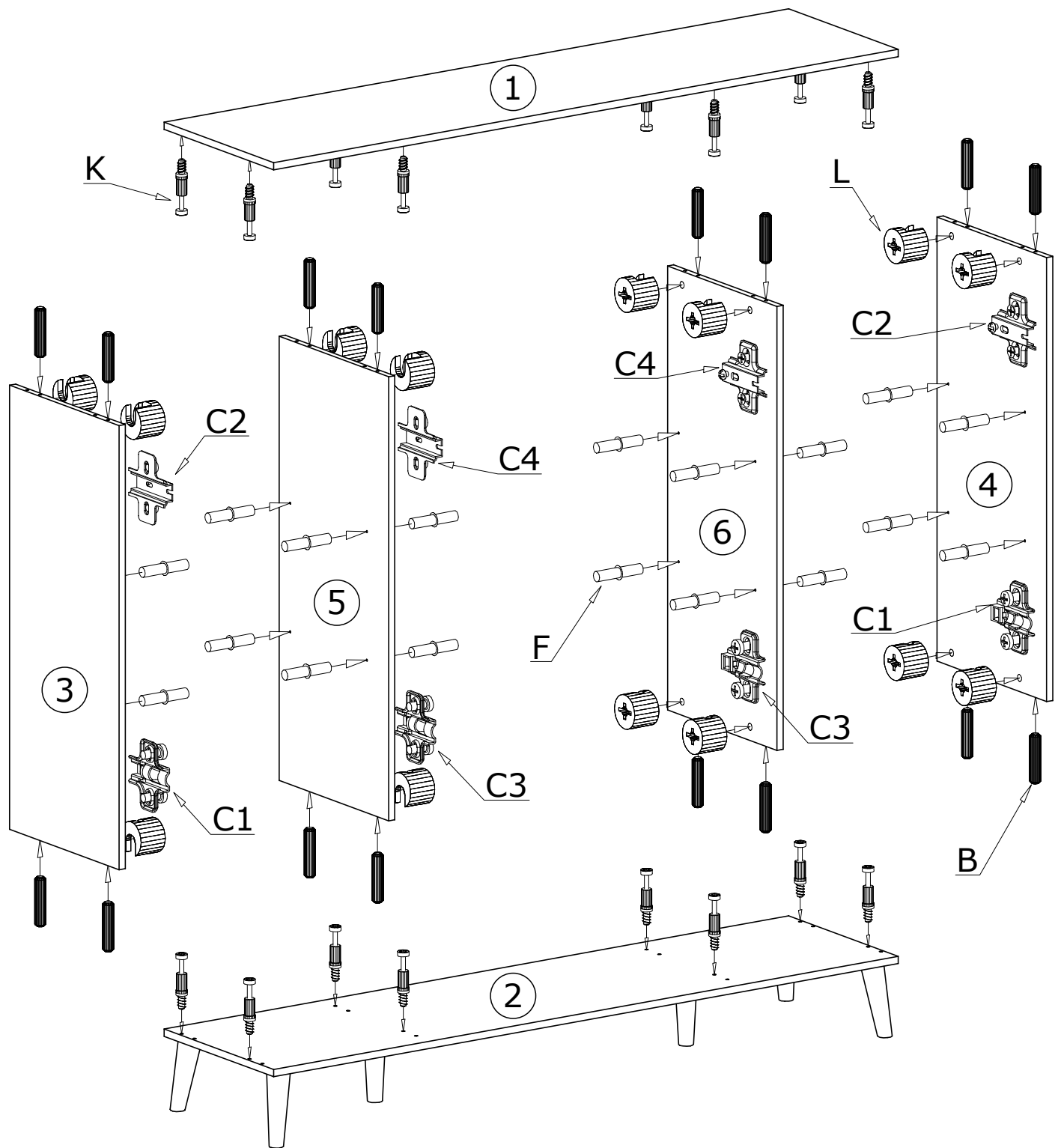

Meble zawierają elementy drewniane, których barwa i układ słojów są uzależnione od wielu czynników, dlatego mogą występować różnice w fakturze i barwie co nie stanowi wady produktu i nie wpływa na jego jakość, trwałość i funkcjonalność.

Elementy drewniane mogą ujawniać niewielkie zmiany w kształcie i wymiarach wywołane specyficznymi warunkami eksploatacji takimi jak: wilgotność, różnice temperatur, etc.

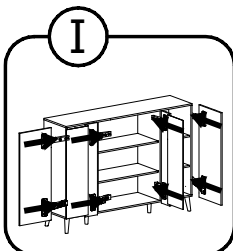
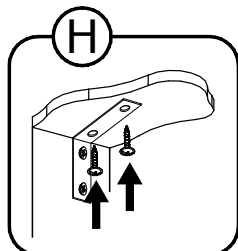
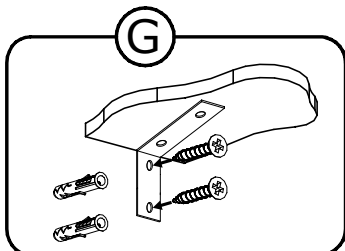
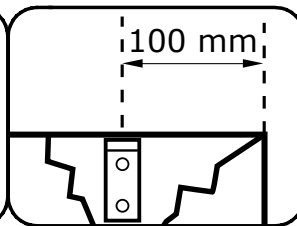
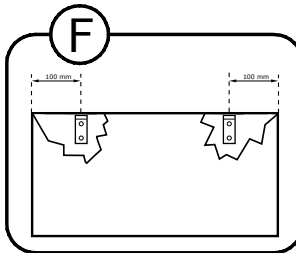
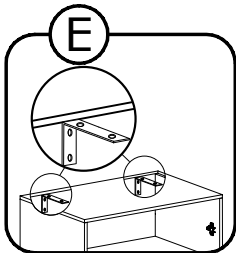
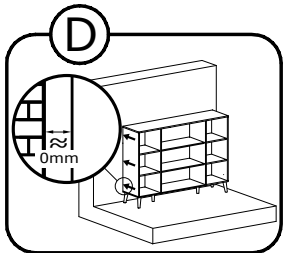
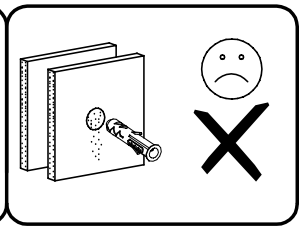
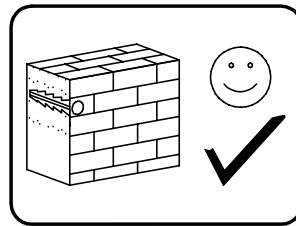
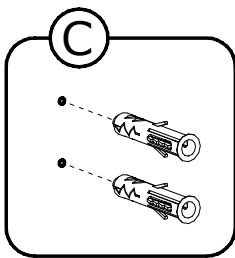
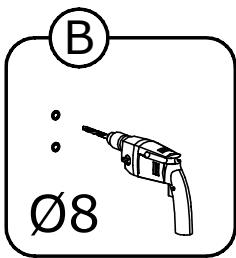
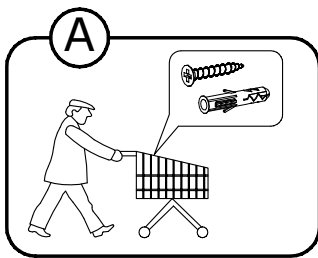
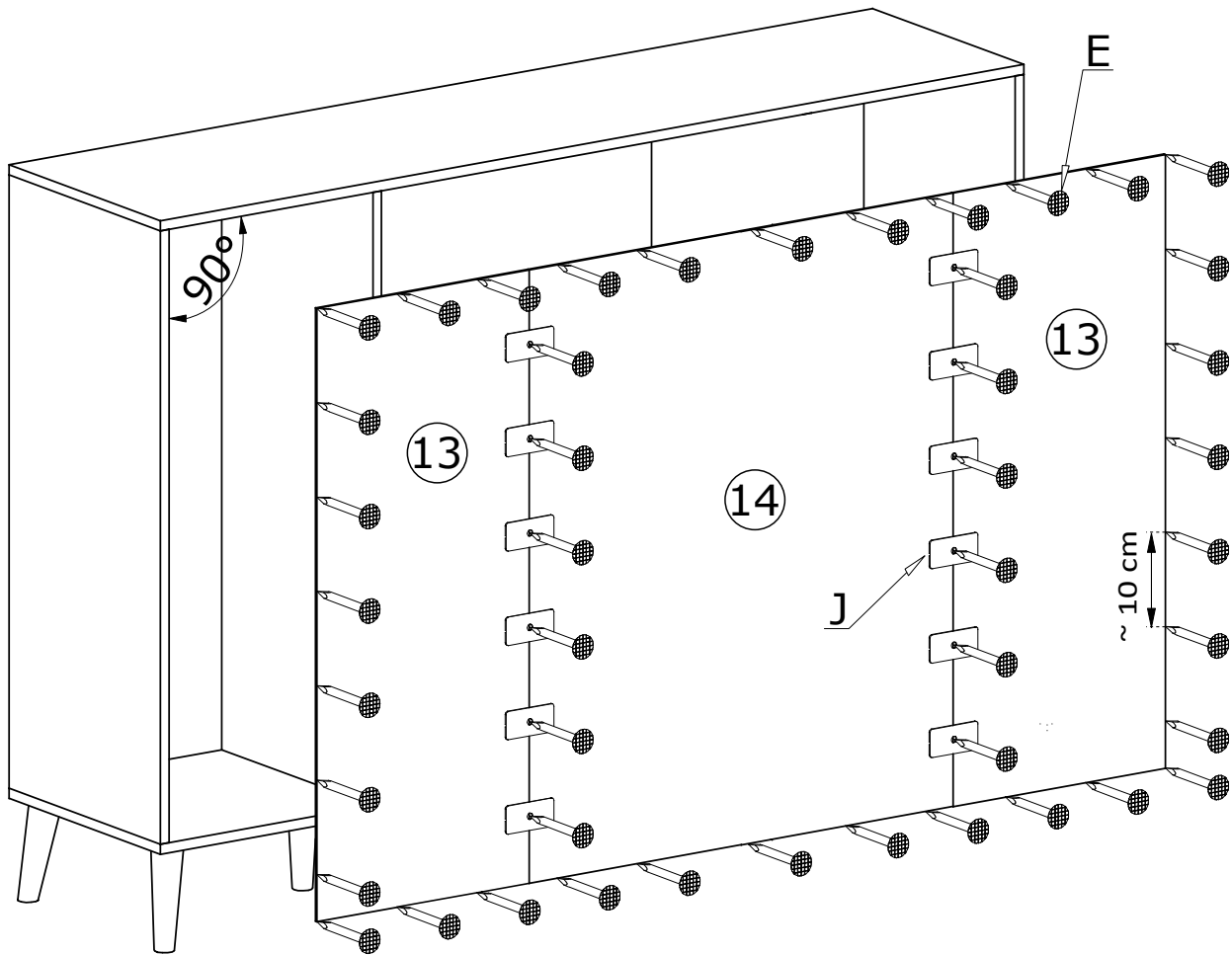

V

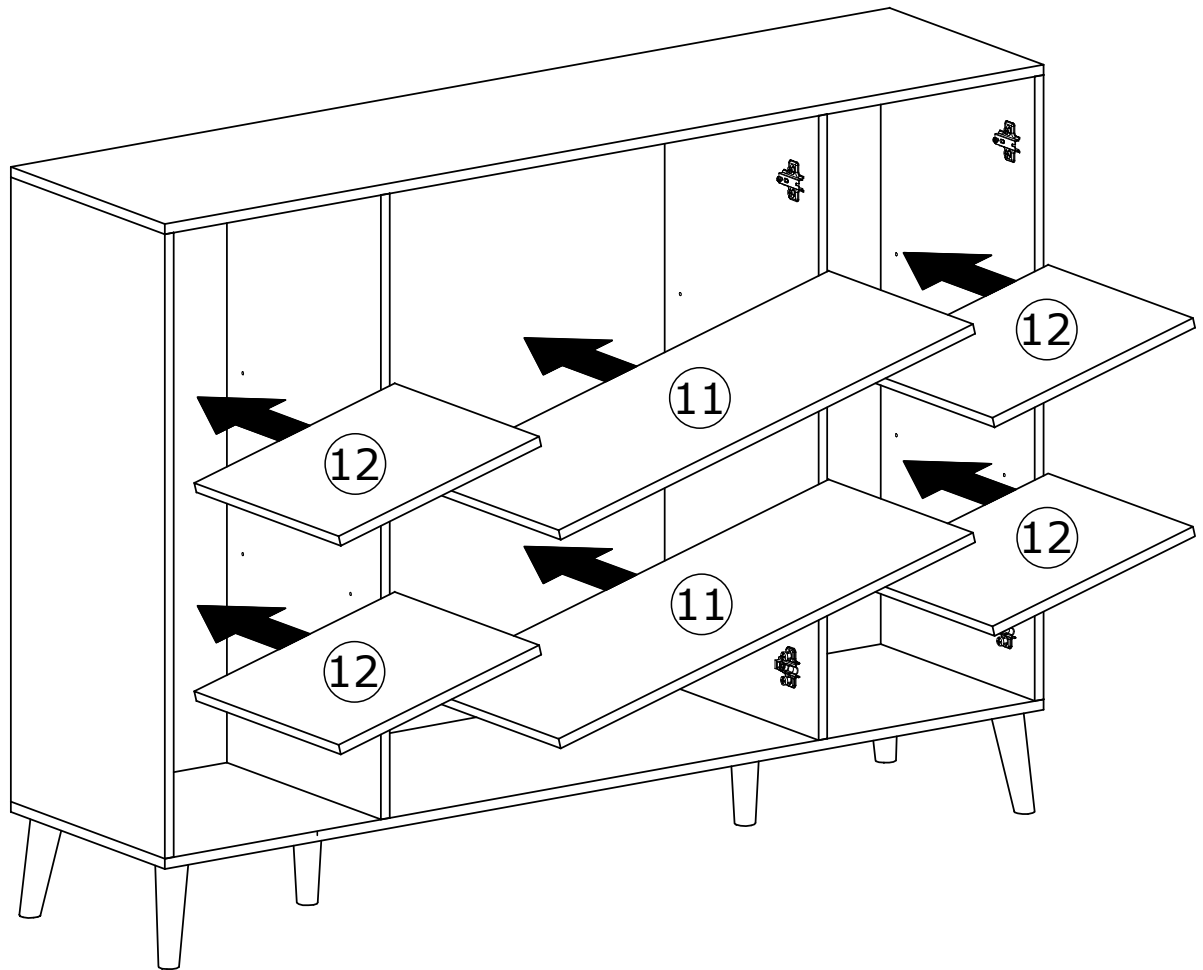

VI

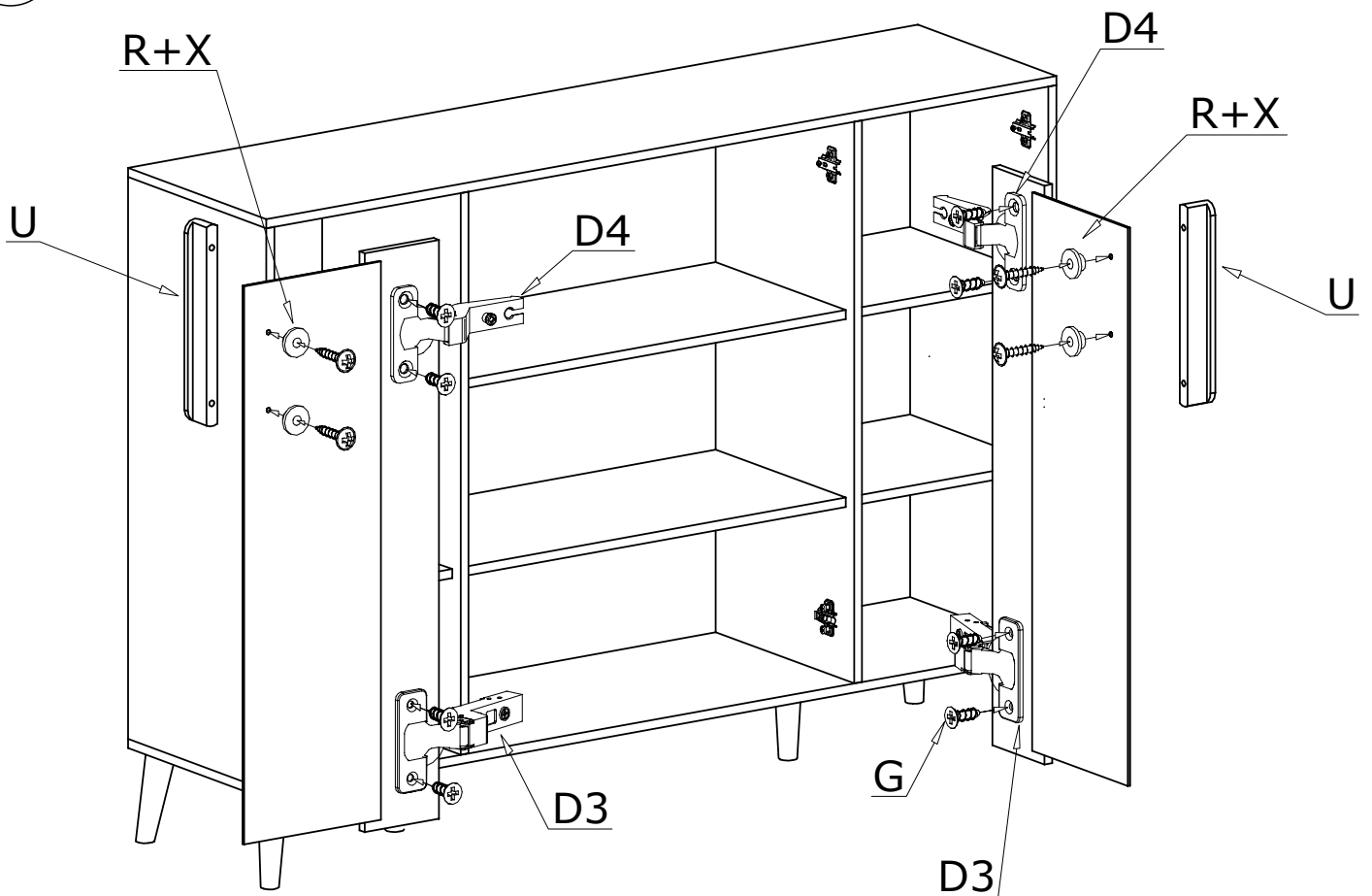

VII

