

BELLO 8

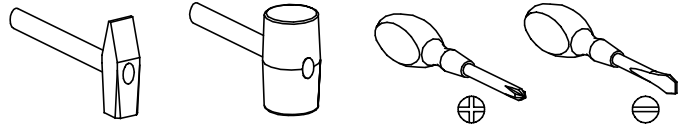

Narzędzia potrzebne do montażu



UWAGA !!!

MONTOWANIE USZKODZONYCH
ELEMENTÓW POWODUJE UTRATĘ
GWARANCJI

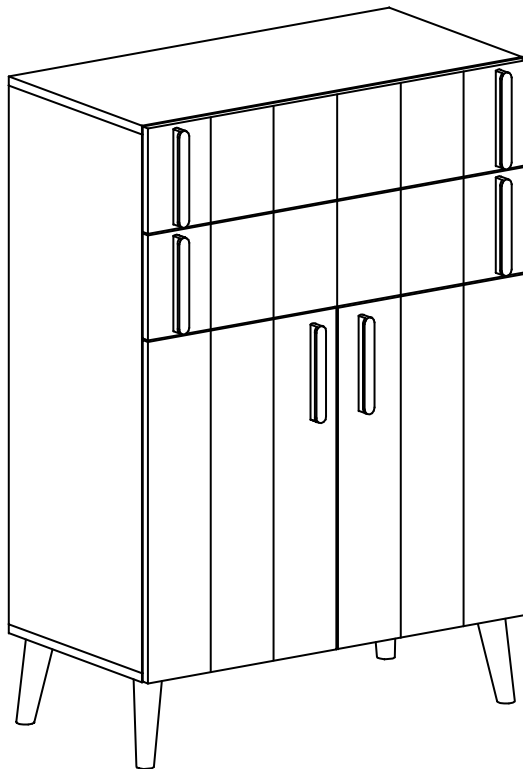

Nr	D[mm]	S[mm]	G[mm]	Ilość
1	801	405	16	1
2	801	405	16	1
3	975	405	16	1
4	975	405	16	1
5	775	405	16	1
6	998	796	2,5	1
7	617	402	16	1
8	617	402	16	1
9	718	150	16	2
10	748	355	2,5	2
11	807	190	16	2
12	350	150	16	2
13	350	150	16	2
14	333	120	16	2

UWAGA !!!

Mebel zawiera
elementy drewniane

W przypadku reklamacji proszę podać numer pakowacza znajdujący się na kartonie.

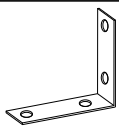

I - 2 St.

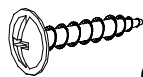

Q - 4 St.
3,5X16 mm



P - 4 St.

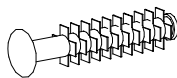

W - 8 St.

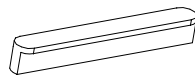

U - 6 St.

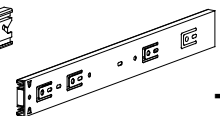
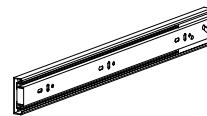

T - 1 Kpl.

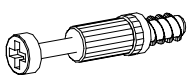

K - 12 St.



L - 12 St.

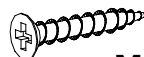

M - 36 St.
3x30 mm



N - 12 St.
3,5x25 mm

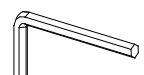

Z - 1 St.



E - 50 St.

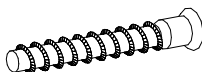

A - 16 St.

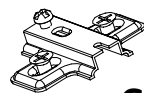

C2 - 2 St.

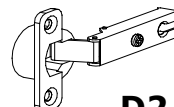

D2 - 2 St.



B - 12 St.



Y - 1 St.



J - 16 St.
5x13 mm

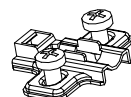

C1 - 2 St.

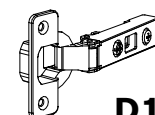

D1 - 2 St.



G - 14 St.
3,5x16 mm

I

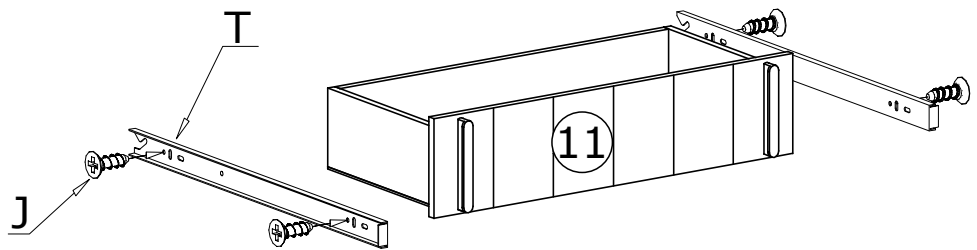
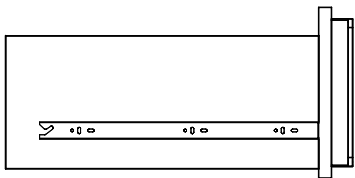
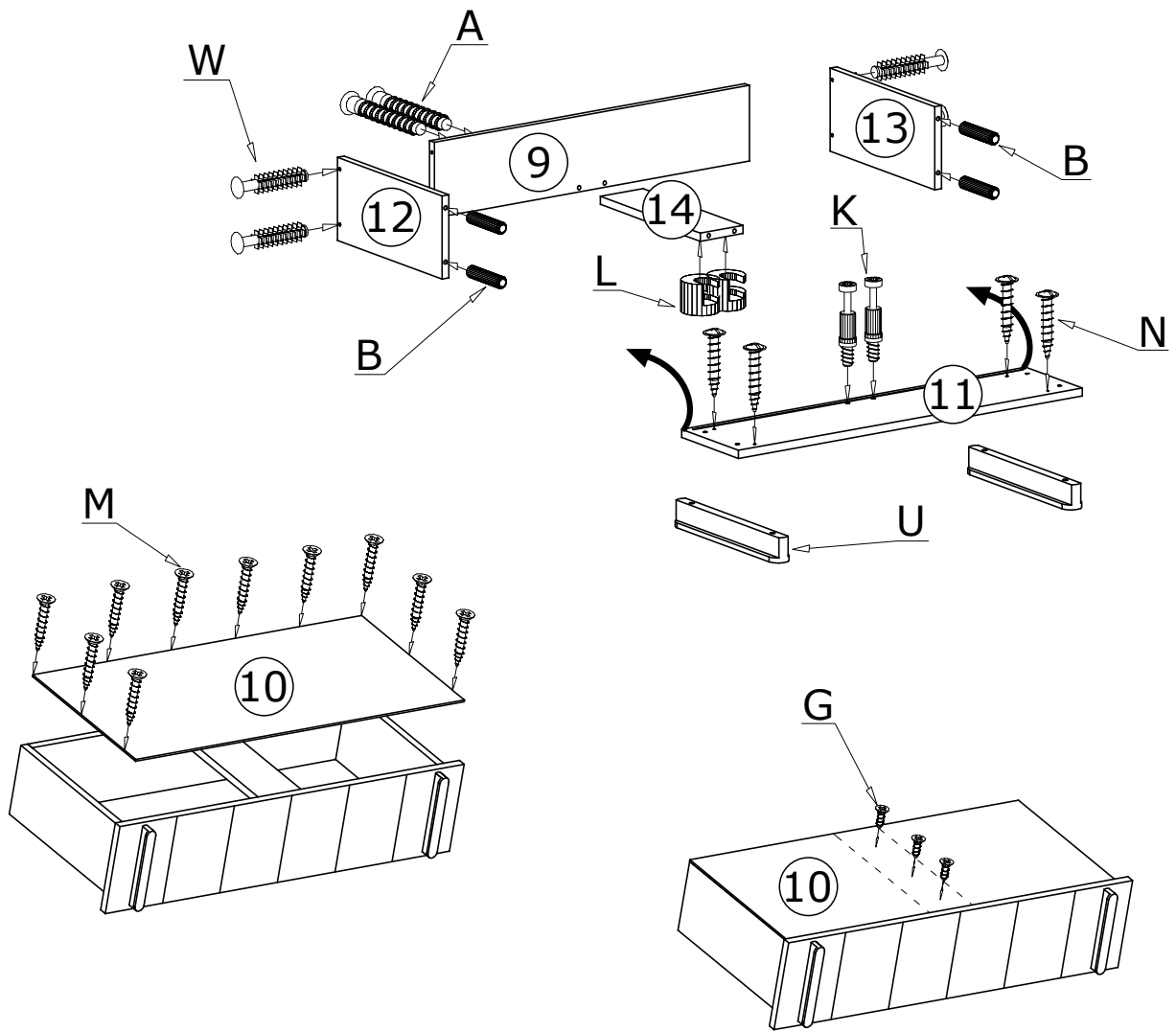

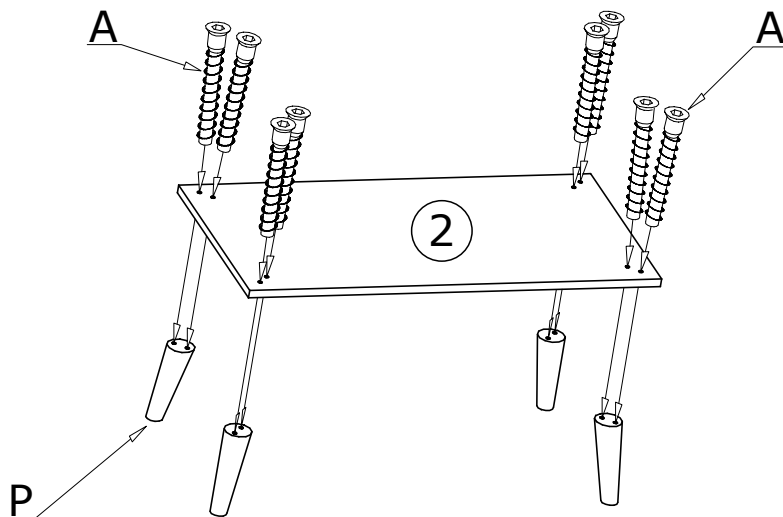

II

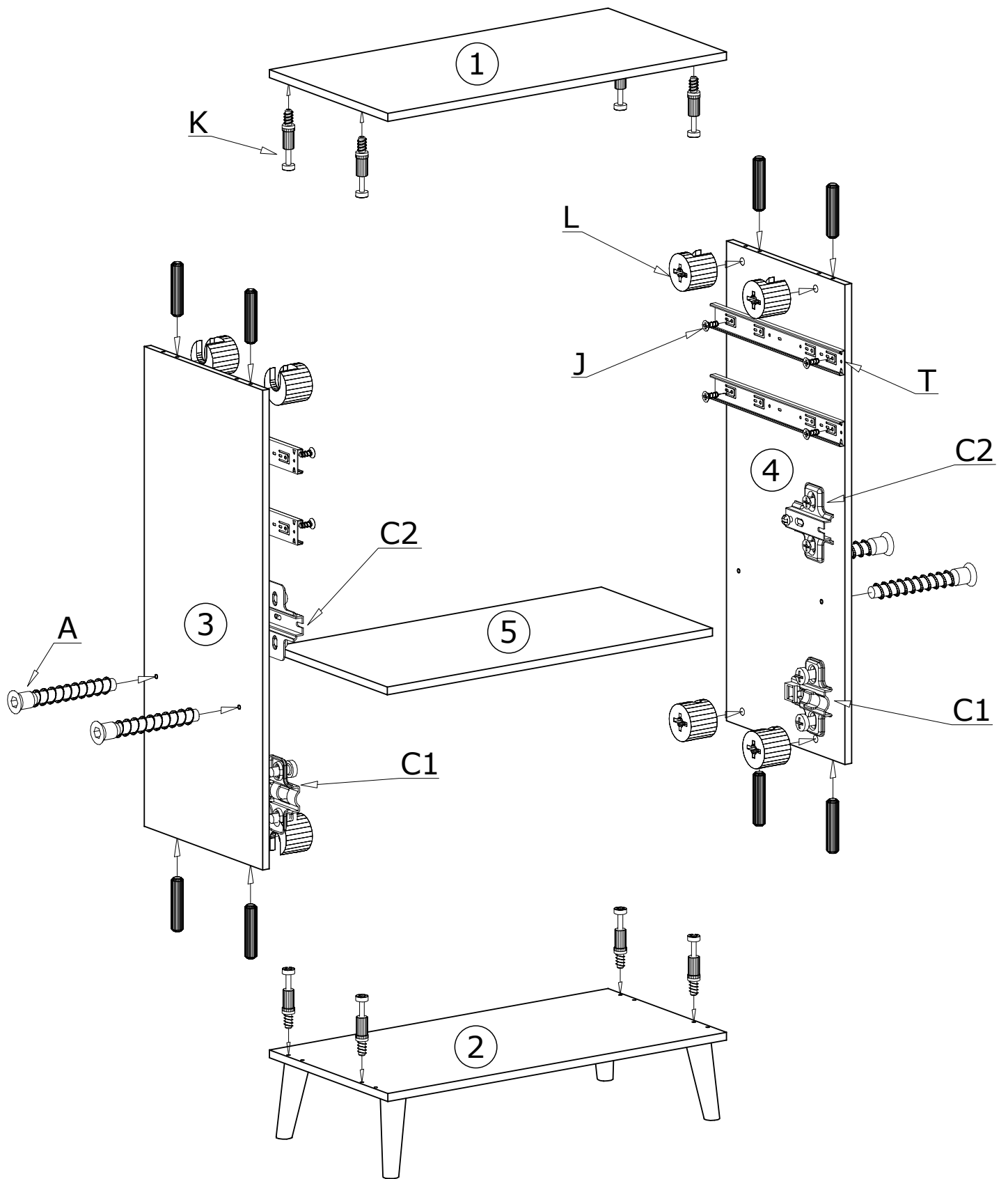

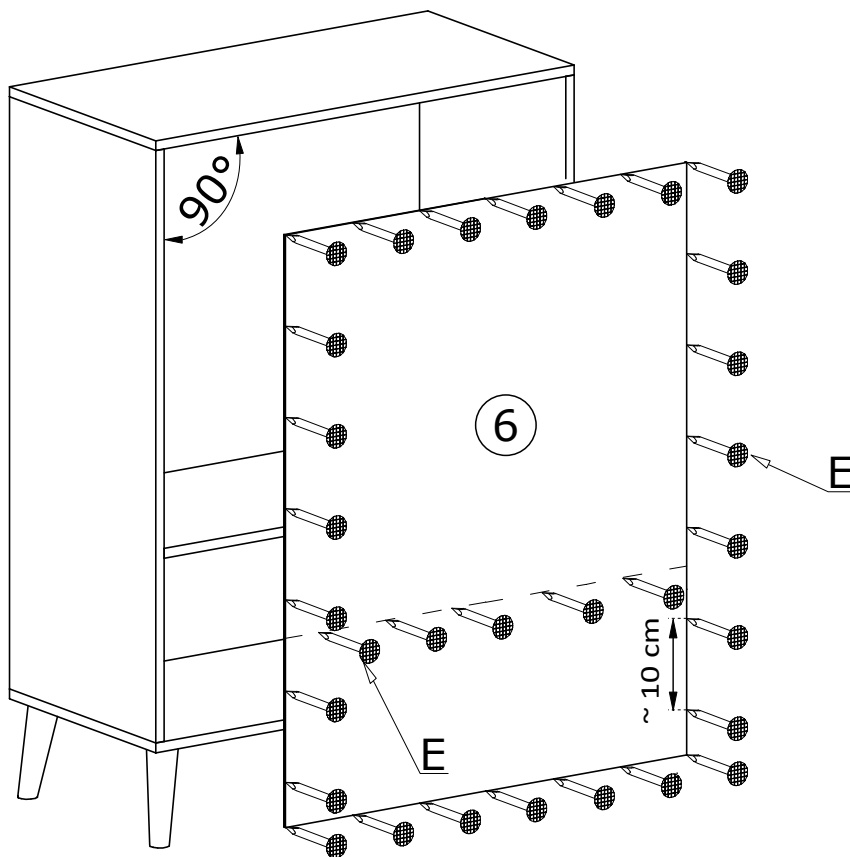

IV



60X 

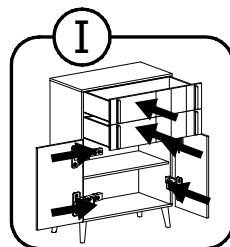
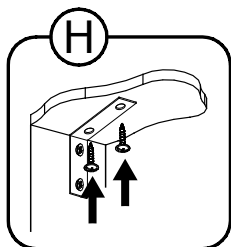
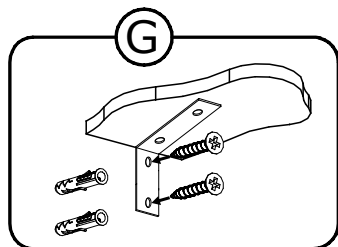
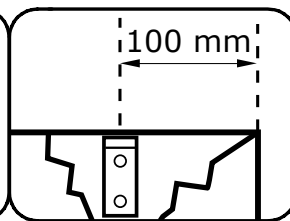
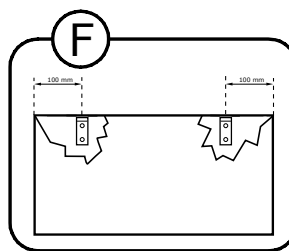
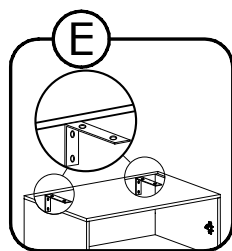
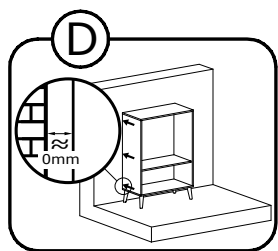
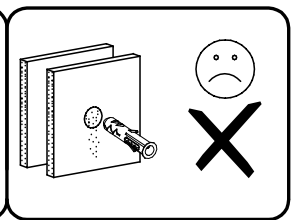
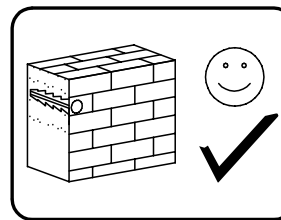
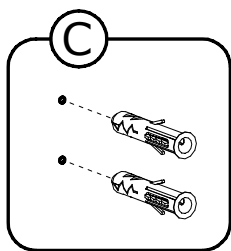
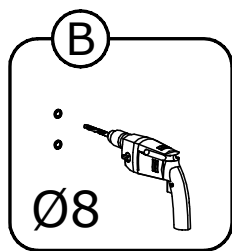
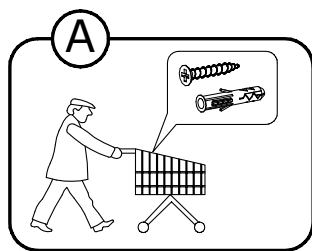

Meble zawierają elementy drewniane, których barwa i układ słojów są uzależnione od wielu czynników, dlatego mogą występować różnice w fakturze i barwie co nie stanowi wady produktu i nie wpływa na jego jakość, trwałość i funkcjonalność.

Elementy drewniane mogą ujawniać niewielkie zmiany w kształcie i wymiarach wywołane specyficznymi warunkami eksploatacji takimi jak: wilgotność, różnice temperatur, etc.

V

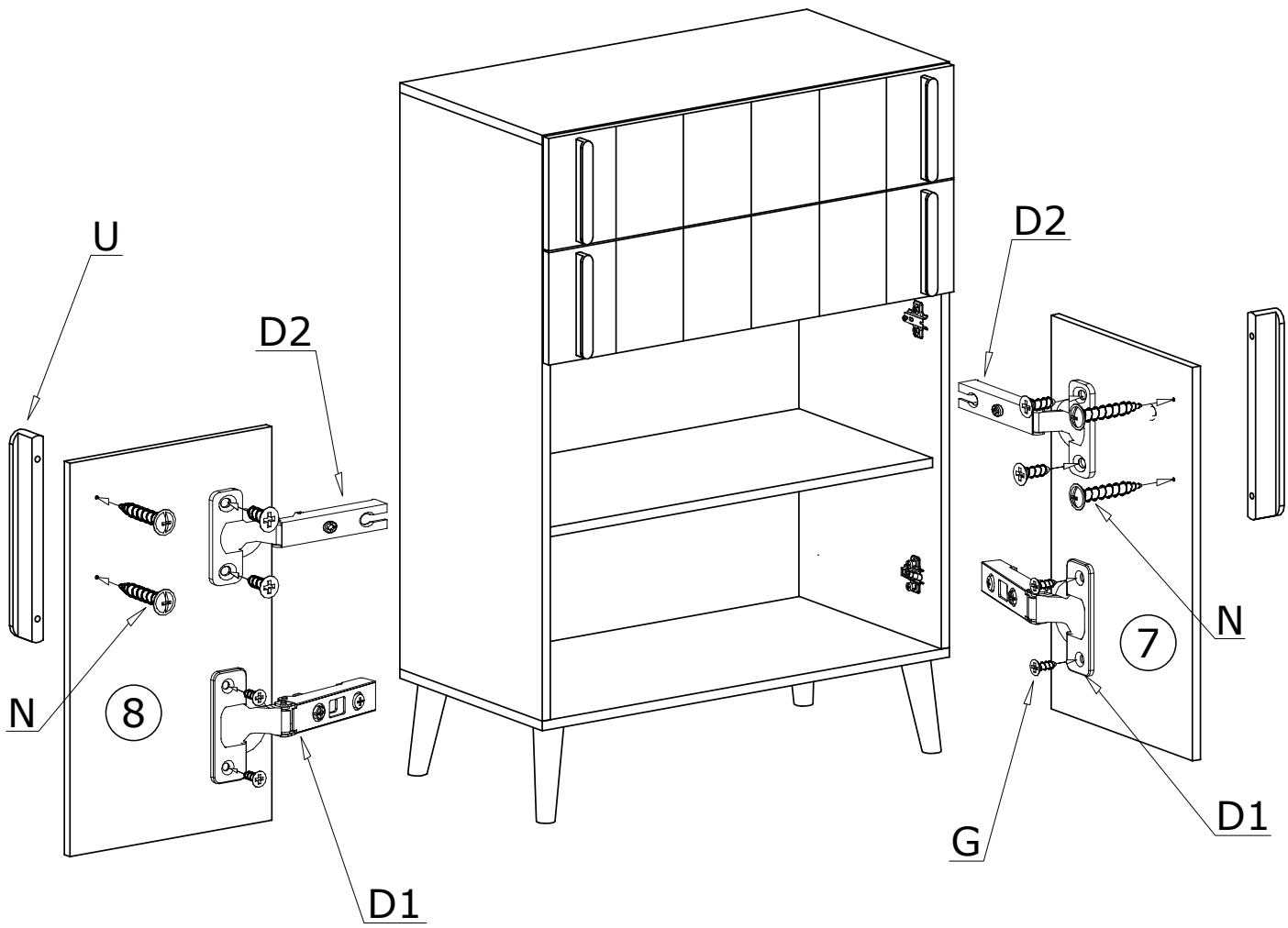

MONTAŻ/DEMONTAŻ PROWADNIC

1



2



3

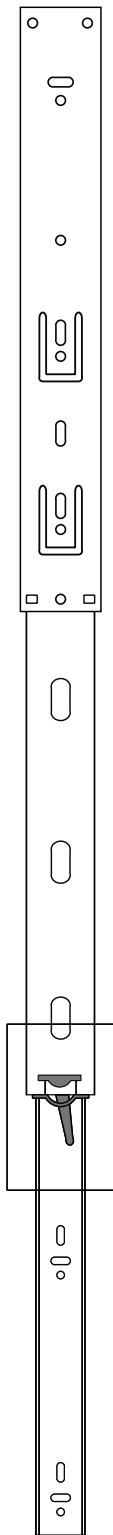

4

