

BELLO 6

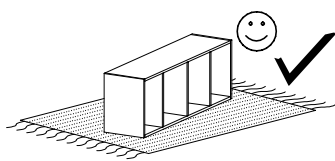

Narzędzia potrzebne do montażu



UWAGA !!!

MONTOWANIE USZKODZONYCH
ELEMENTÓW POWODUJE UTRATĘ
GWARANCJI

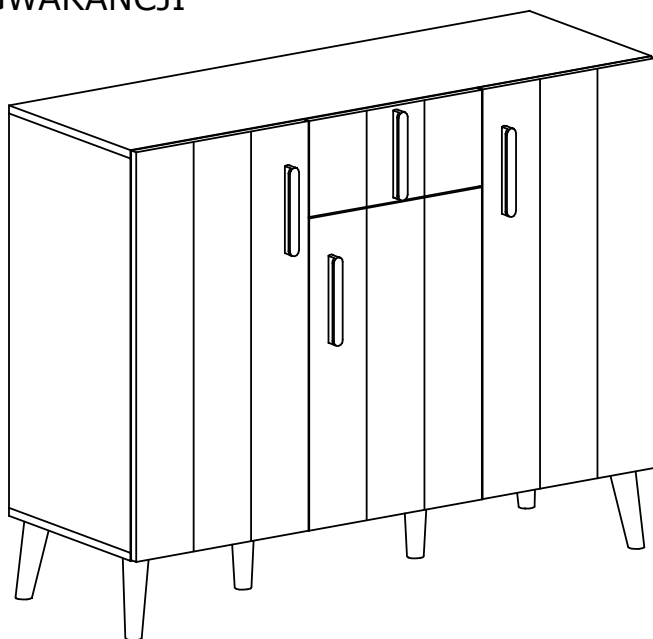

Nr	D[mm]	S[mm]	G[mm]	Ilość
1	1214	405	16	1
2	1214	405	16	1
3	780	405	16	1
4	780	405	16	1
5	780	405	16	1
6	780	405	16	1
7	1205	800	2,5	1
8	617	402	16	1
9	810	402	16	1
10	810	402	16	1
11	402	190	16	1
12	350	150	16	1
13	350	150	16	1
14	325	150	16	1
15	355	355	2,5	1
16	382	380	16	3

UWAGA !!!

Mebel zawiera
elementy drewniane

W przypadku reklamacji proszę podać numer pakowacza znajdujący się na kartonie.

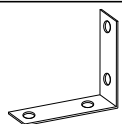

I - 2 St.

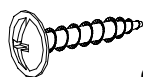

Q - 4 St.
3,5X16 mm

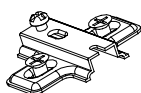

C4 - 1 St.

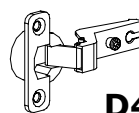

D4 - 1 St.



F - 12 St.



M - 15 St.
3x30 mm

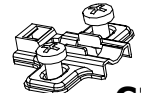

C3 - 1 St.

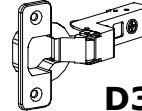

D3 - 1 St.

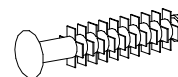

W - 4 St.

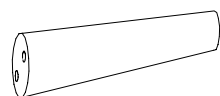

P1 - 4 St.



P2 - 2 St.

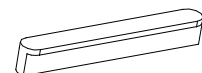

U - 4 St.

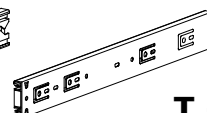
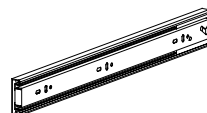

T - 1 Kpl.

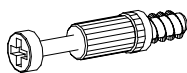

K - 16 St.



L - 16 St.

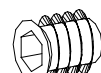

S - 2 St.



N - 4 St.
3,5x25 mm

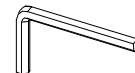

Z - 1 St.



E - 70 St.

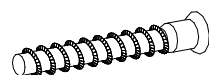

A - 8 St.

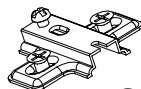

C2 - 2 St.

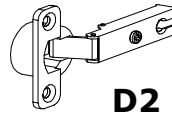

D2 - 2 St.



B - 20 St.



Y - 1 St.



J - 8 St.
5x13 mm

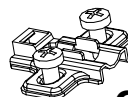

C1 - 2 St.

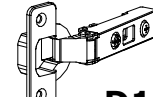

D1 - 2 St.



G - 12 St.
3,5x16 mm

I

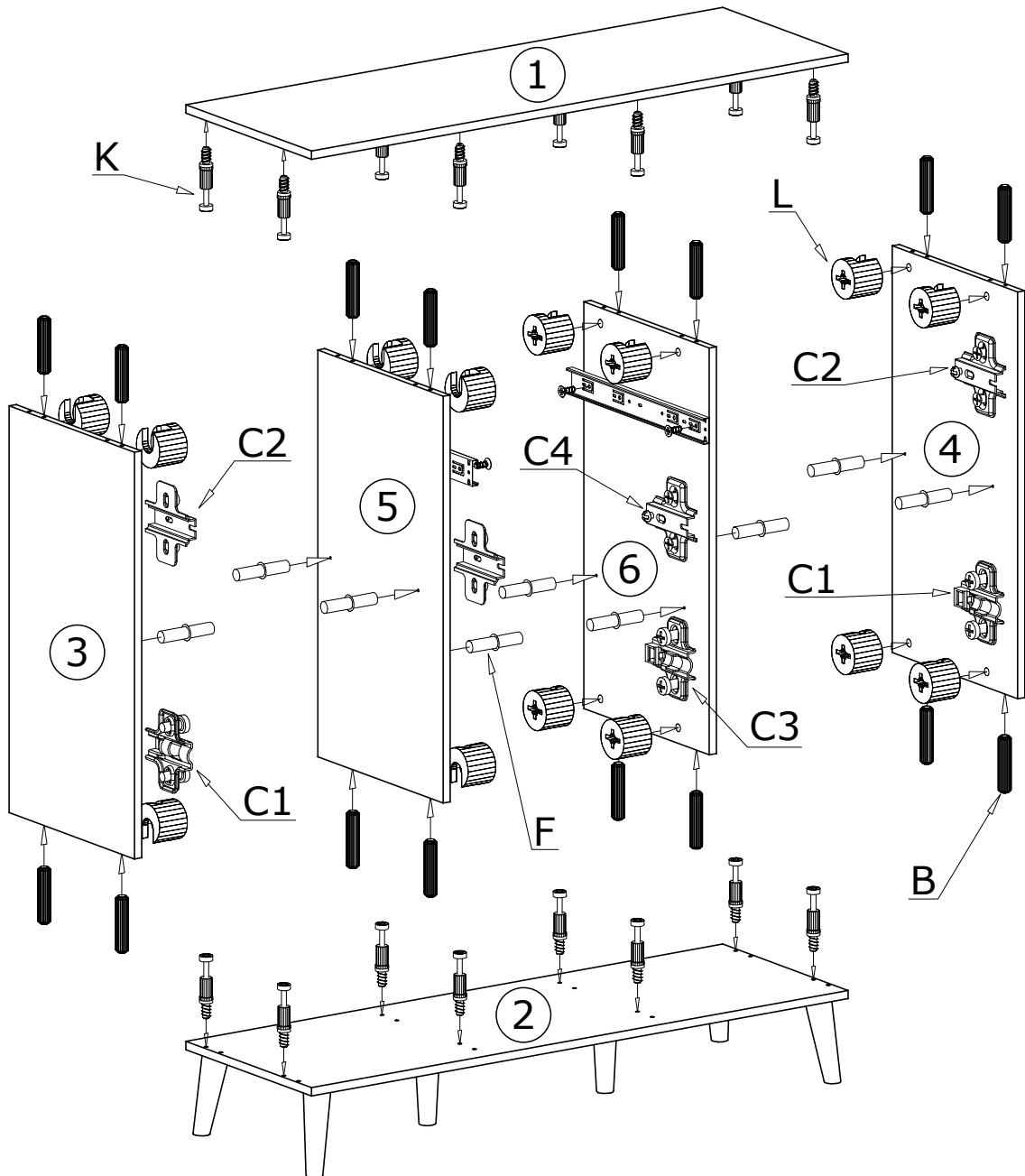
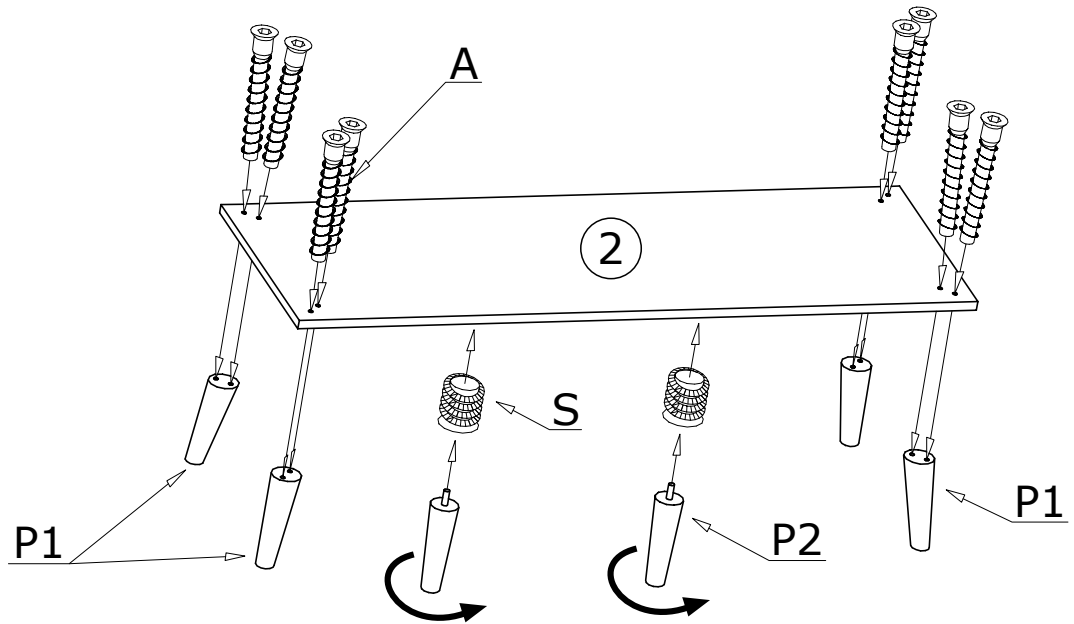

II

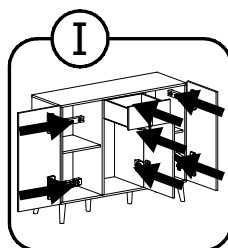
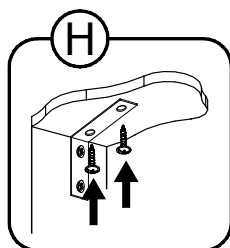
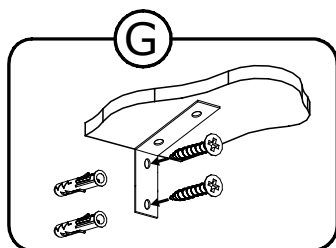
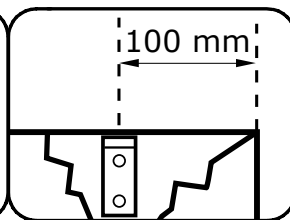
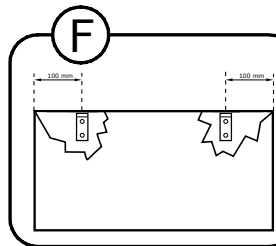
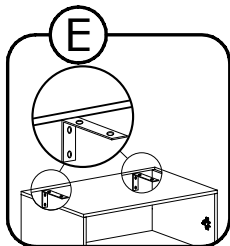
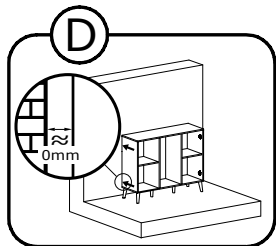
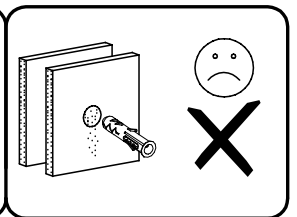
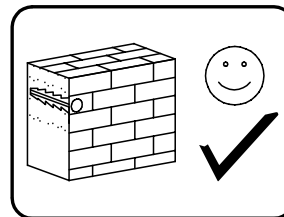
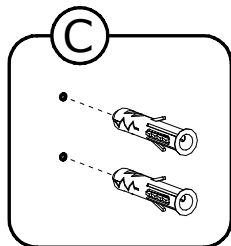
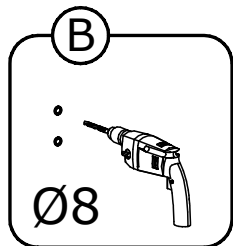
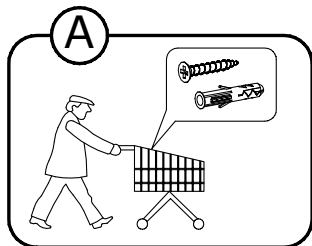
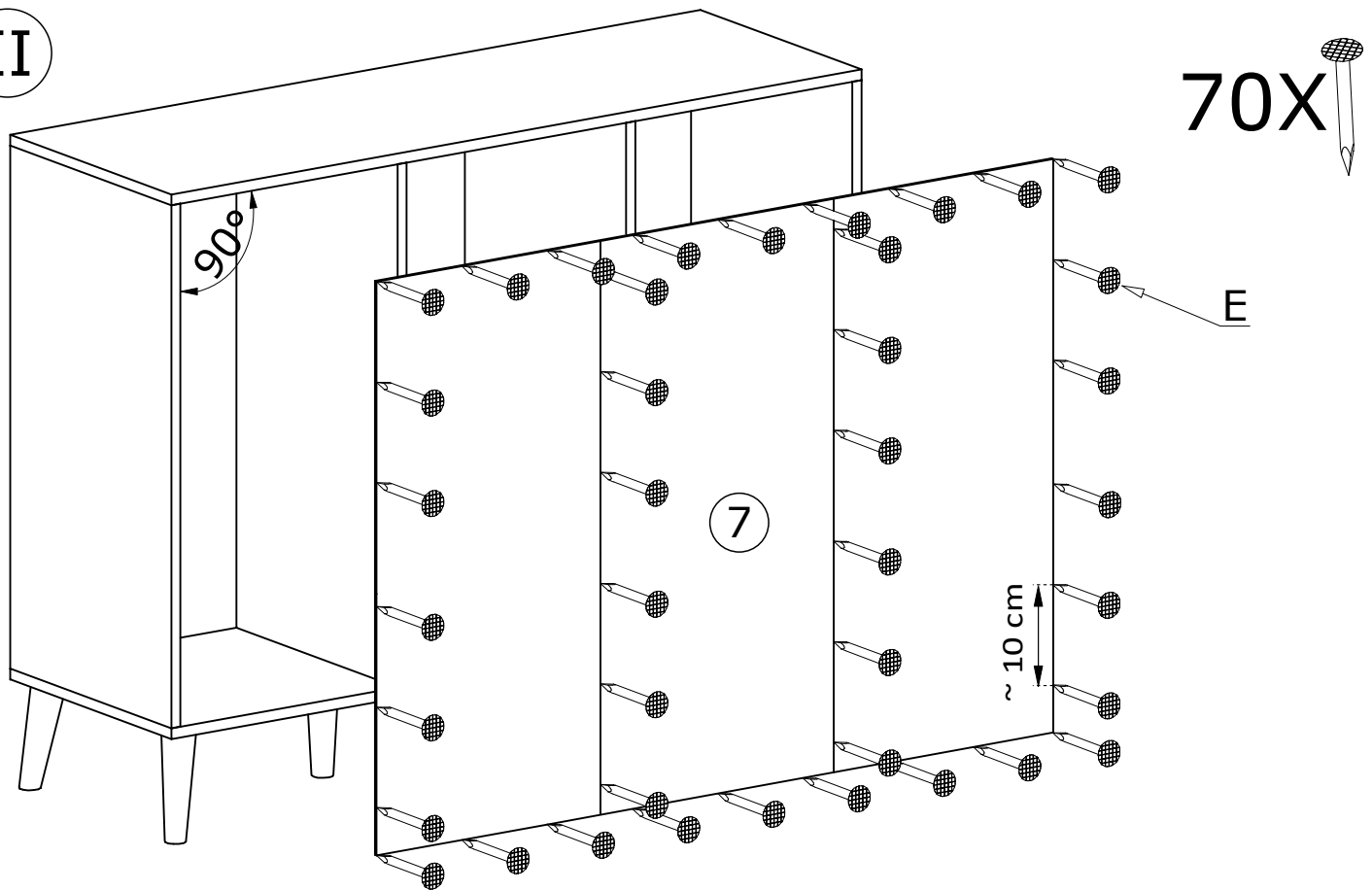

Meble zawierają elementy drewniane, których barwa i układ słoju są uzależnione od wielu czynników, dlatego mogą występować różnice w fakturze i barwie co nie stanowi wady produktu i nie wpływa na jego jakość, trwałość i funkcjonalność.

Elementy drewniane mogą ujawniać niewielkie zmiany w kształcie i wymiarach wywołane specyficznymi warunkami eksploatacji takimi jak: wilgotność, różnice temperatur, etc.

III

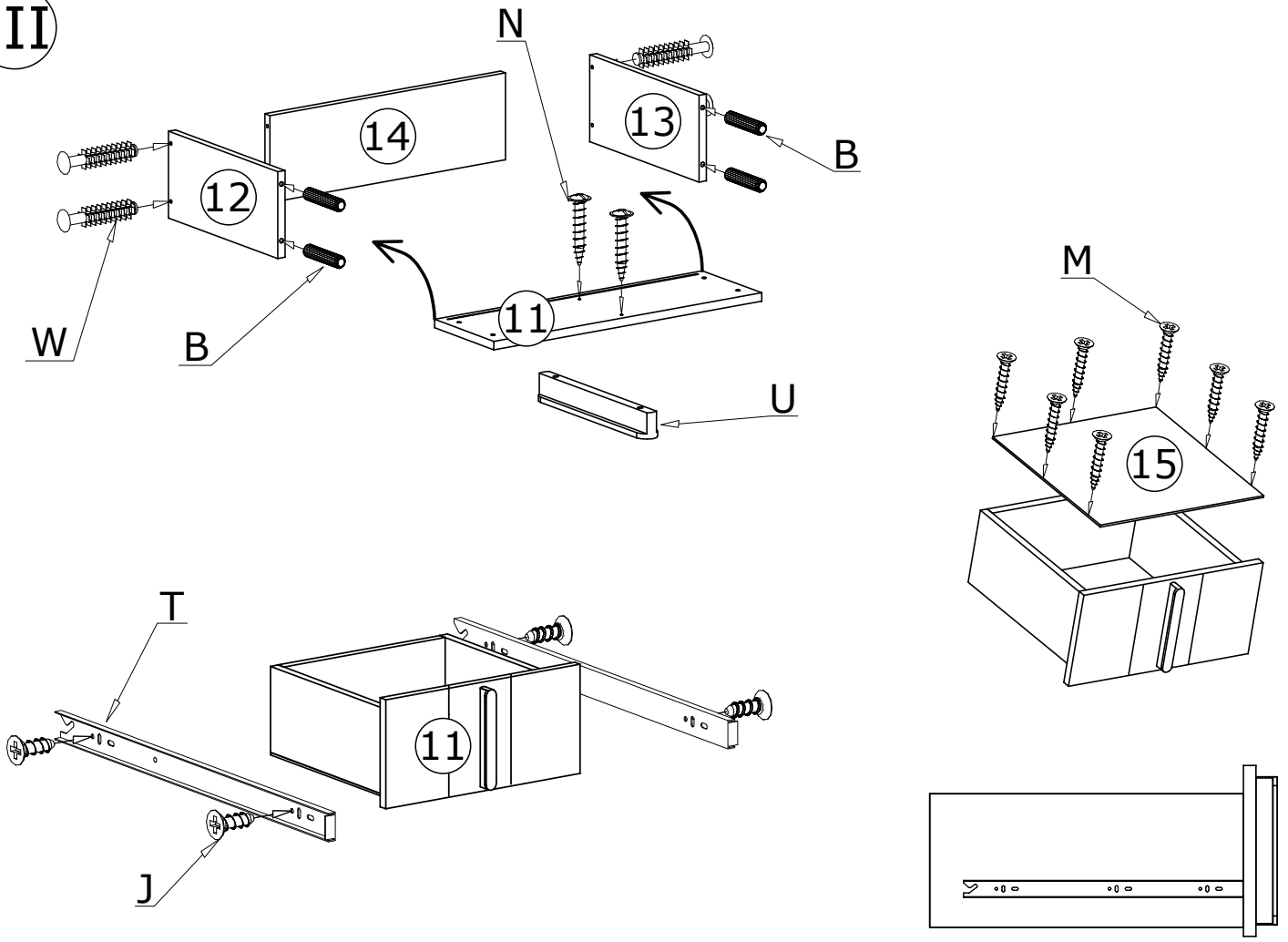

IV

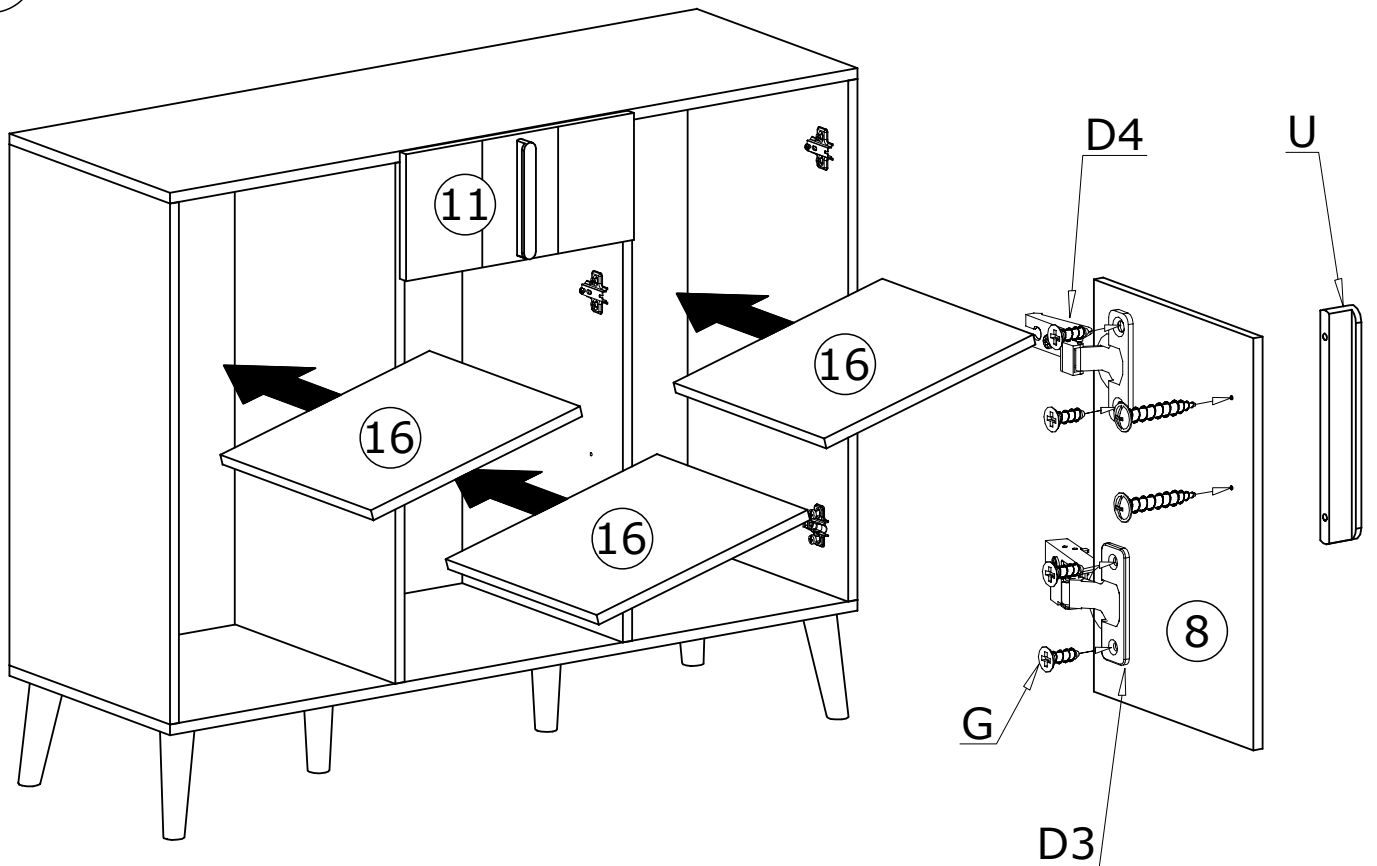

V

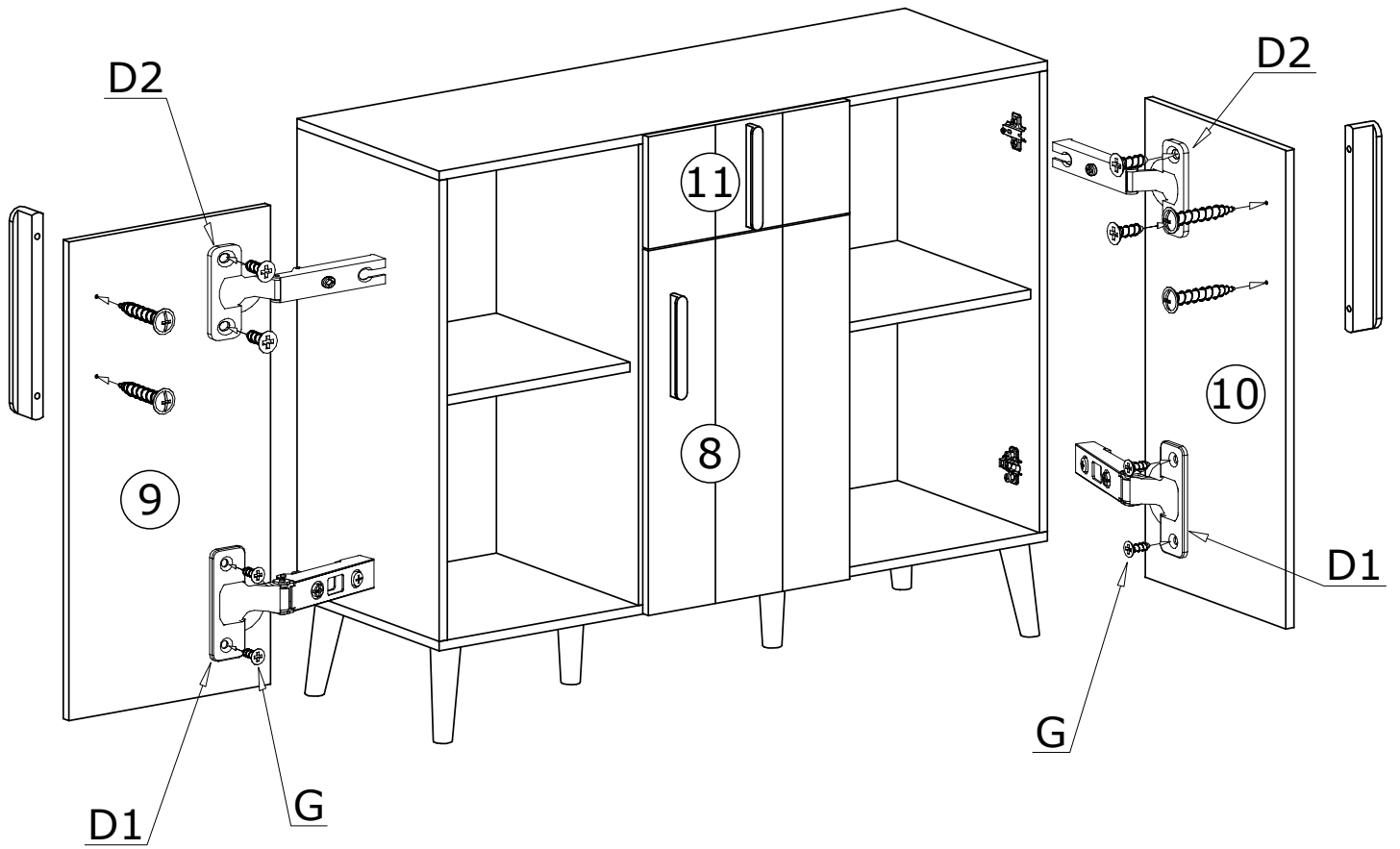

MONTAŻ/DEMONTAŻ PROWADNIC

1

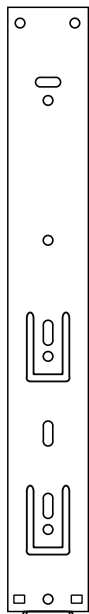

2

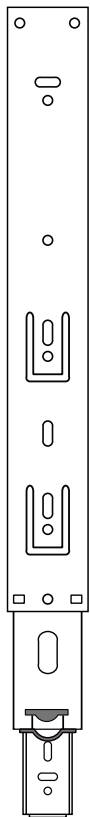

3

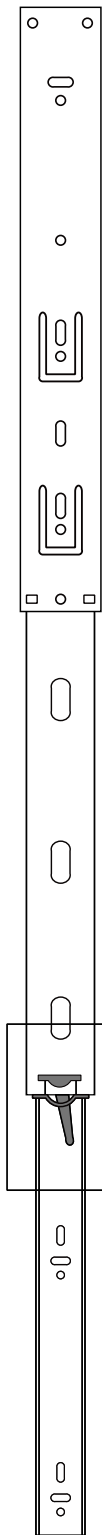

4

