

BELLO 3



Narzędzia potrzebne do montażu



UWAGA !!!

MONTOWANIE USZKODZONYCH
ELEMENTÓW POWODUJE UTRATĘ
GWARANCJI

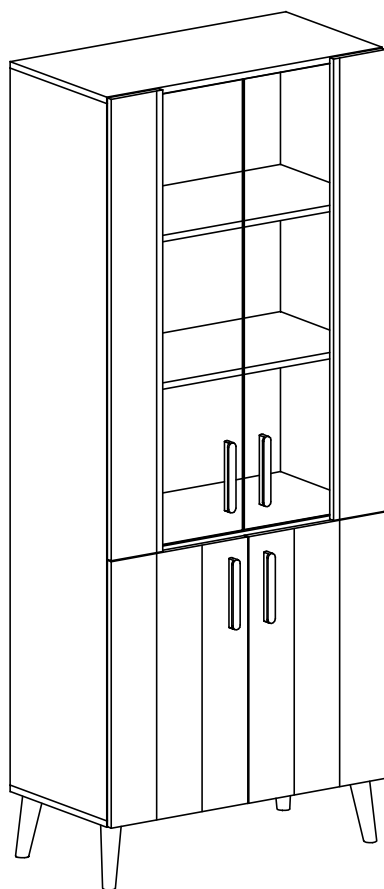

Nr	D[mm]	S[mm]	G[mm]	Ilość
1	810	405	16	1
2	810	405	16	1
3	1790	405	16	1
4	1790	405	16	1
5	776	405	16	1
6	1820	796	2,5	1
7	776	380	16	3
8	665	402	16	1
9	665	402	16	1
10	1128	290	4	1
11	1128	290	4	1
12	1152	152	16	2

UWAGA !!!

Mebel zawiera
elementy drewniane

W przypadku reklamacji proszę podać numer pakowacza znajdujący się na kartonie.

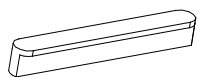

U - 4 St.



X - 4 St.
3,5x20 mm

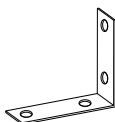

Y - 2 St.

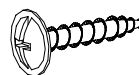

Q - 4 St.
3,5x16 mm



P - 4 St.



F - 12 St.



R - 10 St.



N - 4 St.
3,5x25 mm

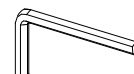

Z - 1 St.

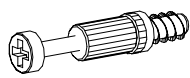

K - 8 St.



L - 8 St.

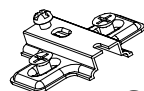

C2 - 6 St.

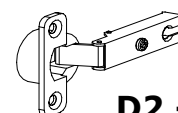

D2 - 6 St.



B - 12 St.



E - 70 St.

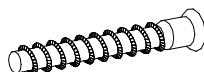

W - 12 St.

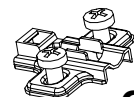

C1 - 4 St.

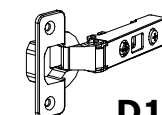

D1 - 4 St.

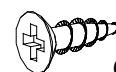

G - 26 St.
3,5x16 mm

I

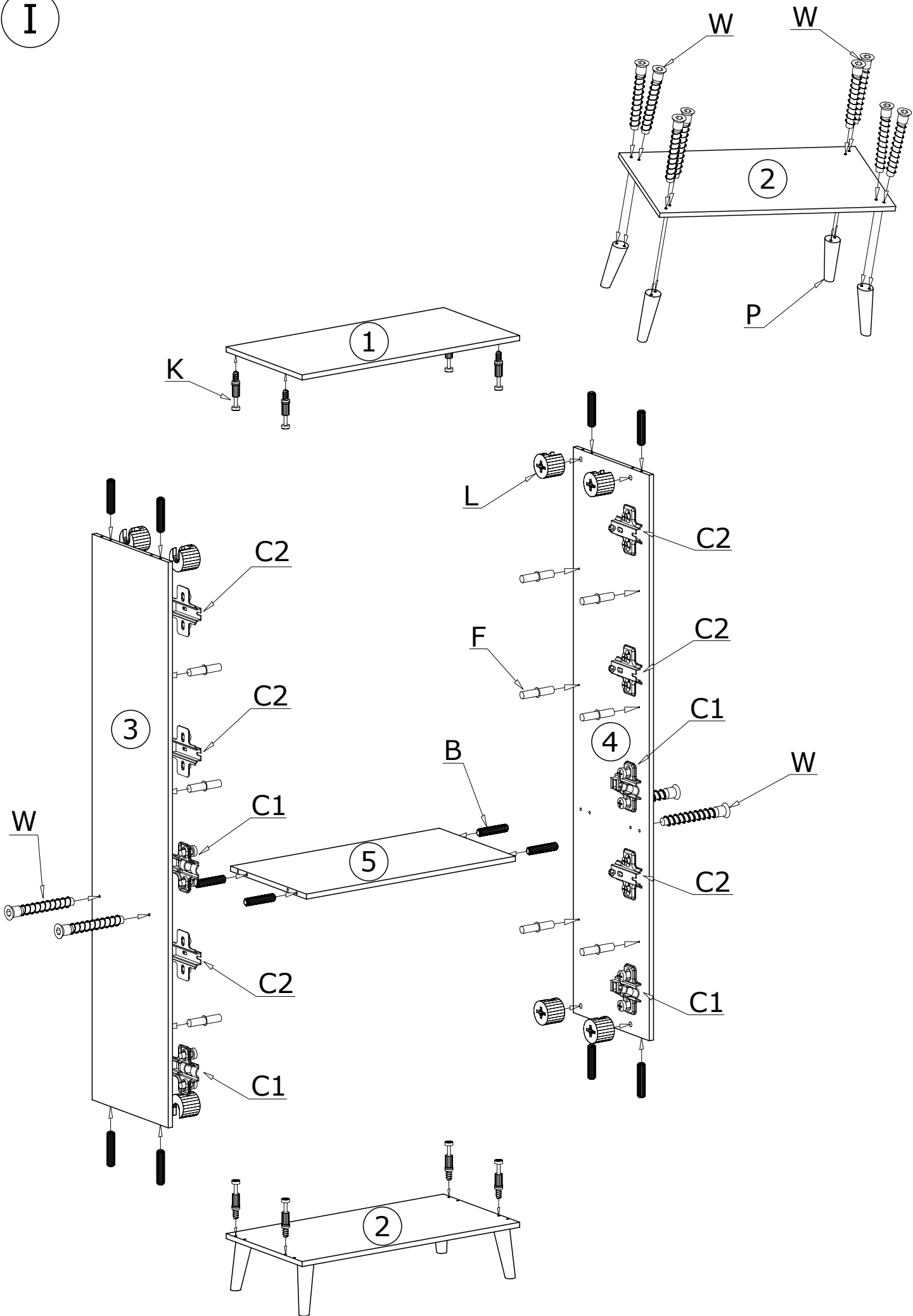

II

90X 

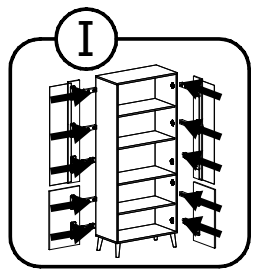
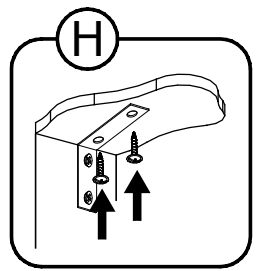
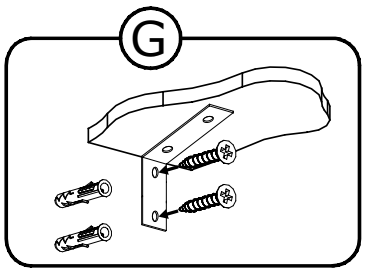
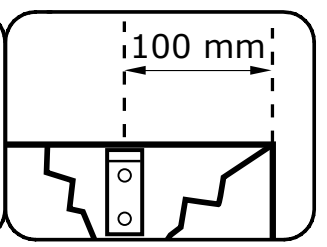
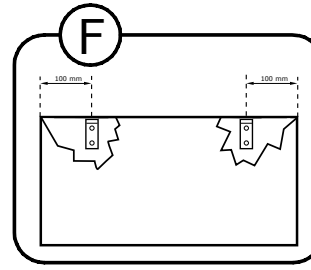
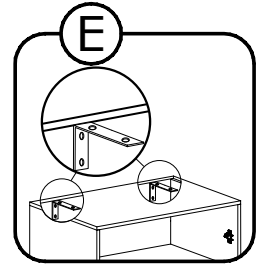
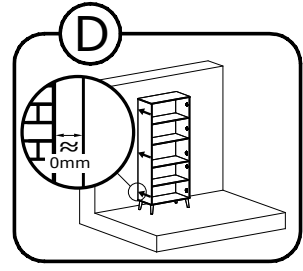
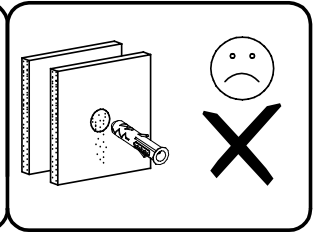
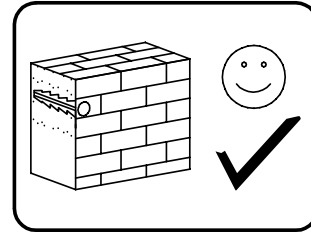
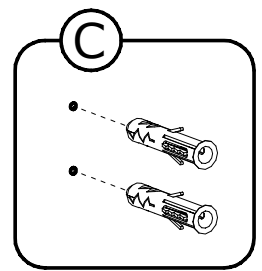
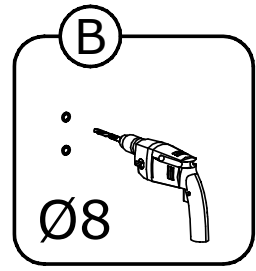
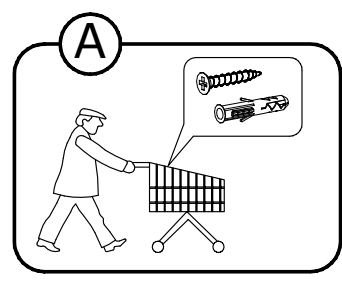
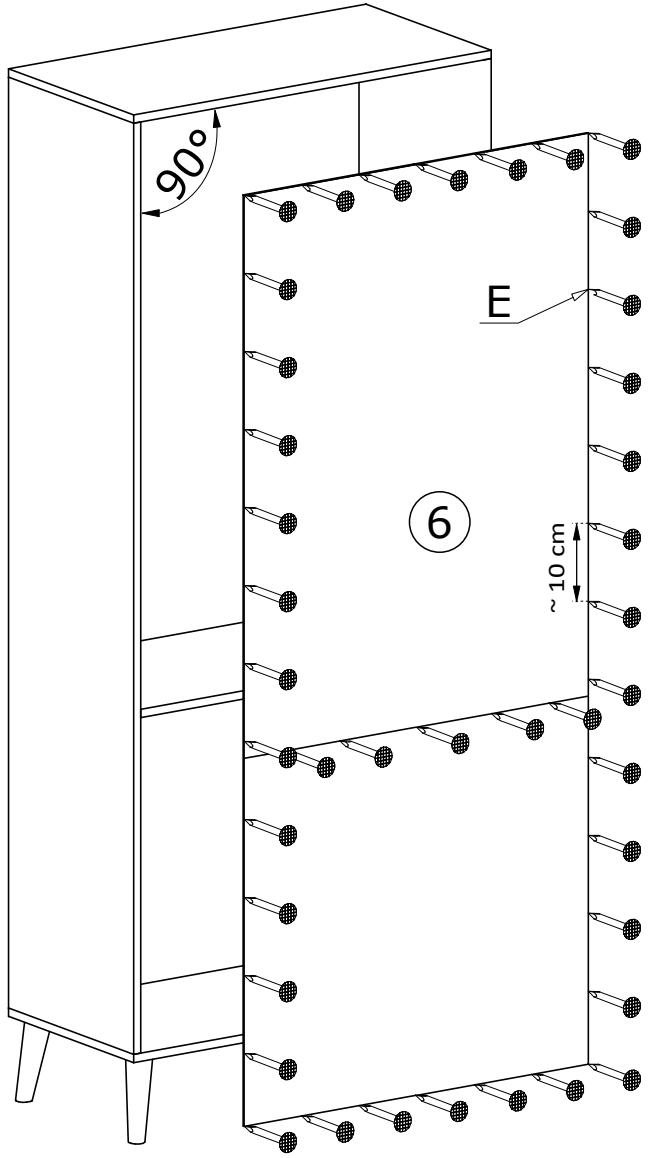

Meble zawierają elementy drewniane, których barwa i układ słoju są uzależnione od wielu czynników, dlatego mogą występować różnice w fakturze i barwie co nie stanowi wady produktu i nie wpływa na jego jakość, trwałość i funkcjonalność.

Elementy drewniane mogą ujawniać niewielkie zmiany w kształcie i wymiarach wywołane specyficznymi warunkami eksploatacji takimi jak: wilgotność, różnice temperatur, etc.

III

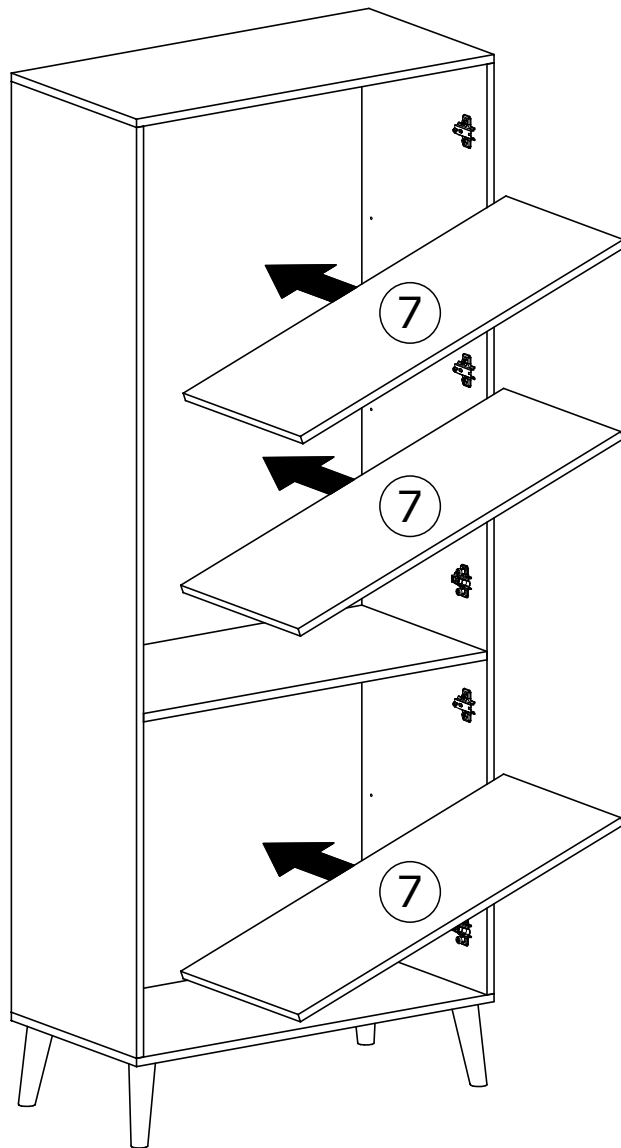

IV

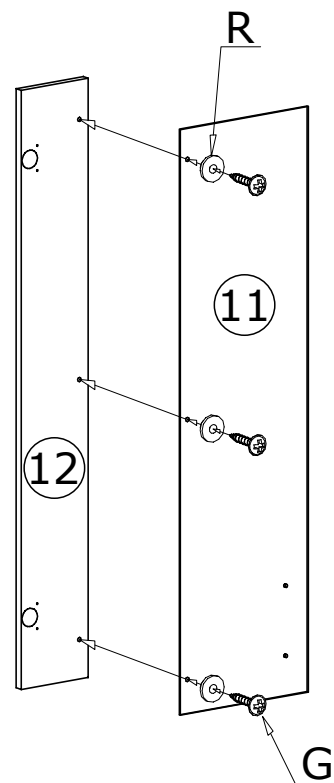
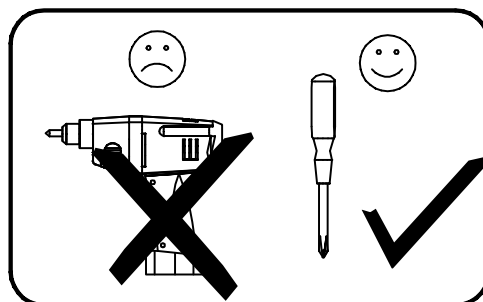
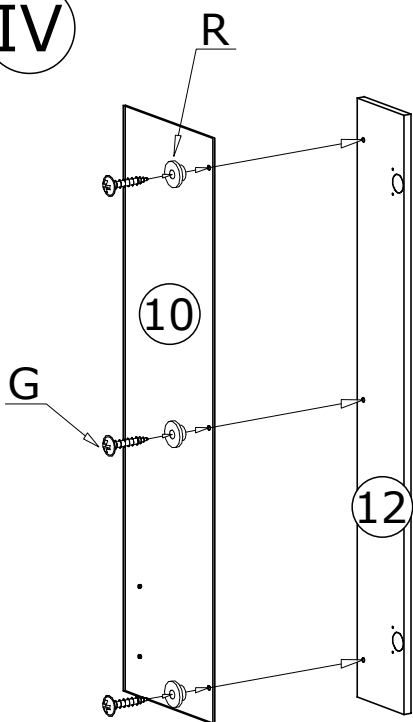

V

