

BELLO 2

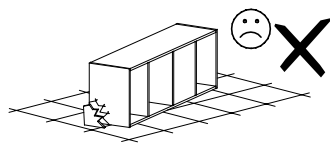

Narzędzia potrzebne do montażu

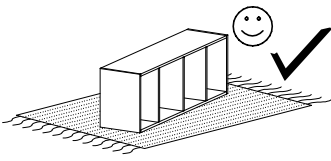
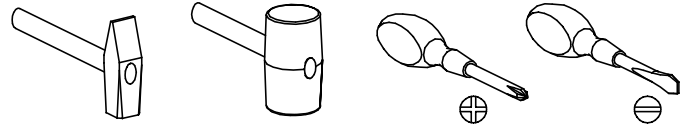

UWAGA !!!

MONTOWANIE USZKODZONYCH
ELEMENTÓW POWODUJE UTRATĘ
GWARANCJI

Nr	D[mm]	S[mm]	G[mm]	Ilość
1	540	540	16	1
2	540	540	16	1
3	1790	540	16	1
4	1790	540	16	1
5	507	540	16	2
6	1820	530	2,5	1
7	1819	537	16	1



UWAGA !!!

Mebel zawiera
elementy drewniane

W przypadku reklamacji proszę podać numer pakowacza znajdujący się na kartonie.

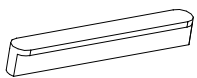

U - 1 St.

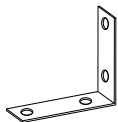

I - 1 St.

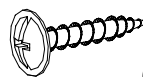

Q - 2 St.
4x25 mm



P - 4 St.



R - 1 St.
500 mm

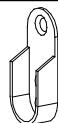

Y - 2 St.



N - 2 St.
3x25 mm

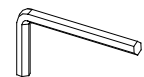

Z - 1 St.

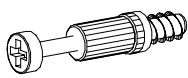

K - 12 St.



L - 12 St.



C2 - 2 St.

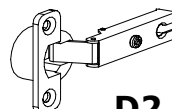

D2 - 2 St.



B - 12 St.



E - 90 St.

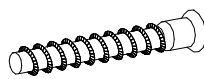

W - 16 St.

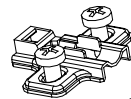

C1 - 2 St.

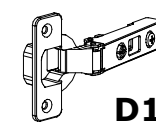

D1 - 2 St.

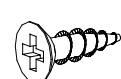

G - 12 St.
3,5x16 mm

I

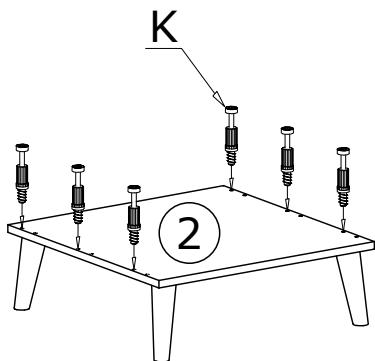
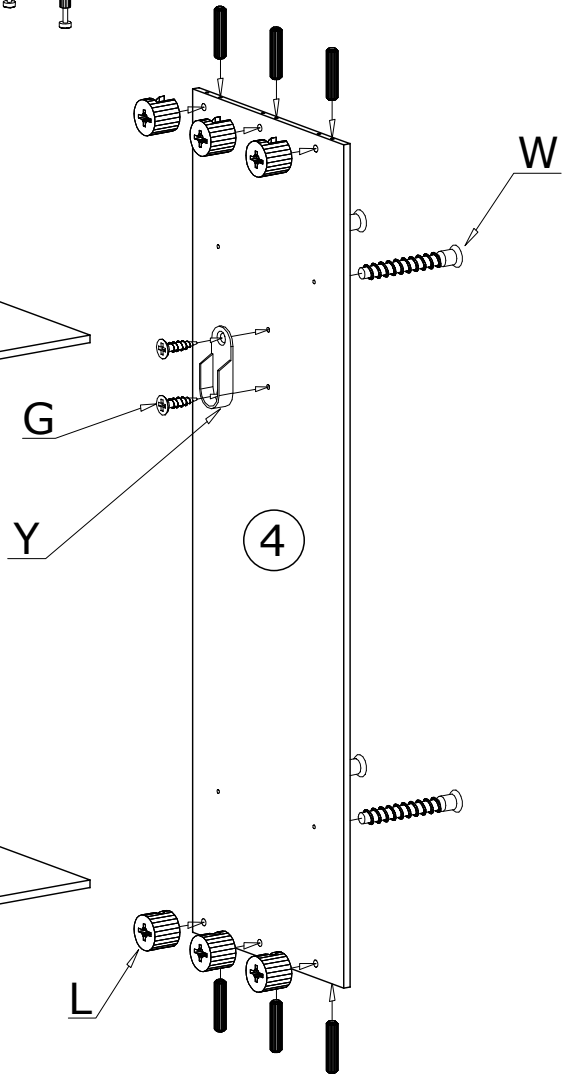
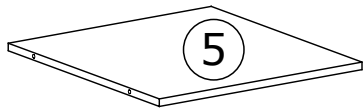
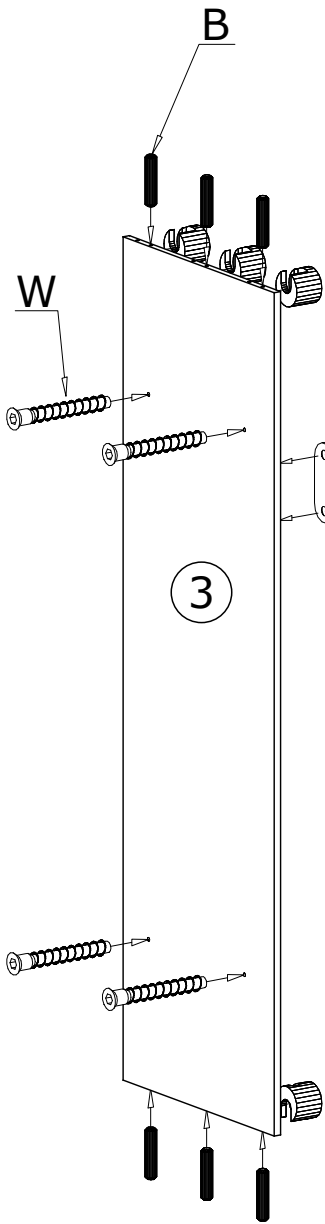
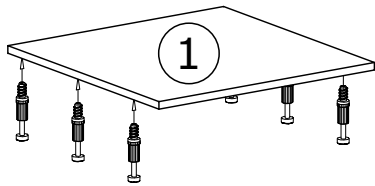
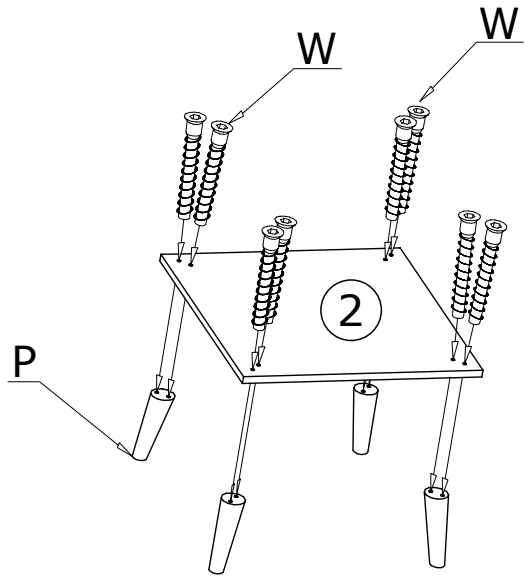

II

90X

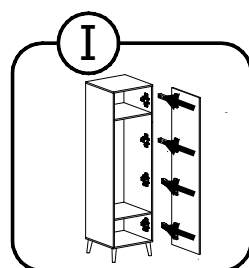
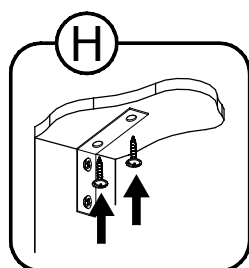
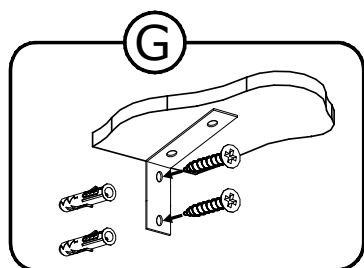
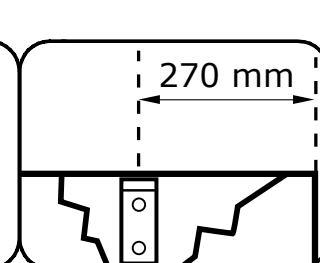
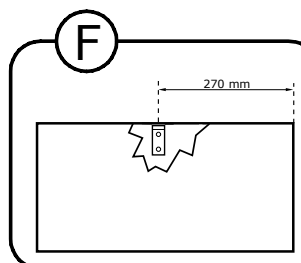
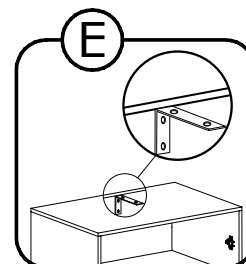
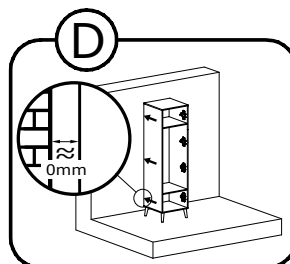
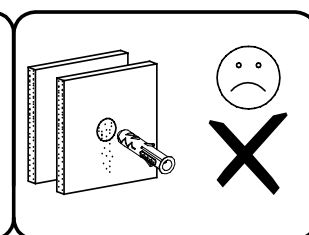
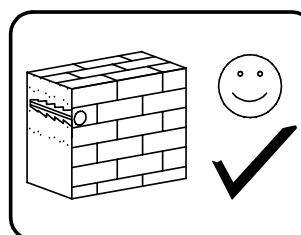
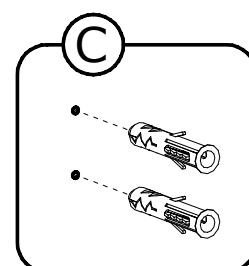
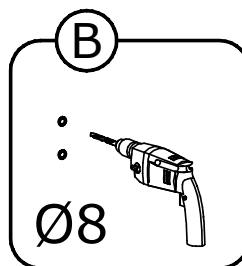
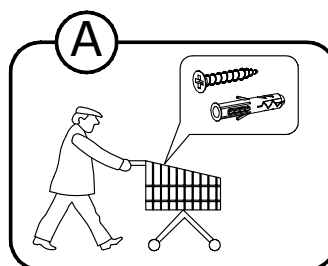
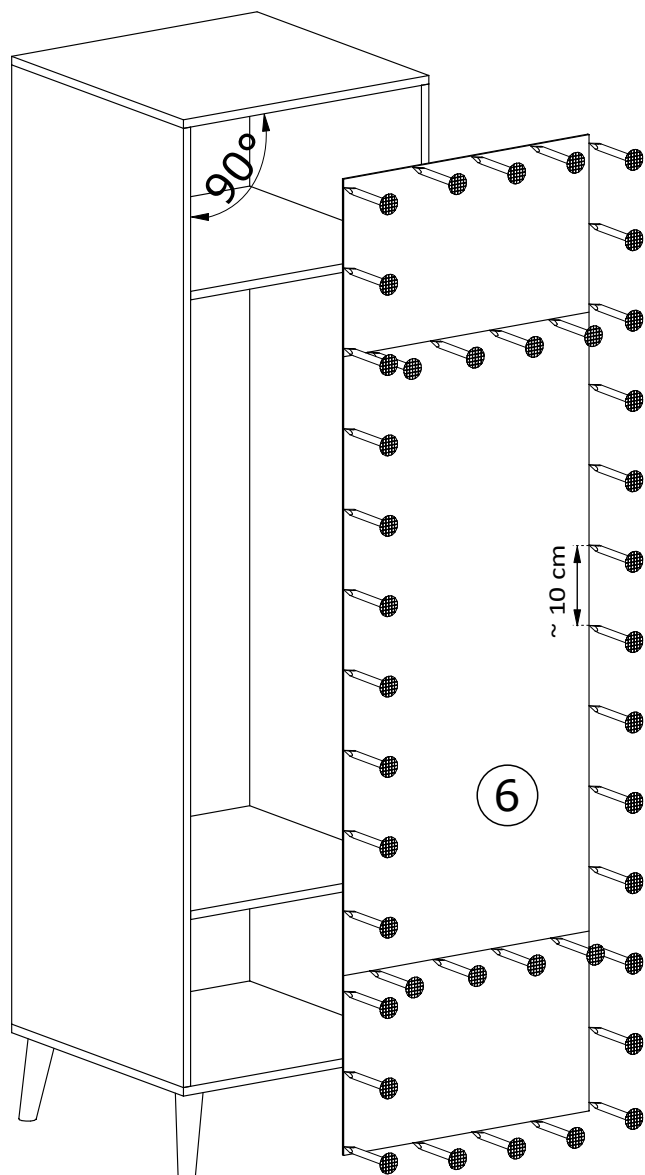

Meble zawierają elementy drewniane, których barwa i układ słoików są uzależnione od wielu czynników, dlatego mogą występować różnice w fakturze i barwie co nie stanowi wady produktu i nie wpływa na jego jakość, trwałość i funkcjonalność.

Elementy drewniane mogą ujawniać niewielkie zmiany w kształcie i wymiarach wywołane specyficznymi warunkami eksploatacji takimi jak: wilgotność, różnice temperatur, etc.

III

