

ANTICA 146

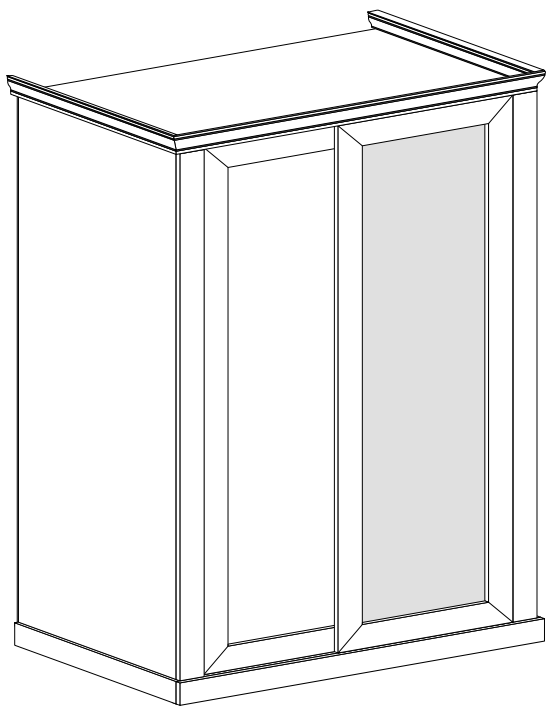

Narzędzia potrzebne do montażu



UWAGA !!
MONTOWANIE USZKODZONYCH ELEMENTÓW
POWODUJE UTRATĘ GWARANCJI

Nr	Nazwa elementu	D[mm]	S[mm]	G[mm]	Ilość
1	Bok P/L	2018	635	16	2
2	Błat Górny	1400	650	16	1
3	Błat Dolny	1432	666	100	1
4	Przegroda	2018	500	16	1
5	Wieniec	765	500	16	1
6	Wieniec	588	500	16	2
7	Przegroda Mała	500	398	16	1
8	Półka	765	500	16	1
9	Półka	588	500	16	2
10	Listwa P/L	2018	100	115	2
11	Korona	1475	85	22	1
12	Korona P/L	690	85	22	2
13	Bok Szuflady	400	160	16	4
14	Tył Szuflady	432	160	16	2
15	Przód Szuflady	498	190	16	2
16	Kapak	2045	608	2,5	1
17	Kapak	2045	393	2,5	2
18	Kapak Szuflady	460	405	2,5	2
19	Drzwi	2005	620	32	2

W przypadku reklamacji proszę podać numer pakowacza znajdujący się na kartonie.

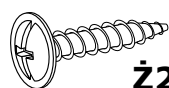

Ż2 - 4 St.
3,5x16 mm



SZ - 2x2,05m.



X1 - 40 St.



X2 - 8 St.

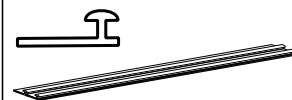

C - 4 St.

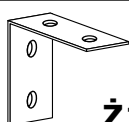

Ż1 - 2 St.



D - 4 St.



I1 - 4 St.

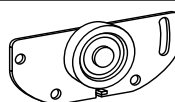

I2 - 4 St.



O - 2 St.

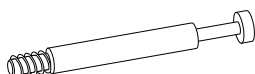

K1 - 10 St.



U2 - 2 St.

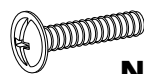

N2 - 4 St.
4x25 mm



U1 - 2 St.

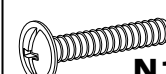

N1 - 4 St.
4x27 mm

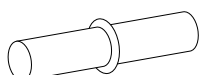

F - 12 St.

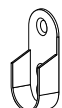

R - 2 St.

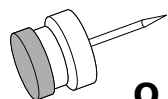

Q - 6 St.



M - 30 St.
3x30 mm

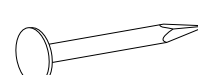

E - 100 St.



Z - 1 St.

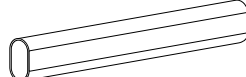

W - 1 St.

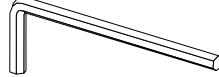

Ł - 1 St.

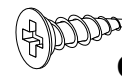

G - 50 St.
3,5x16 mm



L - 40 St.

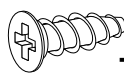

J - 16 St.
5x13 mm

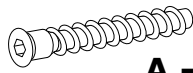

A - 8 St.
7x50 mm

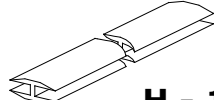

H - 1 St.

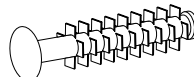

P - 8 St.

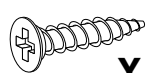

Y - 11 St.
4x20 mm

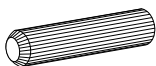

B - 40 St.
8x35 mm

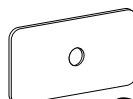

S - 10 St.

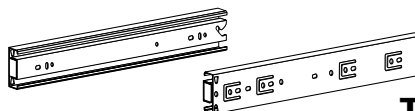

T - 2 Kpl.

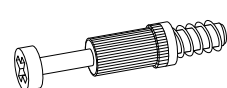

K - 26 St.

I

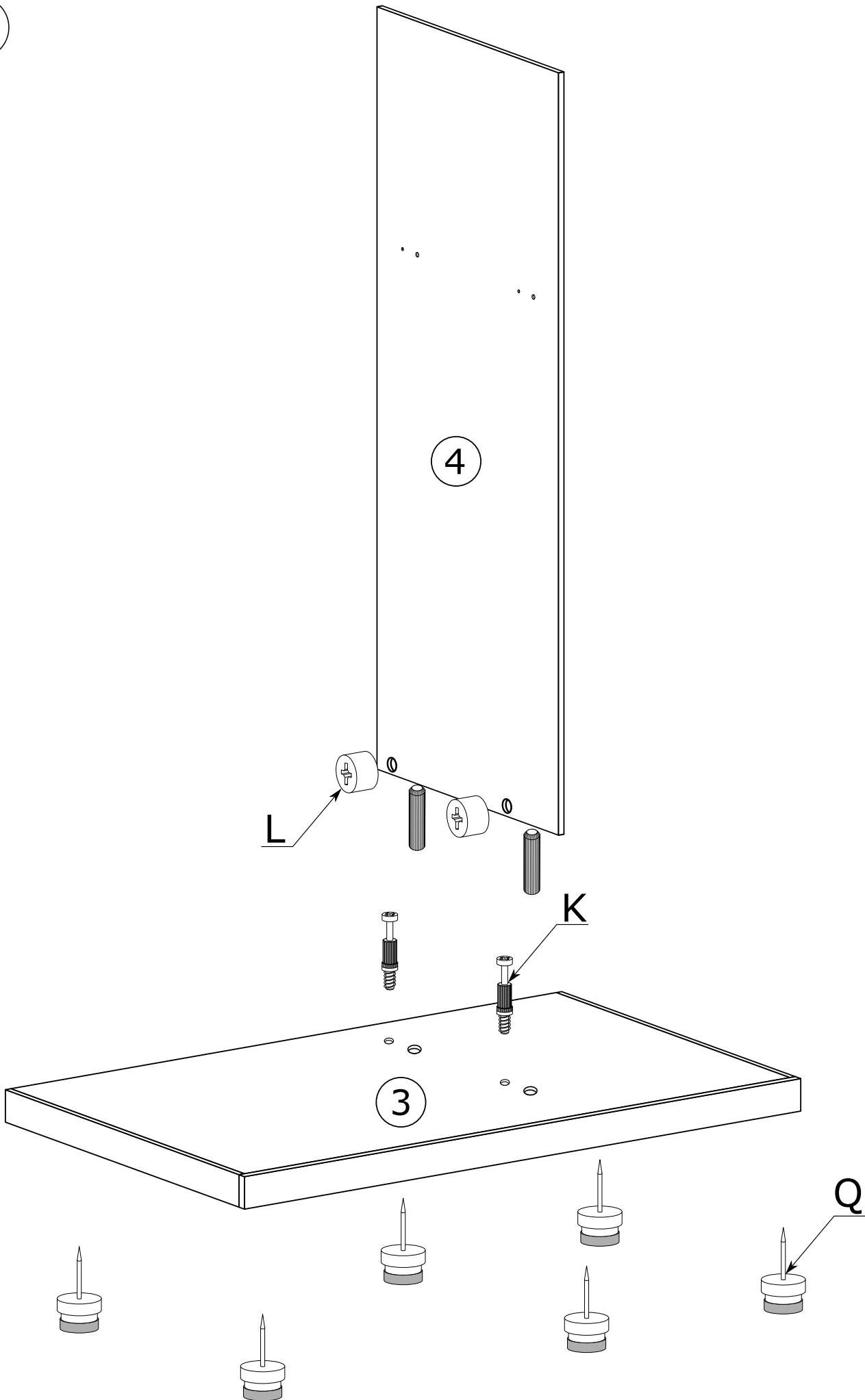

II

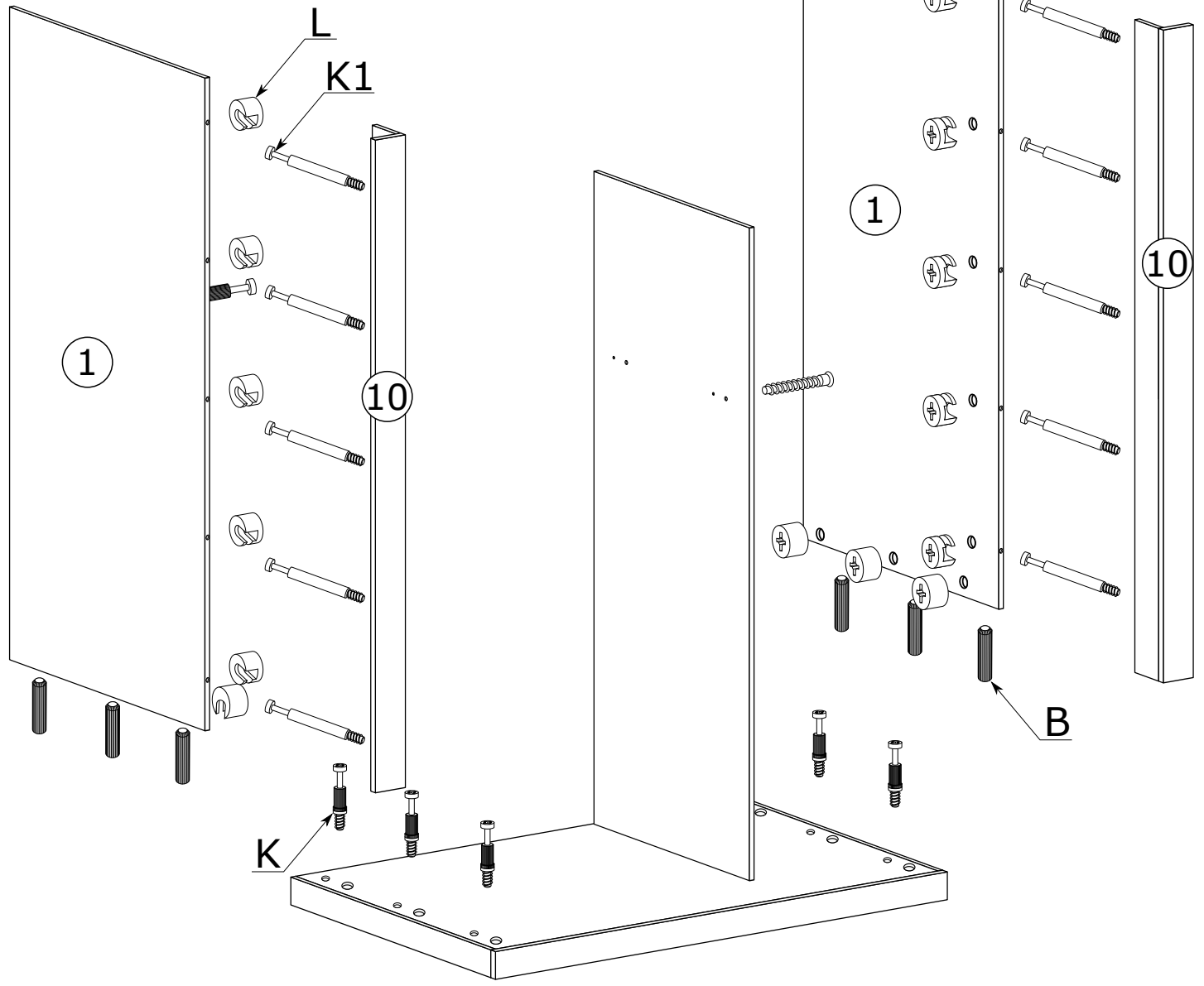
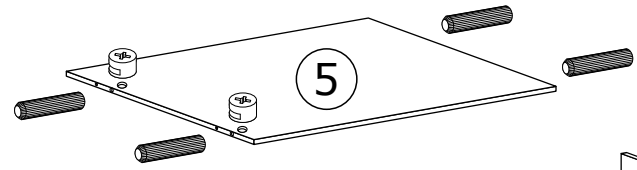

III

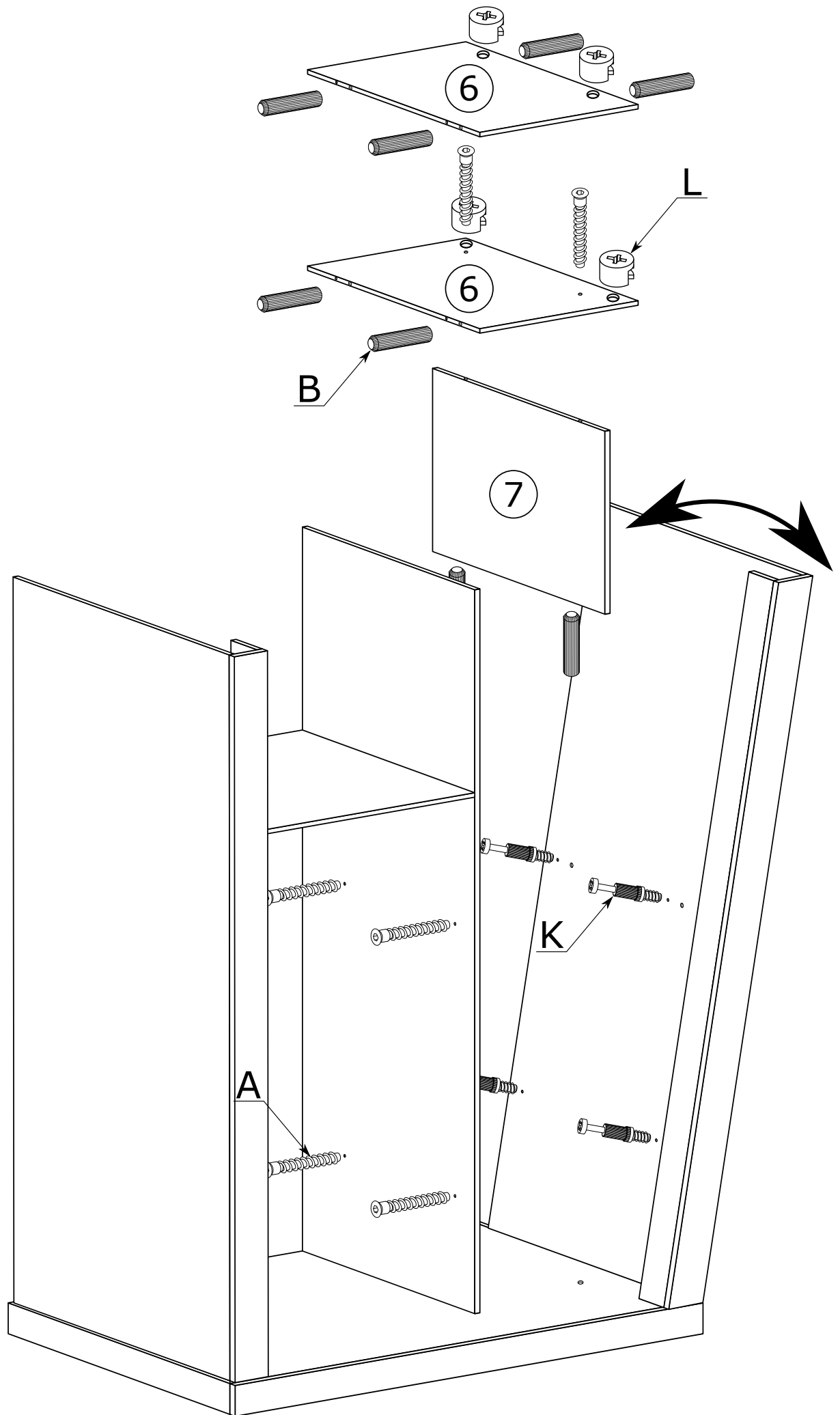

IV

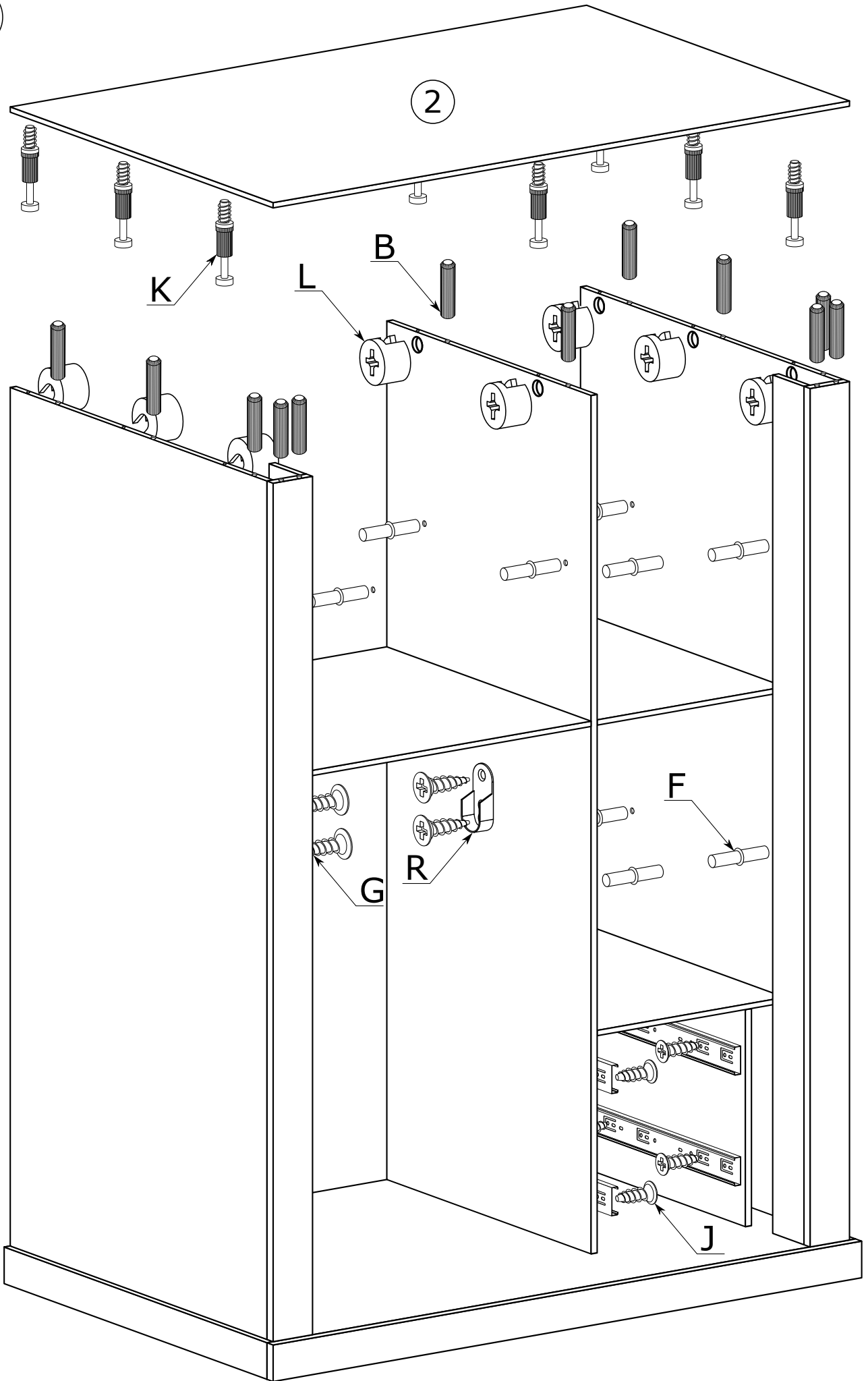

V

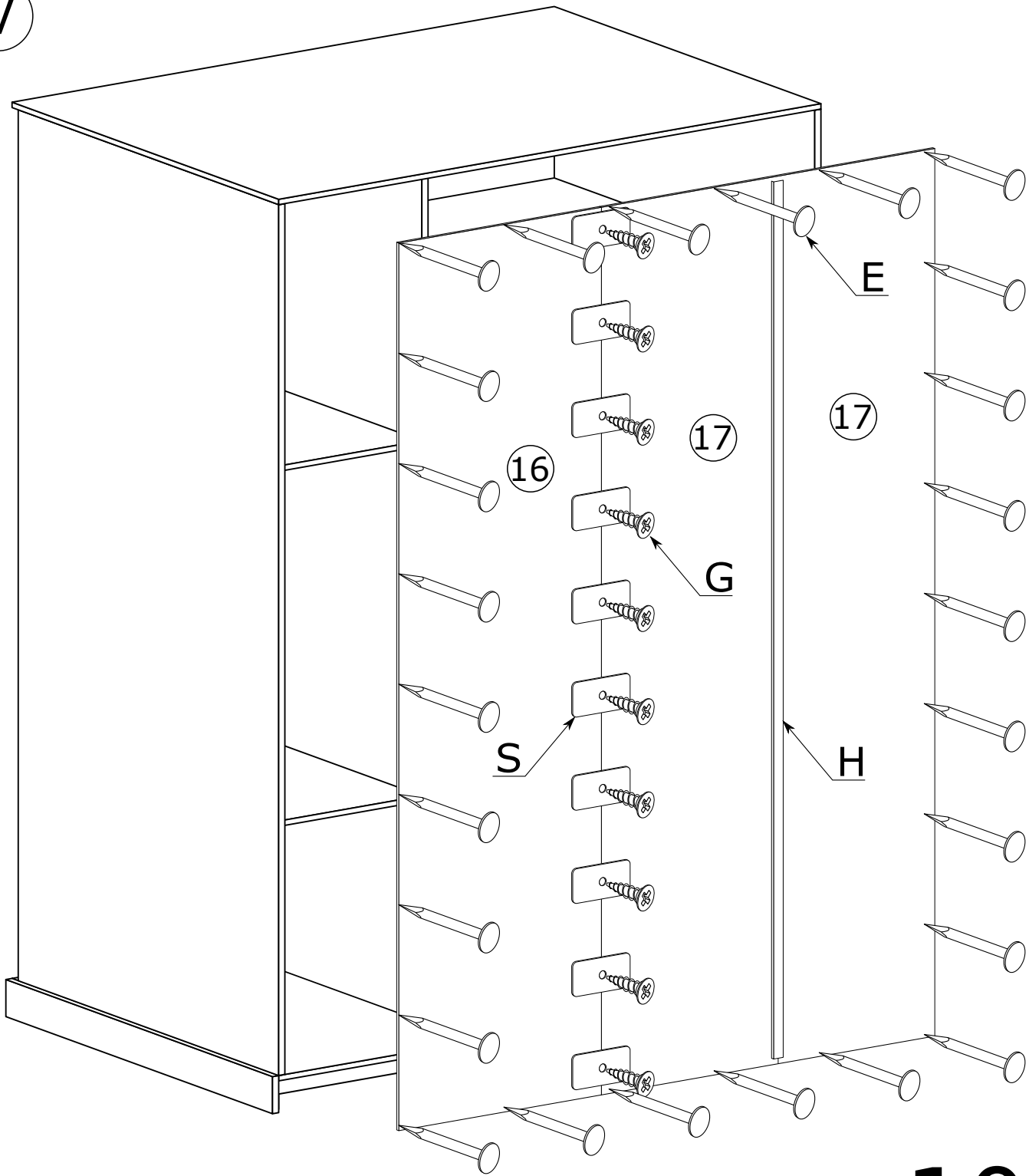

x100

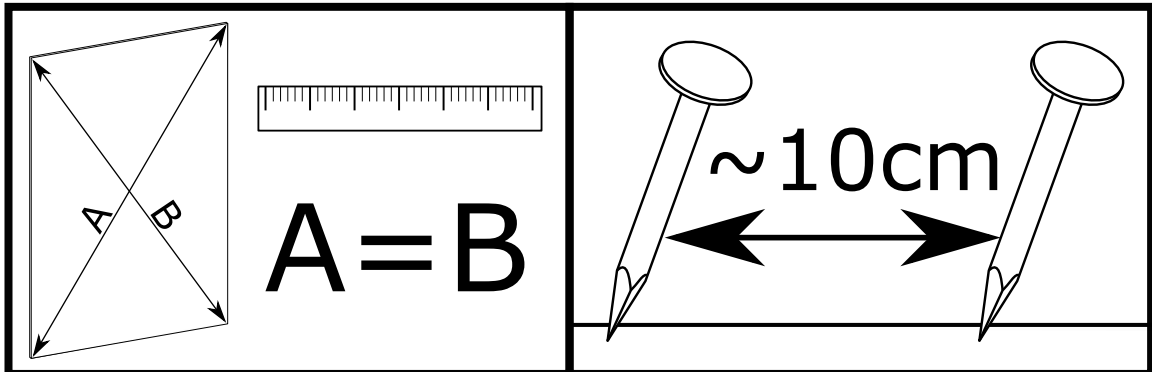

VIII

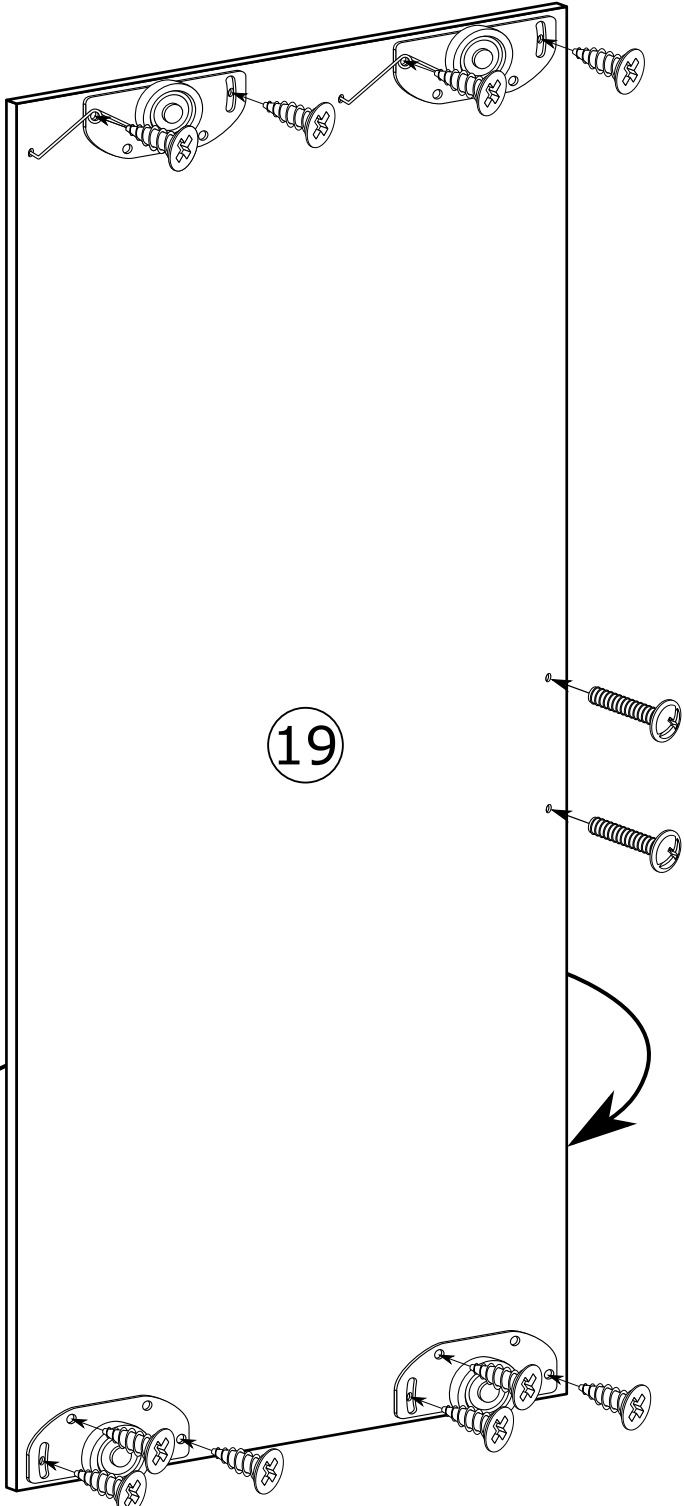
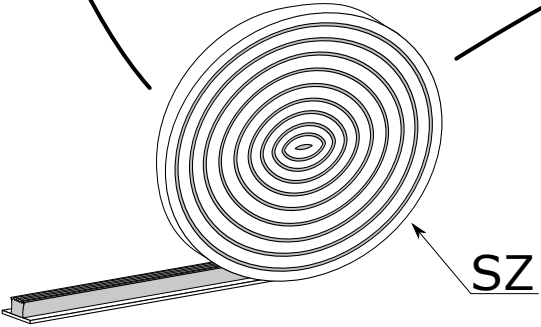
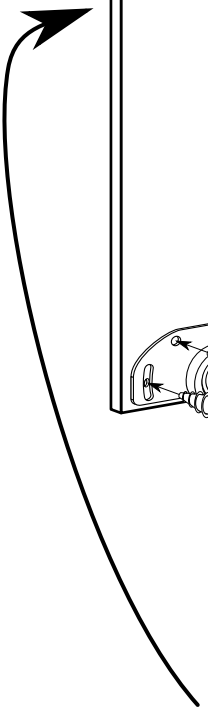
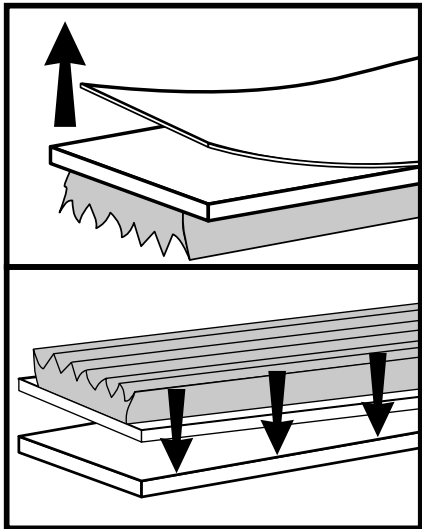
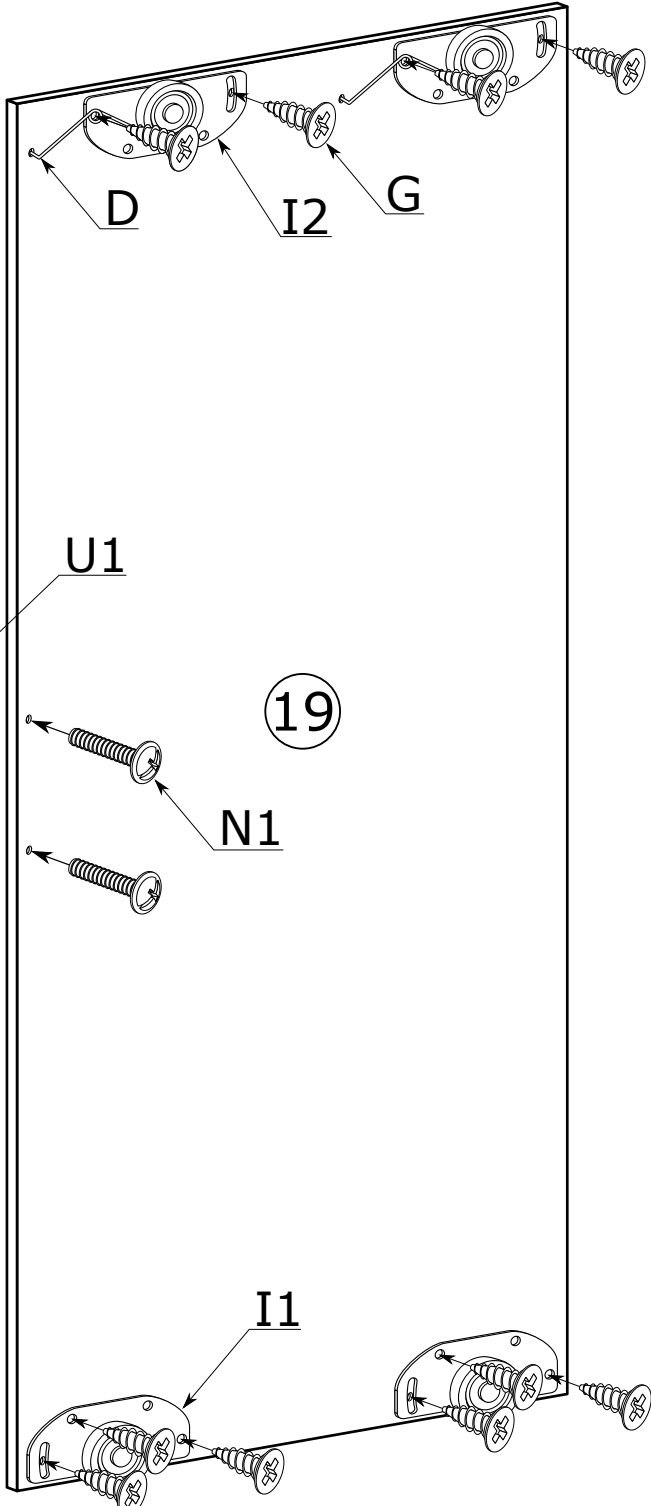

19

19

IX

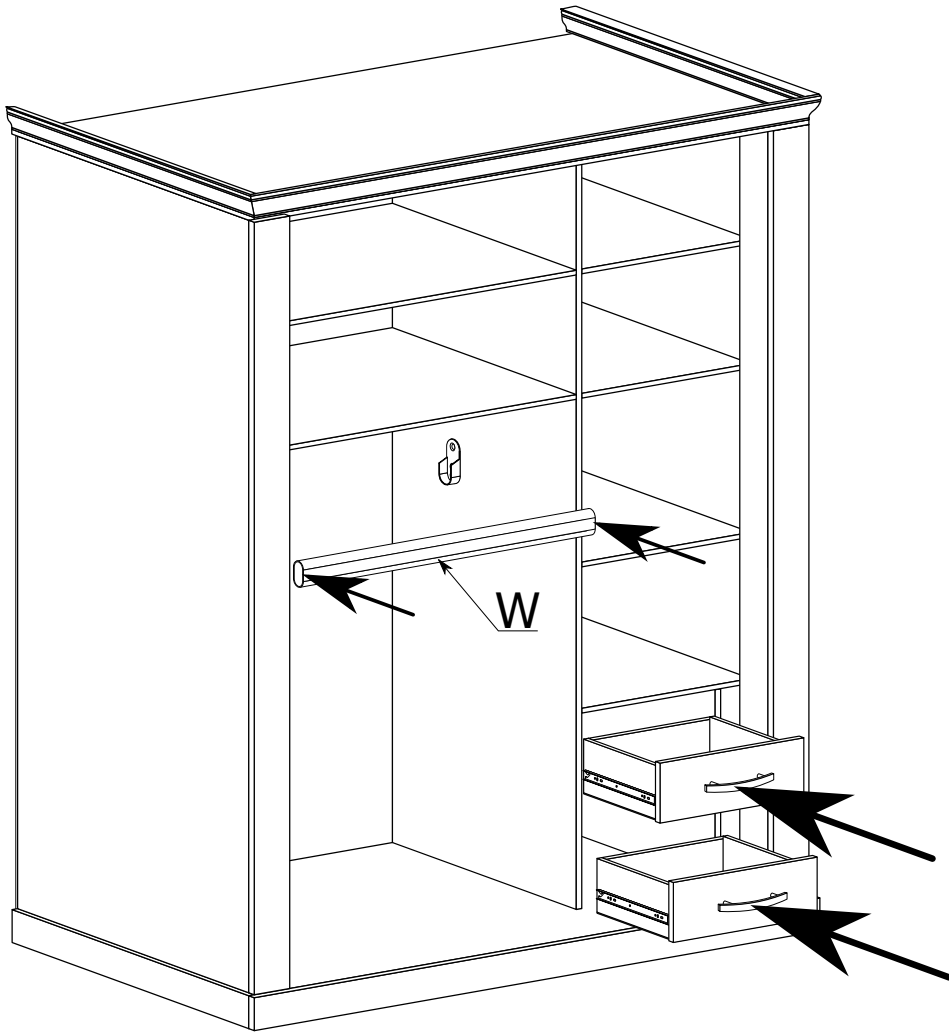

X

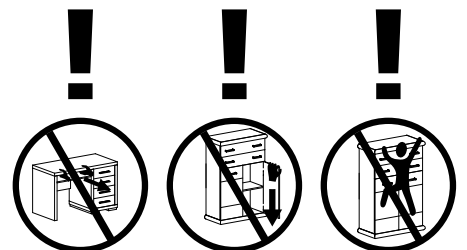
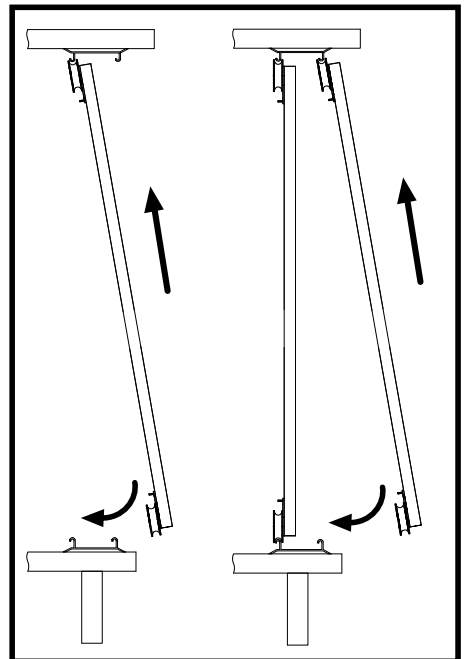
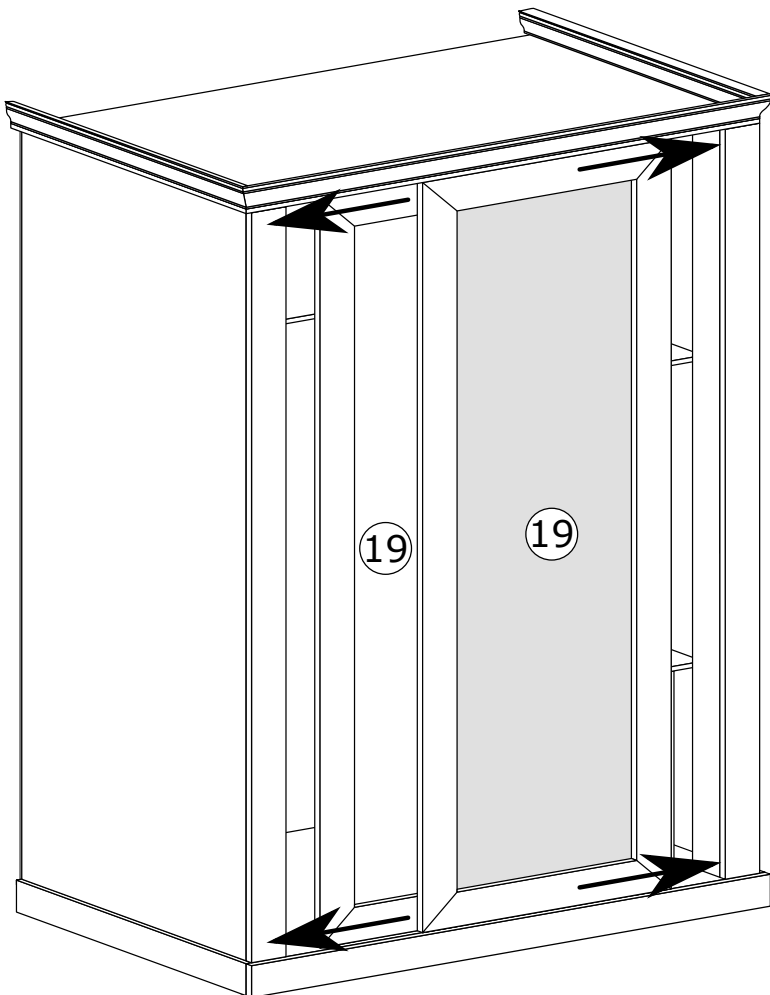

MONTAŻ/DEMONTAŻ PROWADNIC

1



2

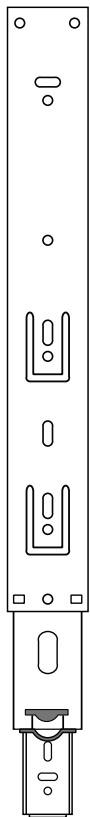

3

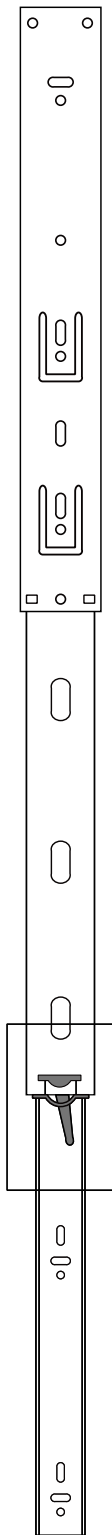

4

