

# PARIS 12

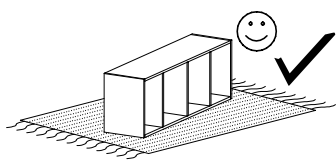

Narzędzia potrzebne do montażu

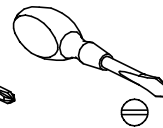
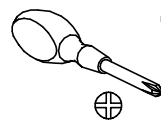
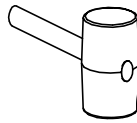
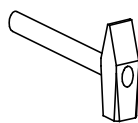

## **UWAGA !!!**

MONTOWANIE USZKODZONYCH  
ELEMENTÓW POWODUJE UTRATĘ  
GWARANCJI

Nr	D[mm]	S[mm]	G[mm]	Ilość
1	1200	320	16	1
2	1200	160	48	1

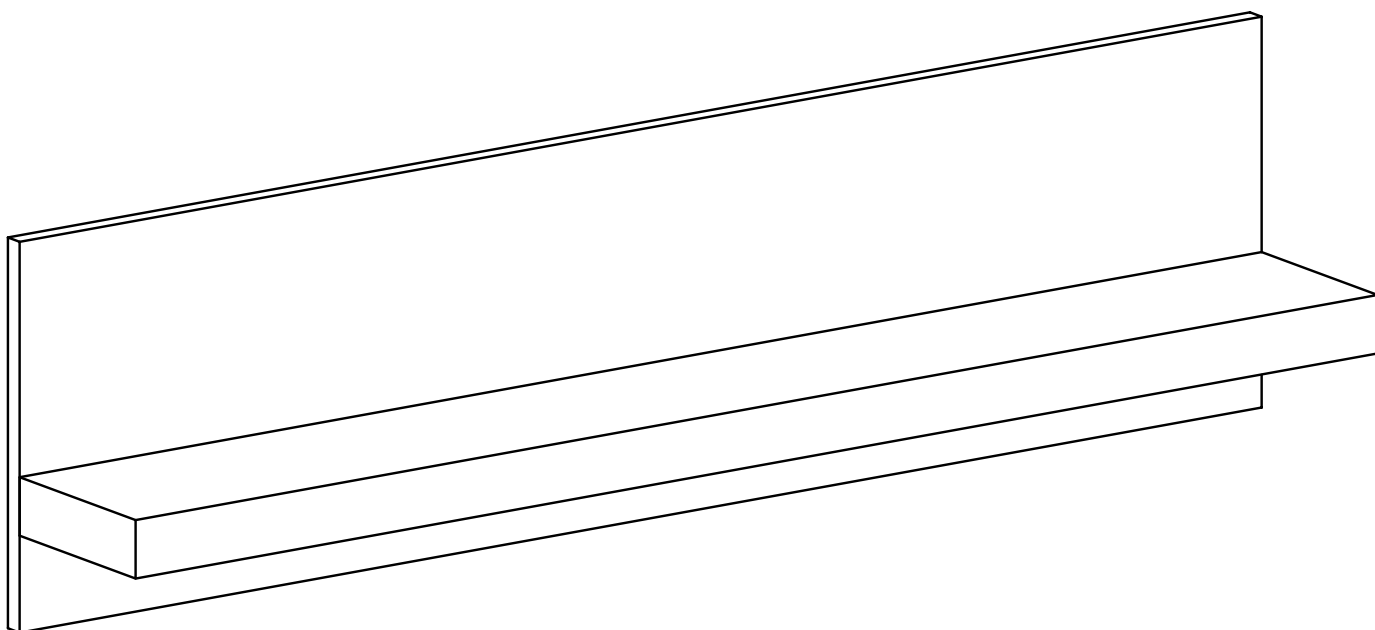

W przypadku reklamacji proszę podać numer pakowacza znajdujący się na kartonie.



**Z - 1 St.**

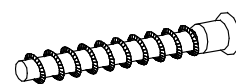

**A - 4 St.**

I

