

PARIS 8

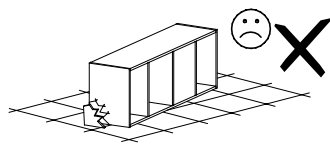

Narzędzia potrzebne do montażu

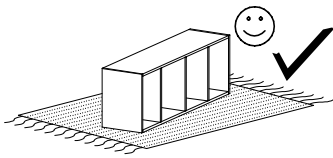
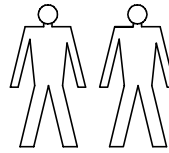
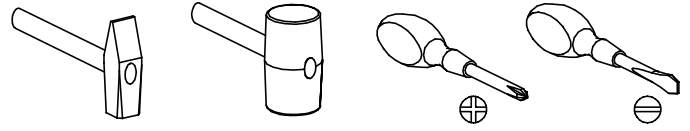

UWAGA !!!

MONTOWANIE USZKODZONYCH
ELEMENTÓW POWODUJE UTRATĘ
GWARANCJI

Nr	D[mm]	S[mm]	G[mm]	Ilość
1	1710	436	48	1
2	1710	436	48	1
3	780	435	48	1
4	780	388	16	1
5	780	388	16	1
6	780	435	48	1
7	393	312	16	2
8	852	388	16	1
9	1700	834	2,5	1
10	430	580	16	1
11	822	355	2,5	1
12	862	190	16	1
13	350	165	16	1
14	350	165	16	1
15	792	165	16	1
16	772	368	16	1
17	772	368	16	1
18	430	580	16	1

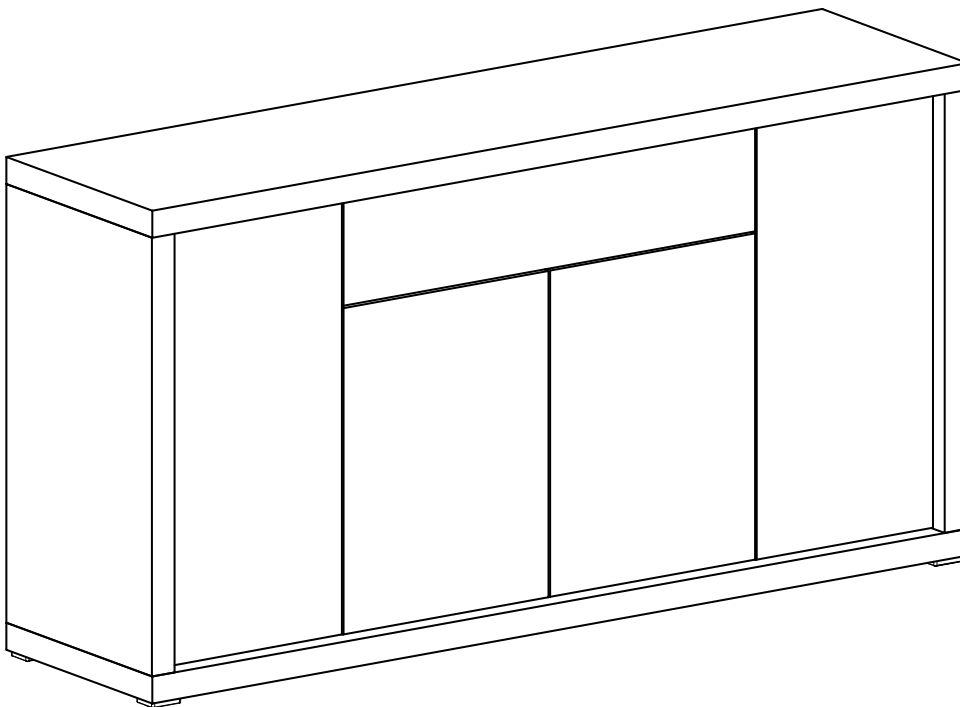

W przypadku reklamacji proszę podać numer pakowacza znajdujący się na kartonie.

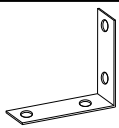

Y - 2 St.

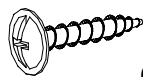

Q - 4 St.
3,5x16 mm



J - 8 St.
5x13 mm

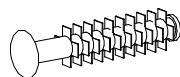

S - 4 St.

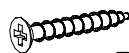

R - 12 St.
3,5x25 mm



Z - 1 St.

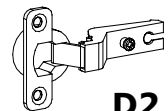

D2 - 4 St.

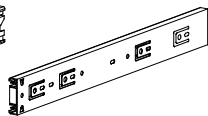
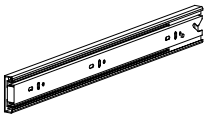

T - 1 Kpl.

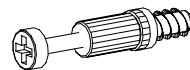

K - 16 St.



G - 24 St.
3,5x16 mm



L - 16 St.

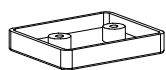

A - 6 St.



N - 15 St.
3x30 mm

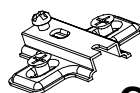

C - 8 St.

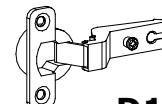

D1 - 4 St.



P - 8 St.



E - 80 St.



B - 20 St.

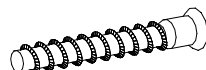

W - 4 St.

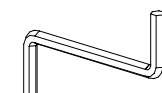

Z - 1 St.

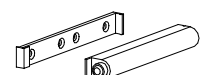

F - 4 St.

I

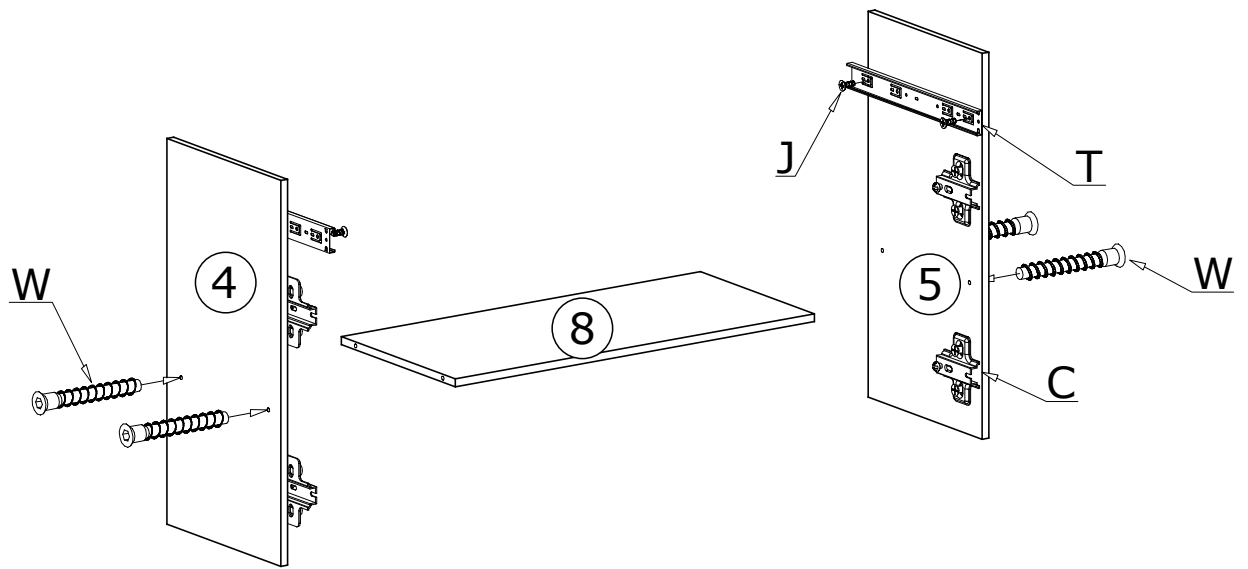

II

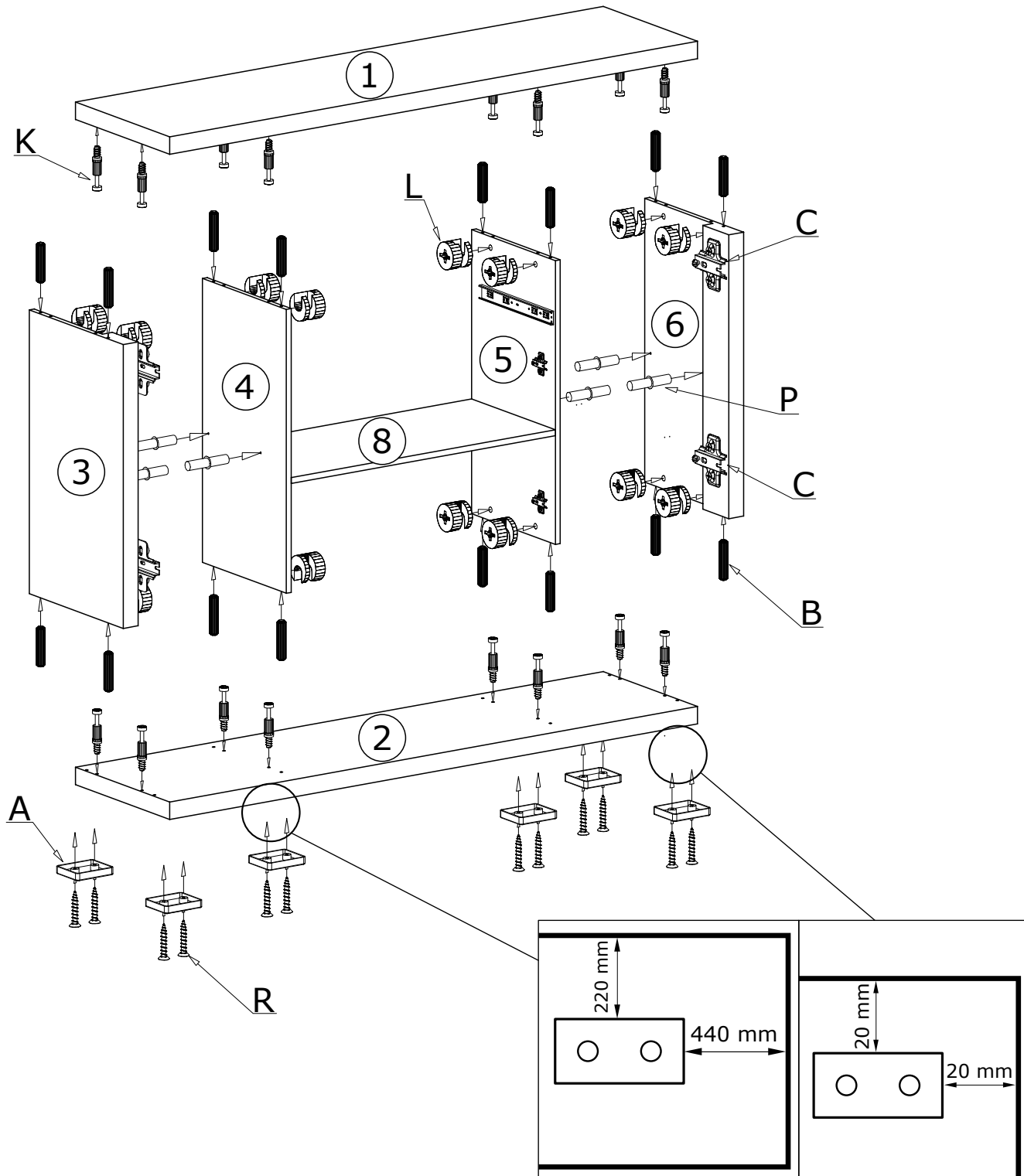

III

80X 

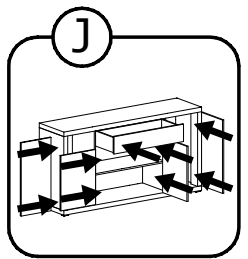
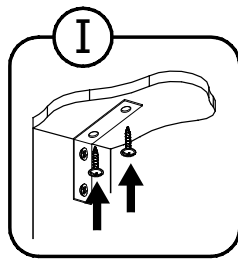
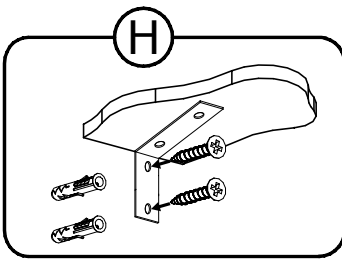
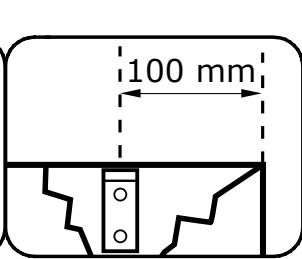
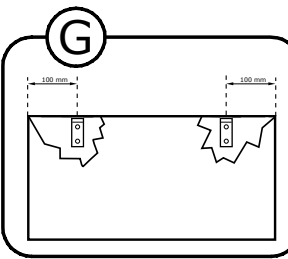
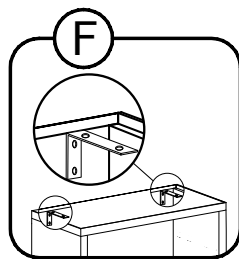
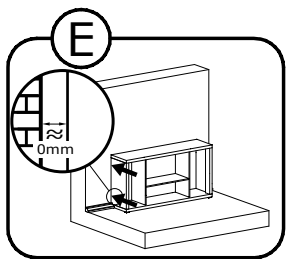
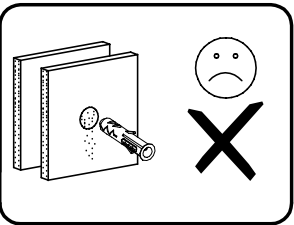
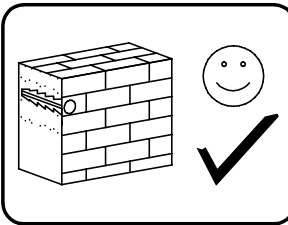
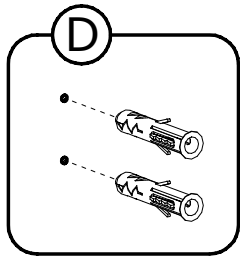
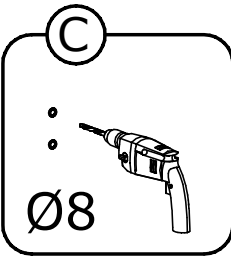
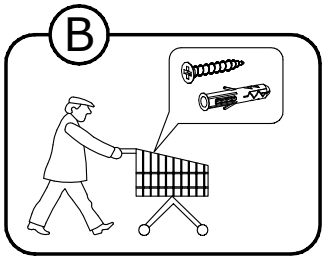
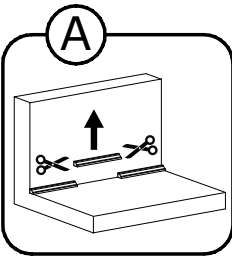
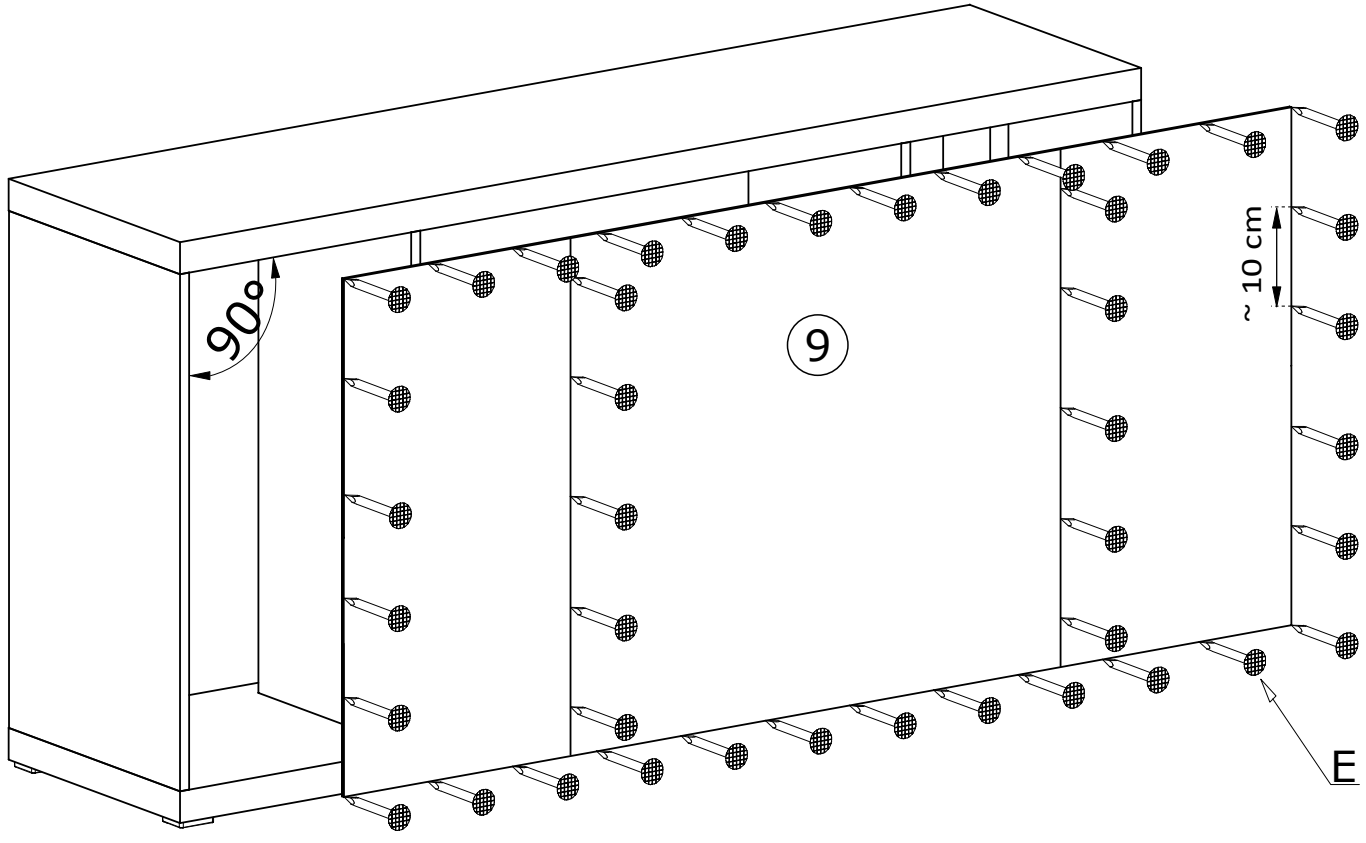

IV

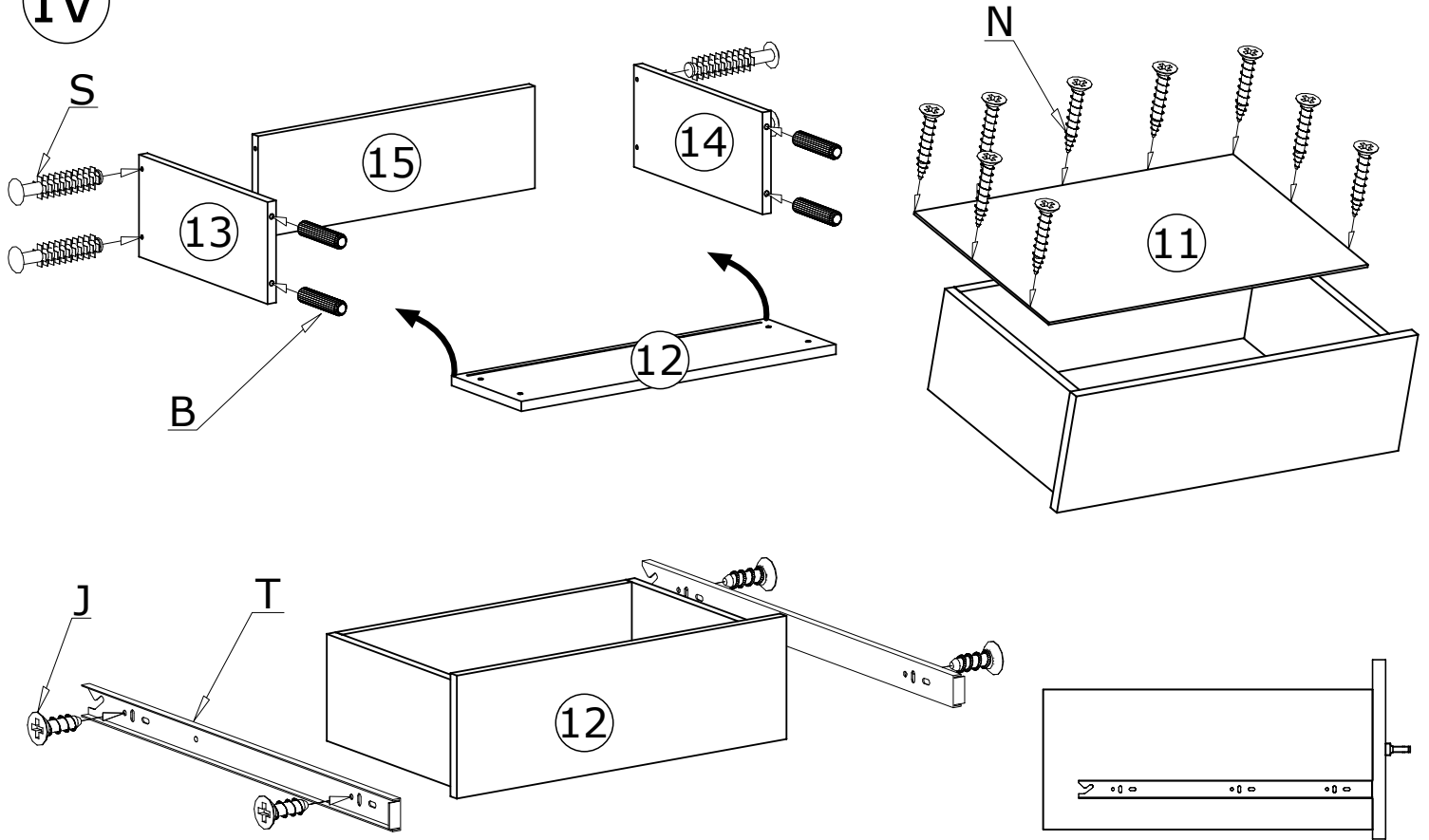

V

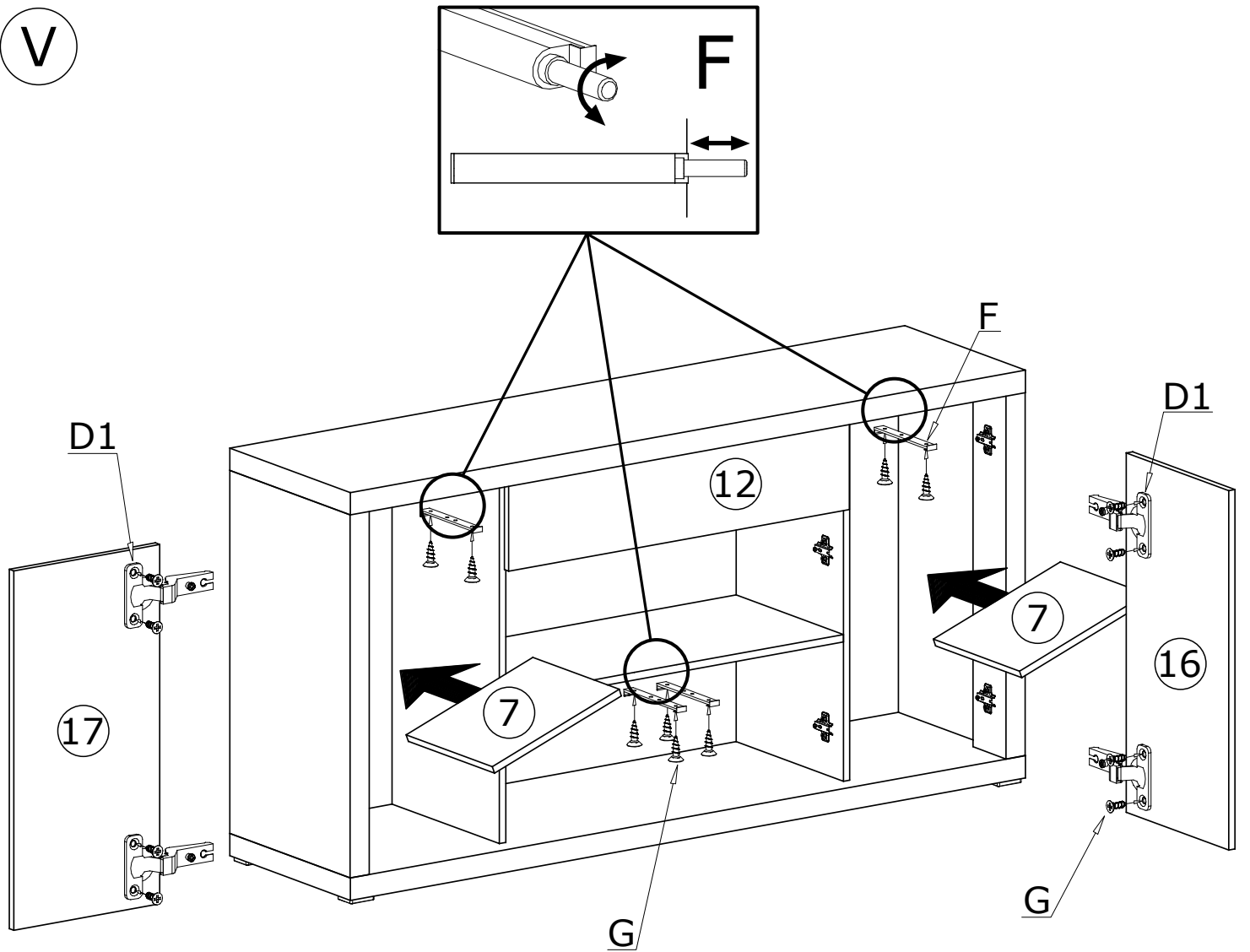

VI

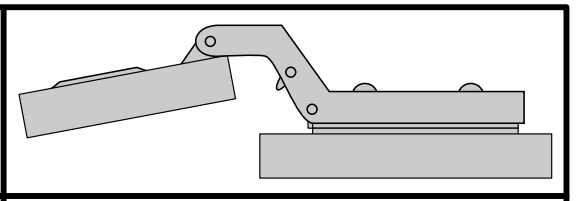
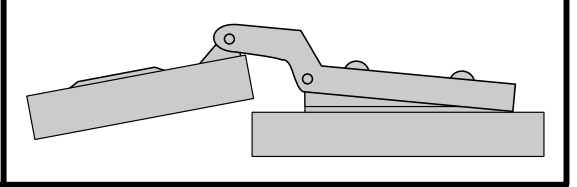
D1	
D2	

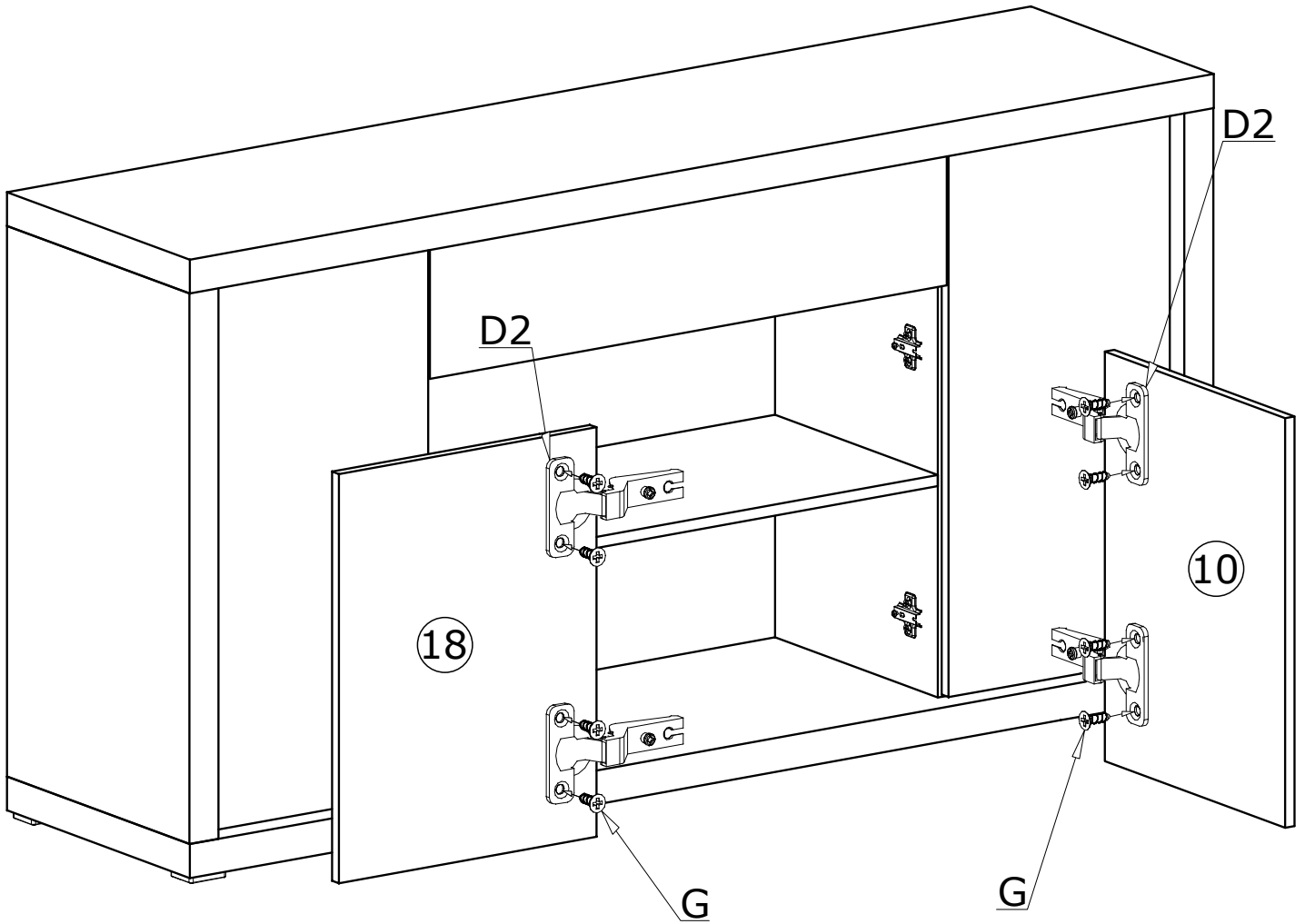

MONTAŻ/DEMONTAŻ PROWADNIC

1

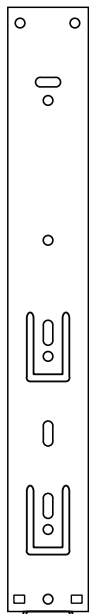

2

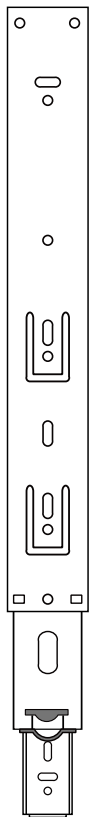

3

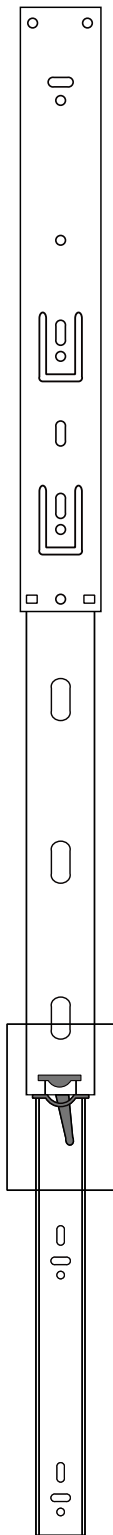

4

