

NATURAL 9

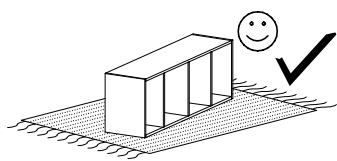

Narzędzia potrzebne do montażu



UWAGA !!!

MONTOWANIE USZKODZONYCH
ELEMENTÓW POWODUJE UTRATĘ
GWARANCJI

UWAGA !!!

Mebel zawiera
elementy drewniane

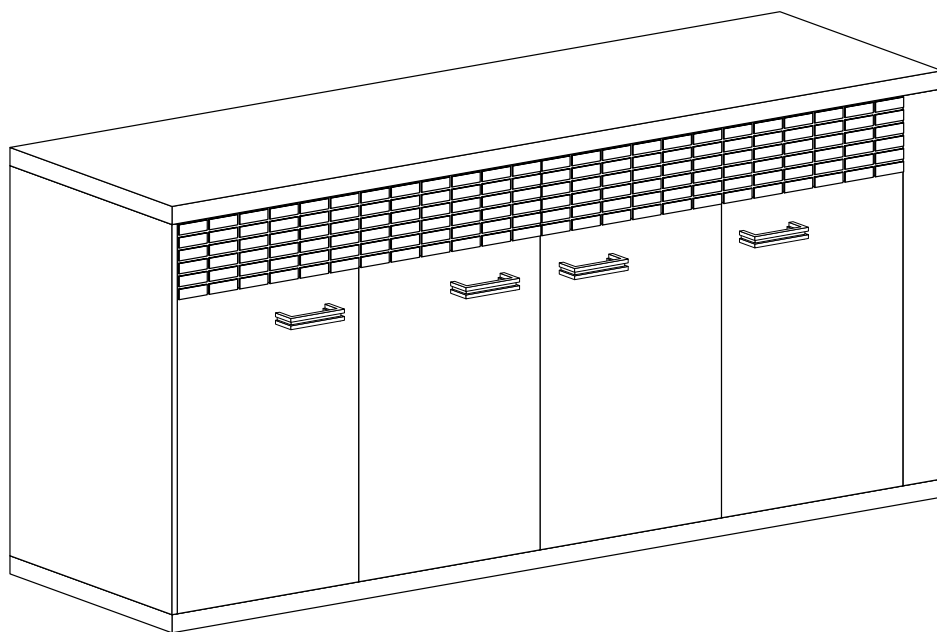

Nr	D[mm]	S[mm]	G[mm]	Ilość
1	885	405	16	1
2	885	389	16	1
3	1910	406	48	1
4	1910	406	48	1
5	1878	389	16	1
6	673	389	16	2
7	673	389	16	1
8	368	197	16	1
9	389	197	16	1
10	885	100	16	1
11	440	389	16	1
12	432	389	16	2
13	525	389	16	1
14	1902	690	2,5	1
15	1902	247	2,5	1
16	350	165	16	4
17	831	165	16	2
18	892	190	35	2
19	858	345	2,5	2
20	685	445	16	2
21	685	445	16	2

W przypadku reklamacji proszę podać numer pakowacza znajdujący się na kartonie.



A - 4 St.

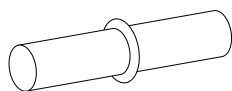

B - 8 St.

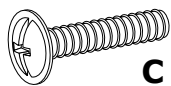

C - 8 St.
4x25 mm

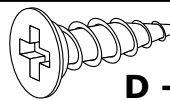

D - 36 St.
3,5x16 mm

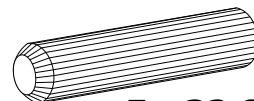

E - 32 St.

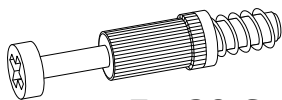

F - 29 St.



G - 29 St.



H - 16 St.



I - 90 St.

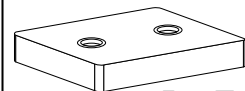

J - 7 St.

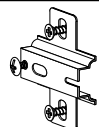

K - 4 St.

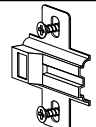

L - 4 St.

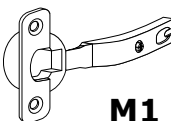

M1 - 1 St.

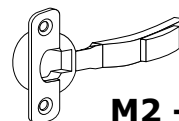

M2 - 1 St.

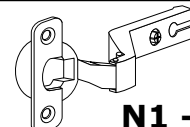

N1 - 1 St.

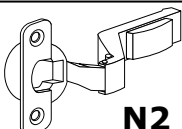

N2 - 1 St.

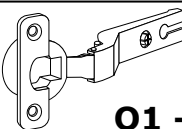

O1 - 2 St.

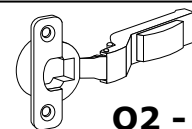

O2 - 2 St.

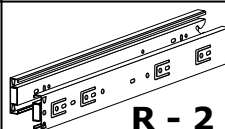

R - 2 Kpl.

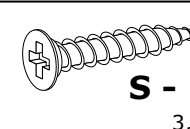

S - 14 St.
3,5x25 mm

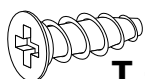

T - 16 St.
5x13 mm

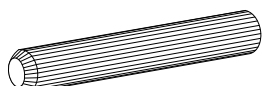

U - 2 St.

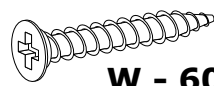

W - 60 St.
3x30 mm

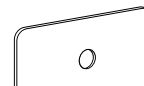

V - 20 St.



X - 1 St.

I

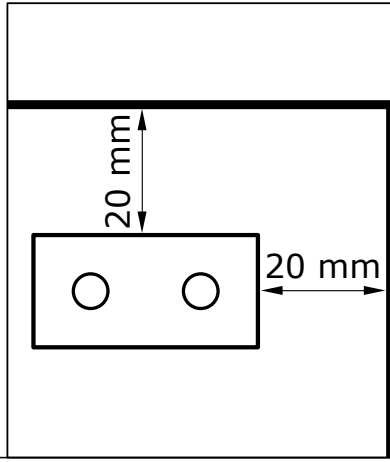
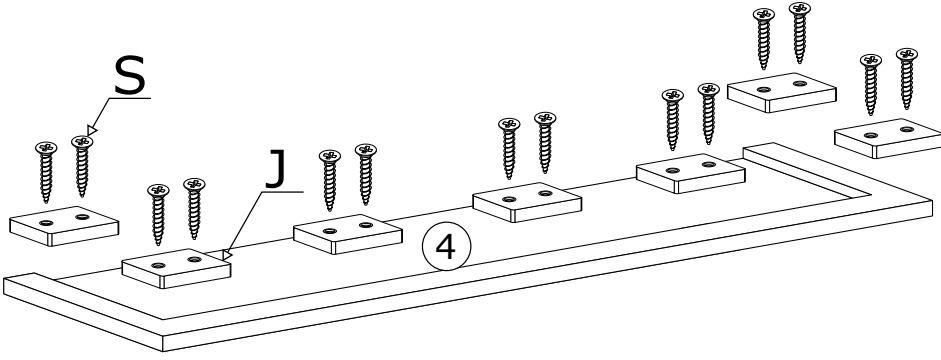

II

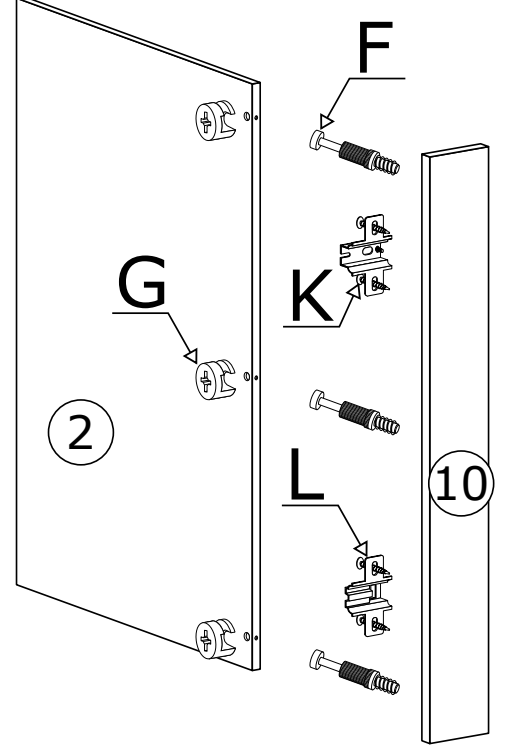

III

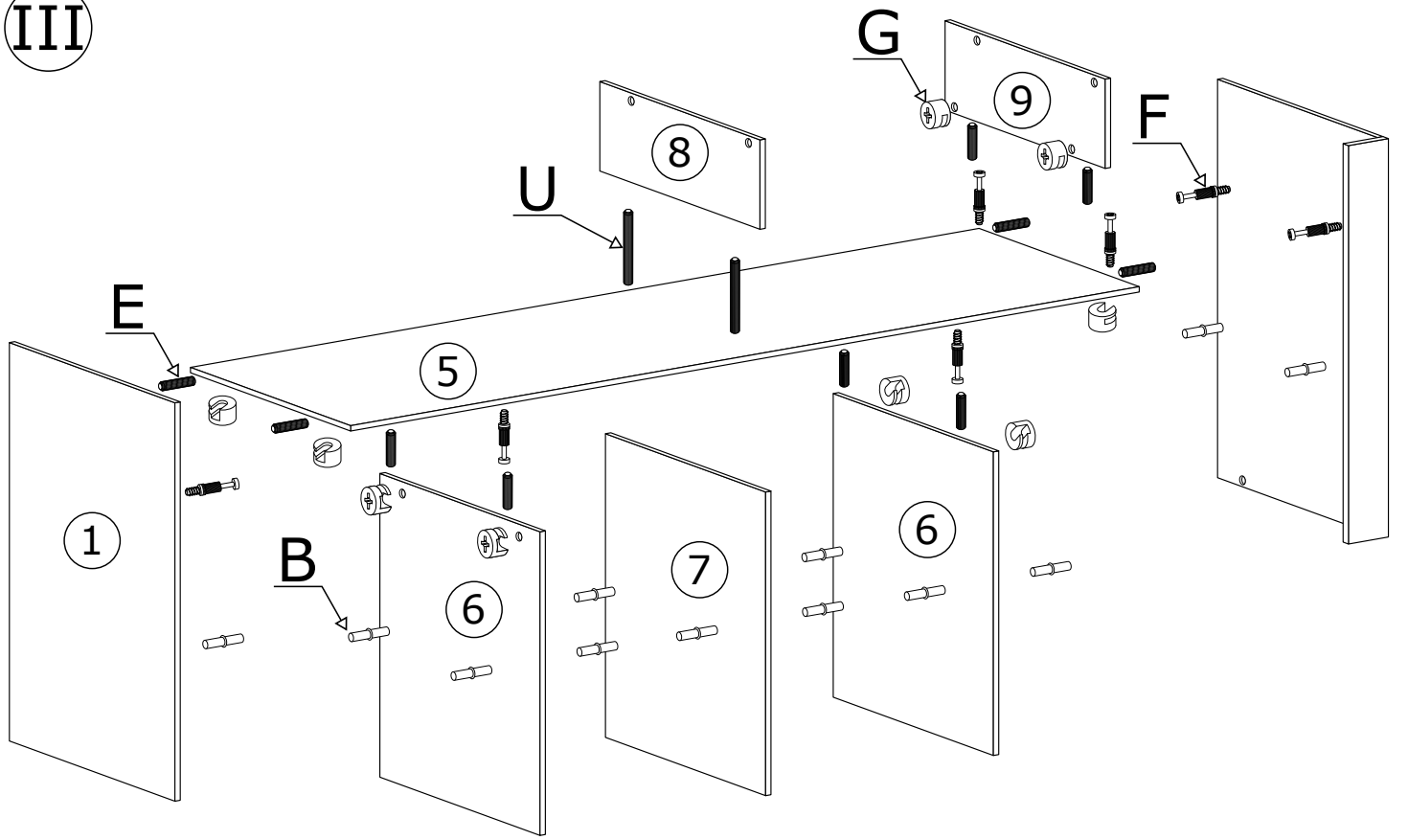

IV

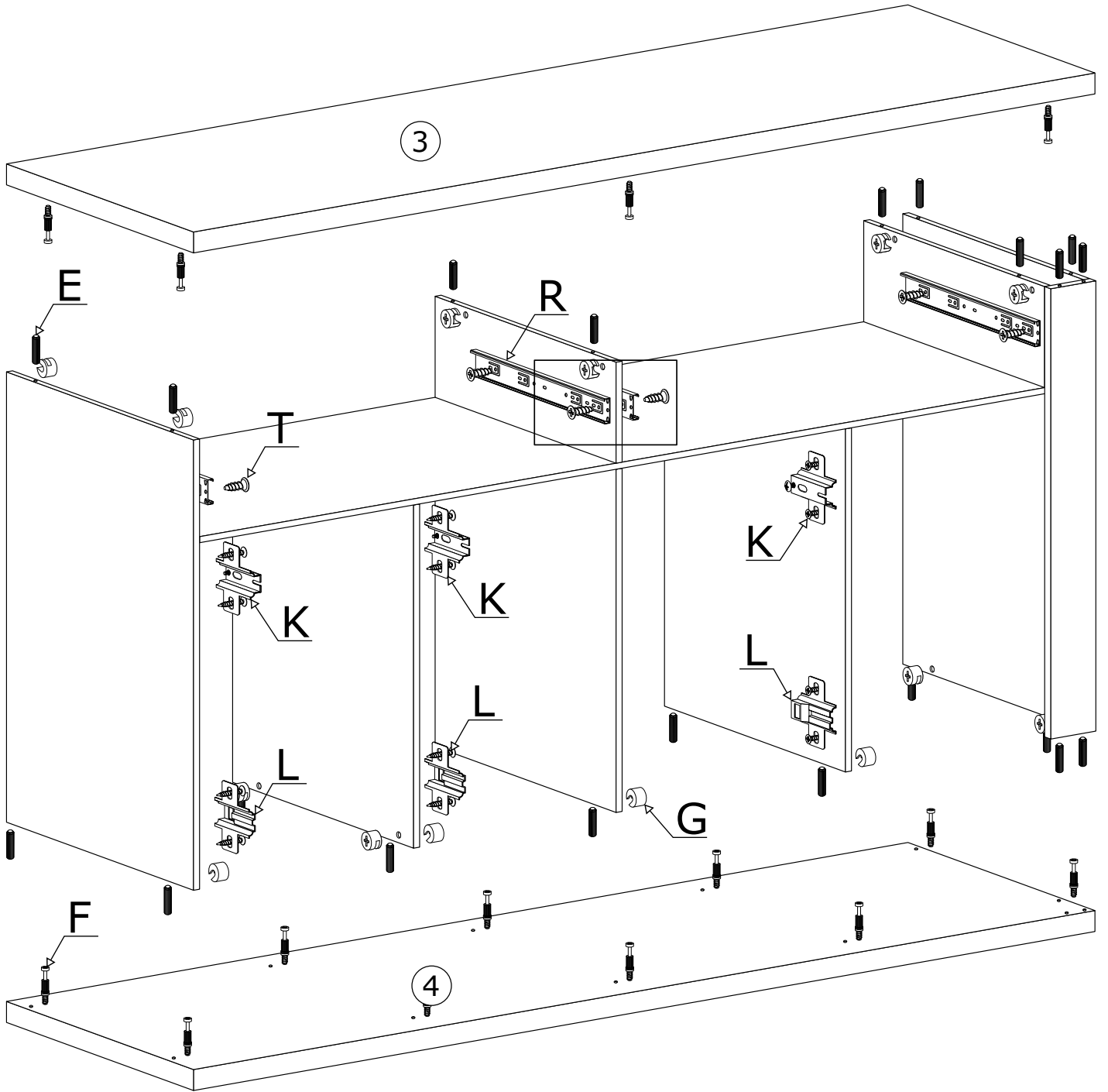
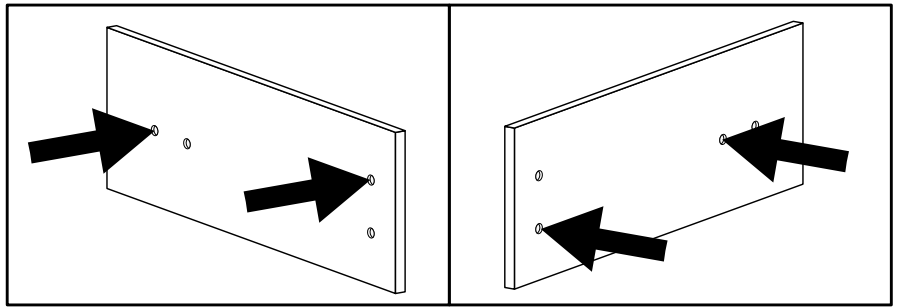

V

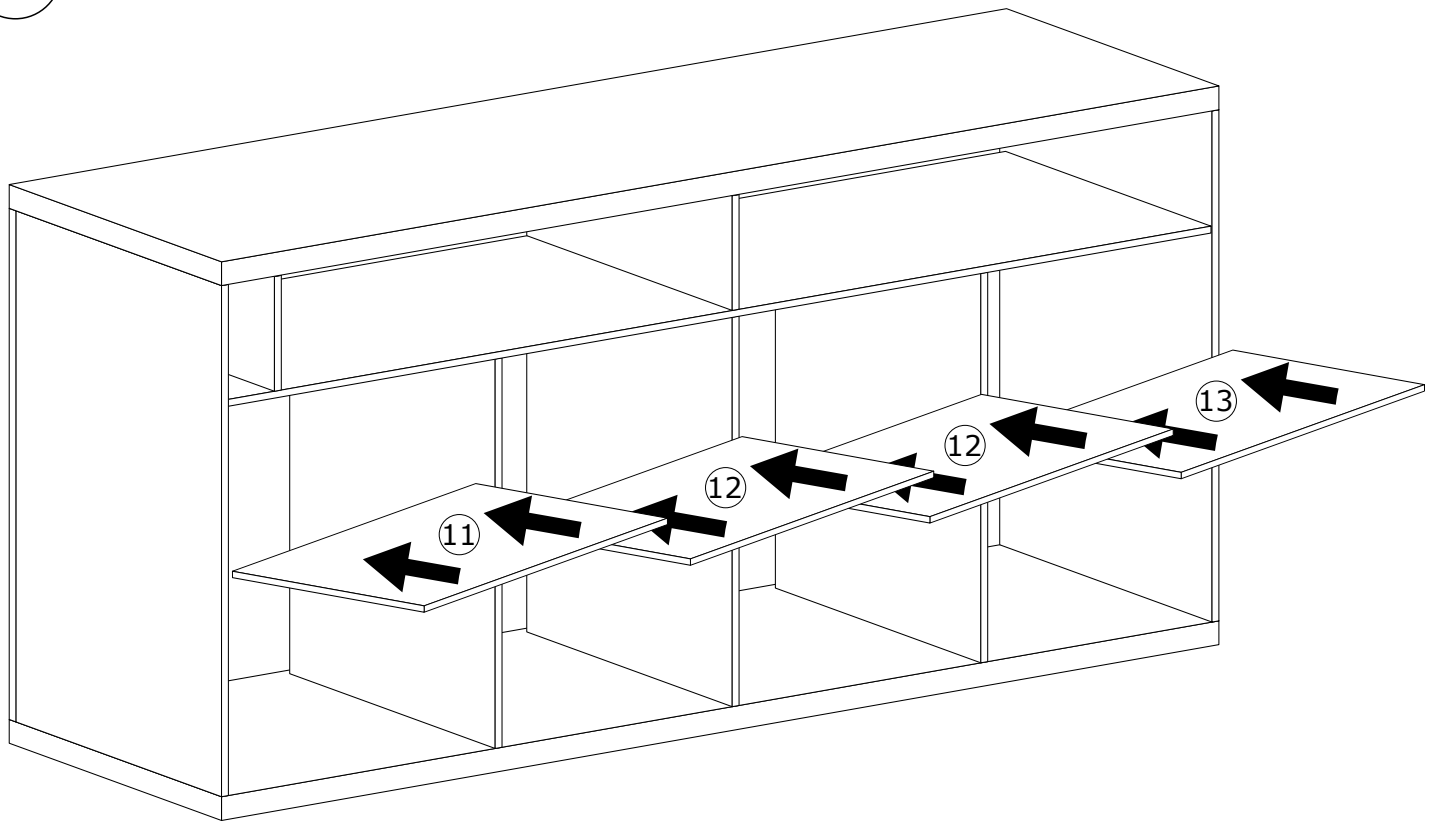

VI

x90

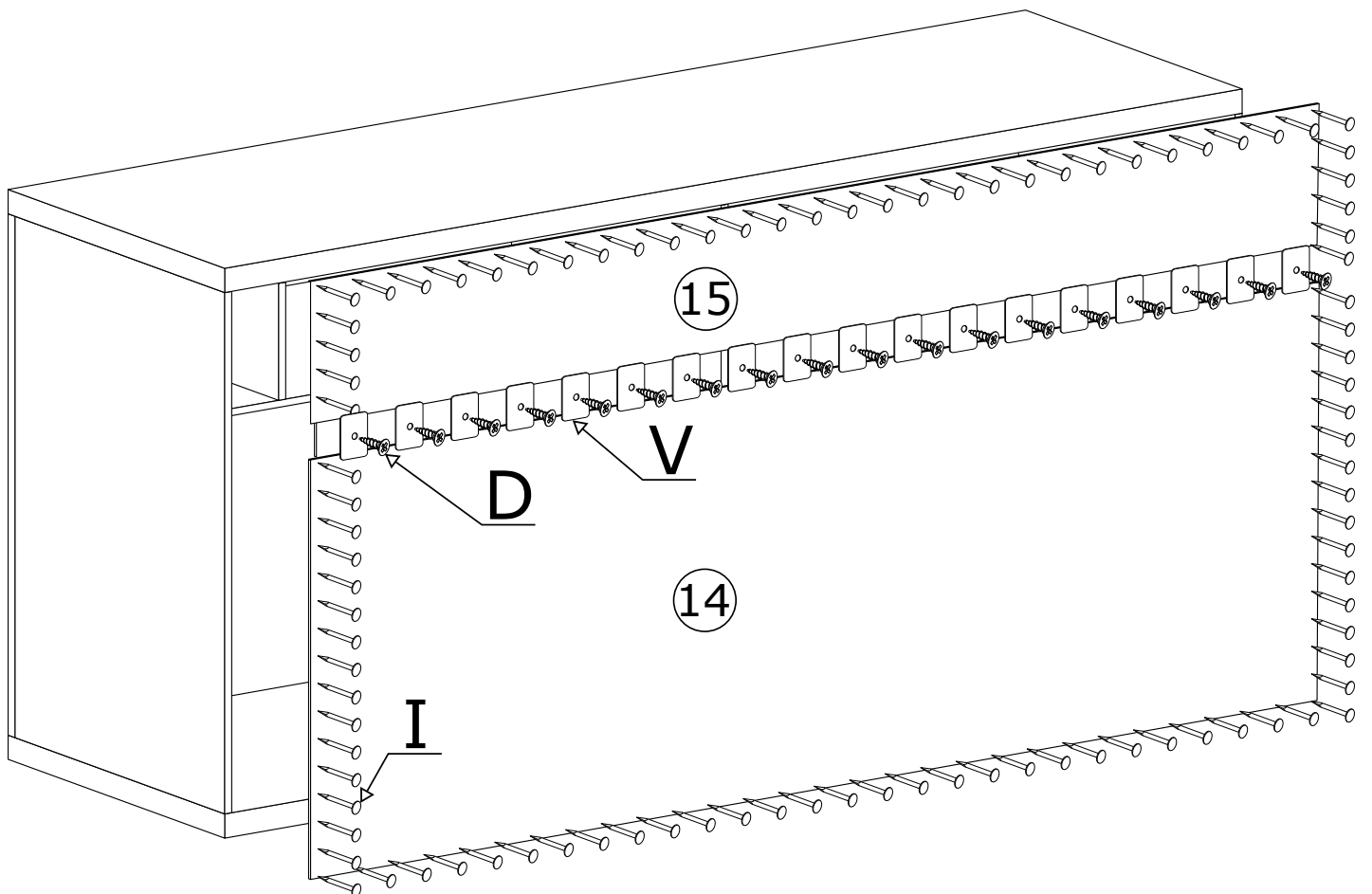

VII

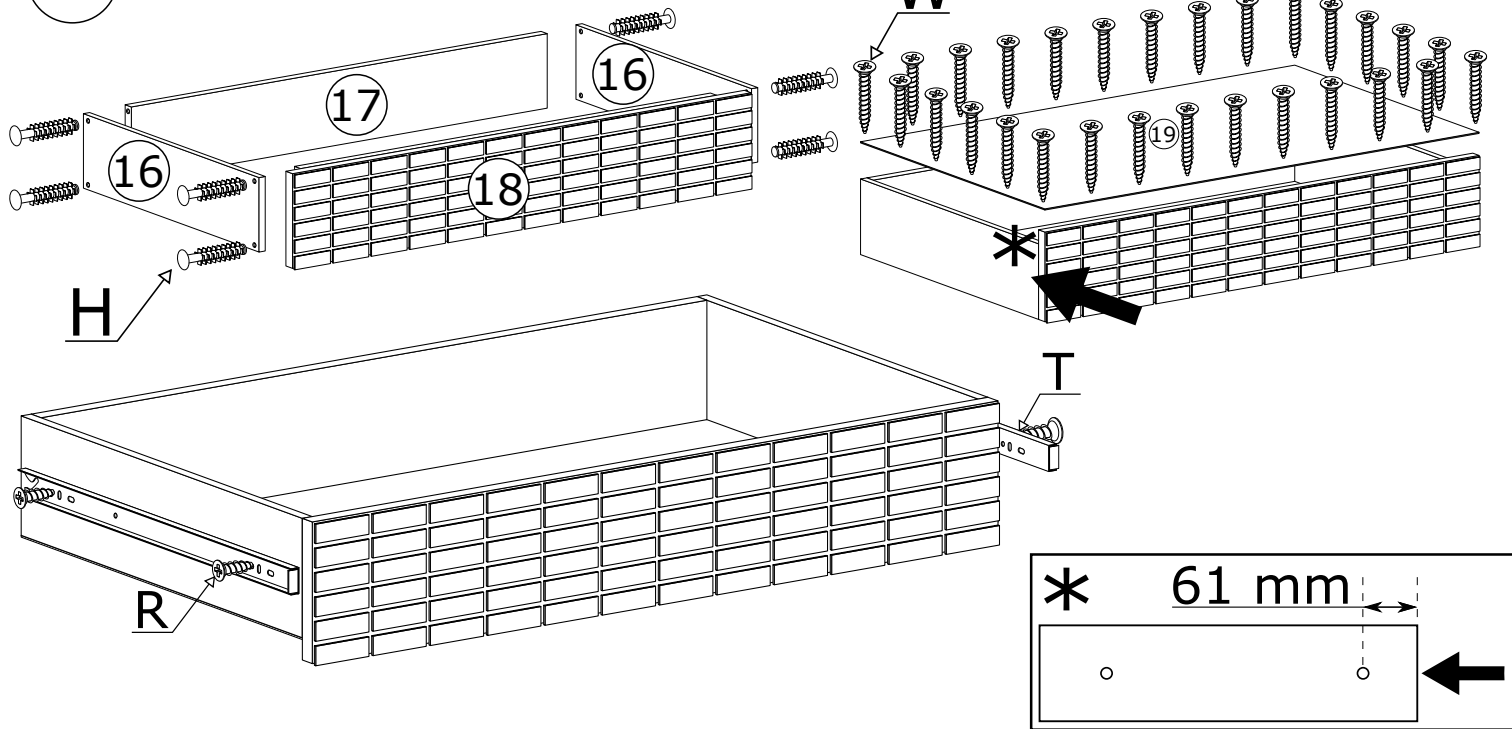

ELEMENT OZDOBNY WYKONANY RĘCZNIE Z PRAWDZIWEGODREWNA. ODCIEŃ DREWNA I OKŁAD SŁOI MOGĄ NIEZNACZNIE ODBIEGAĆ OD PREZENTOWANYCH NA ZDJĘCIACH KATALOGOWYCH.

VIII

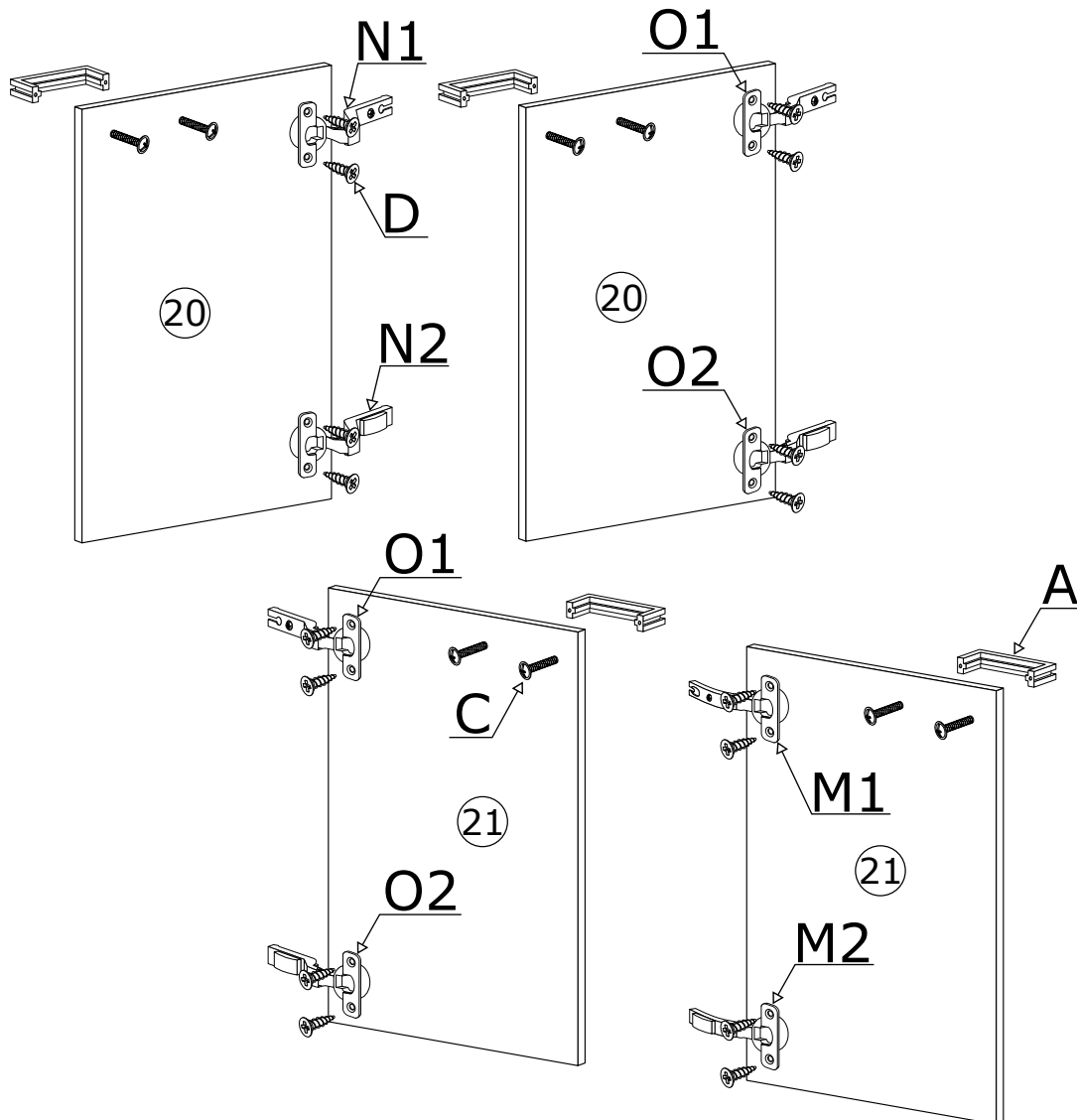

IX

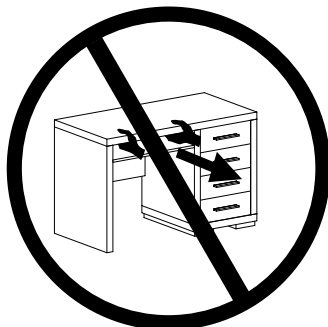
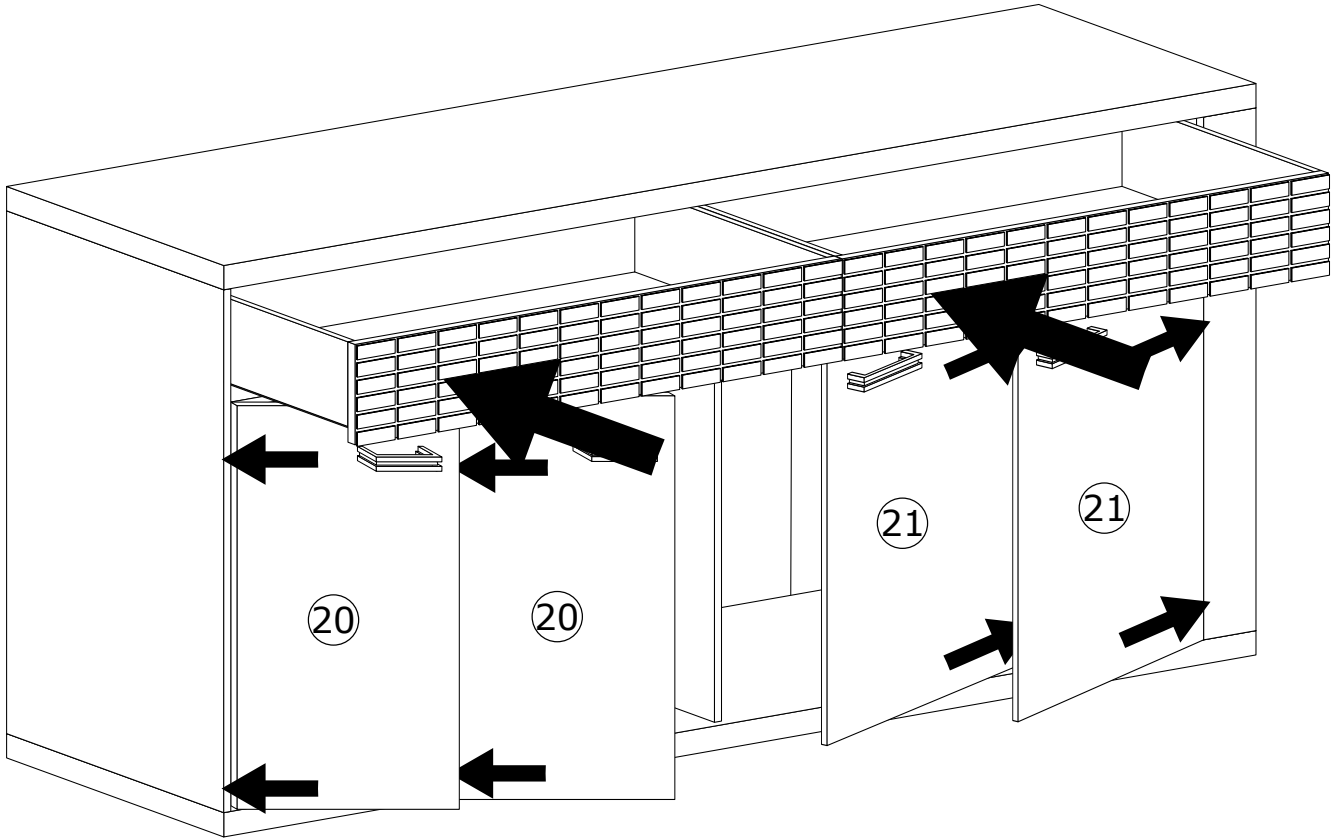

MONTAŻ/DEMONTAŻ PROWADNIC

1



2



3

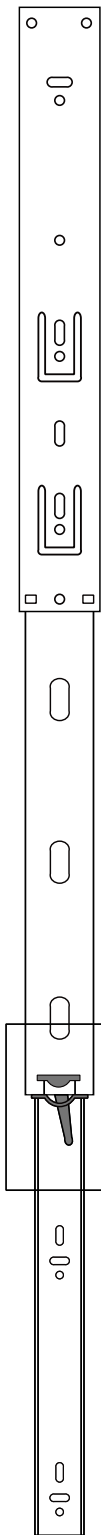

4

