

NATURAL 6

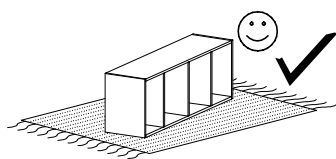

Narzędzia potrzebne do montażu



UWAGA !!!

MONTOWANIE USZKODZONYCH
ELEMENTÓW POWODUJE UTRATĘ
GWARANCJI

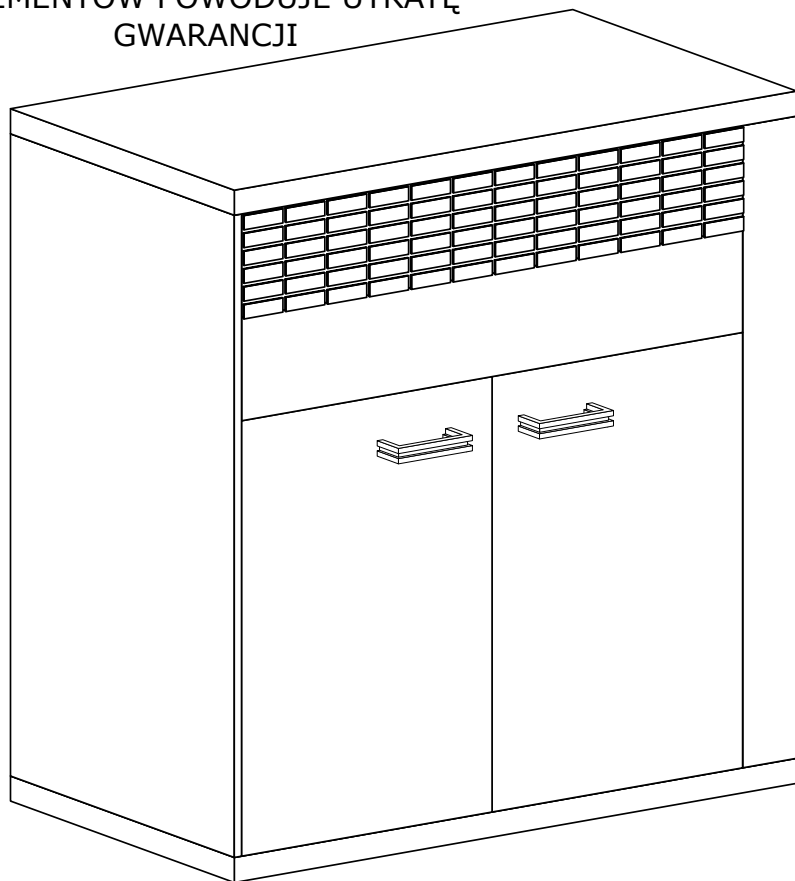

Nr	D[mm]	S[mm]	G[mm]	Ilość
1	1076	405	16	1
2	1076	389	16	1
3	1018	406	48	1
4	1018	406	48	1
5	983	389	16	1
6	389	389	16	1
7	983	389	16	1
8	1076	100	16	1
9	1008	345	2,5	2
10	1008	247	2,5	1
11	350	165	16	4
12	842	165	16	2
13	893	190	32	1
14	893	190	32	1
15	870	345	2,5	2
16	685	445	16	1

W przypadku reklamacji proszę podać numer pakowacza znajdujący się na kartonie.

UWAGA !!!

Mebel zawiera elementy drewniane

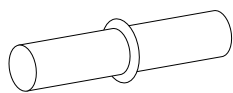

B - 4 St.



A - 2 St.

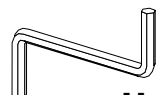

U - 1 St.

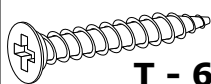

T - 60 St.
3x30 mm

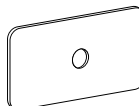

S - 8 St.

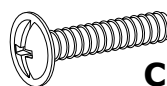

C - 4 St.
4x25 mm

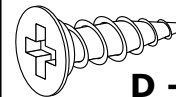

D - 16 St.
3,5x16 mm

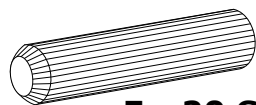

E - 20 St.

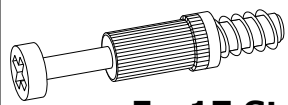

F - 17 St.



G - 17 St.

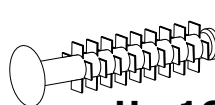

H - 16 St.



I - 50 St.

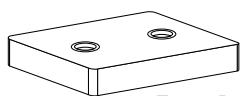

J - 4 St.

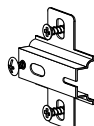

K - 2 St.

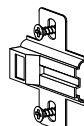

L - 2 St.

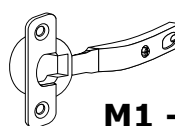

M1 - 1 St.

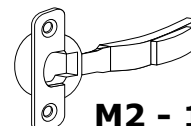

M2 - 1 St.

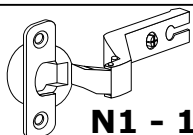

N1 - 1 St.

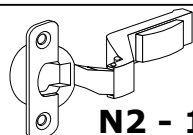

N2 - 1 St.

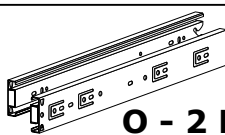

O - 2 Kpl.

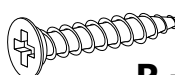

P - 8 St.
3,5x25 mm

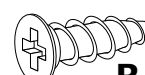

R - 16 St.
5x13 mm

I

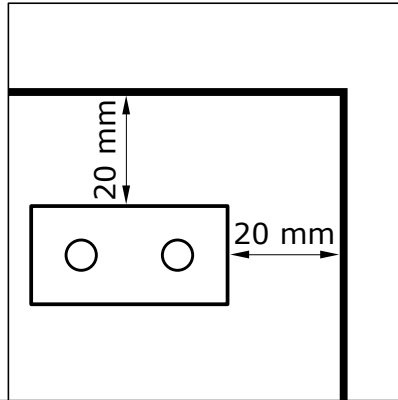
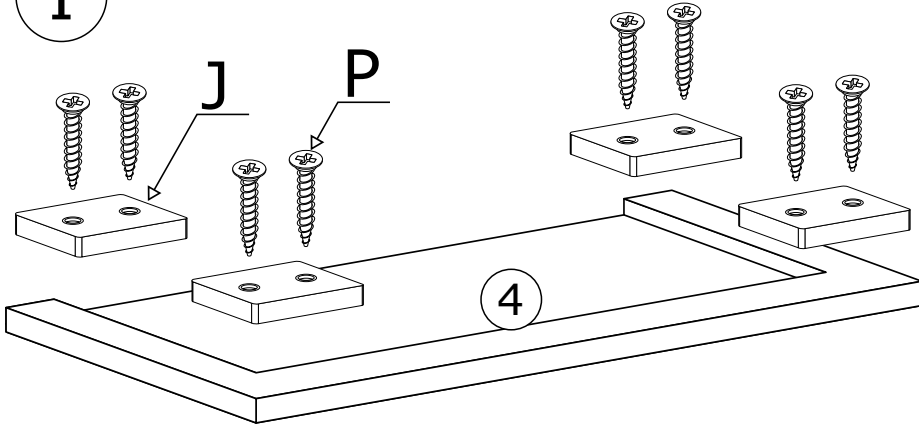

II

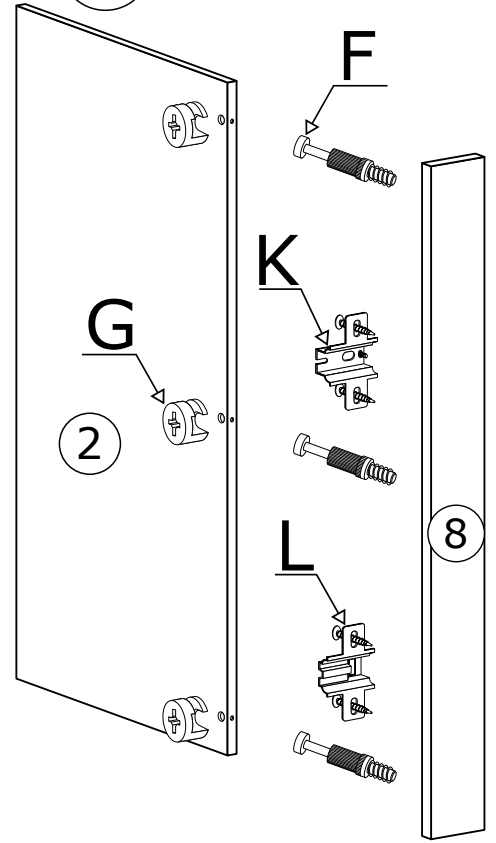

III

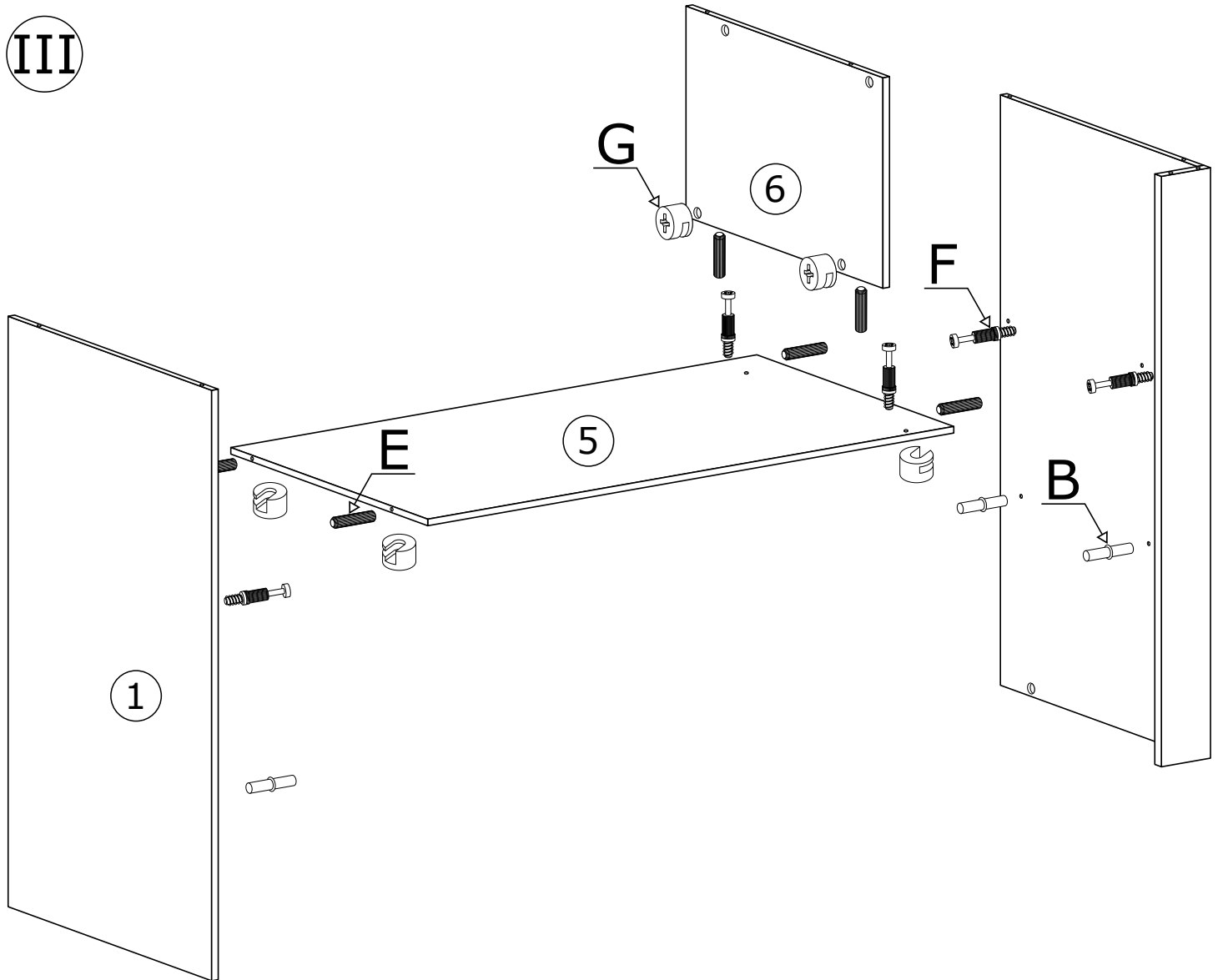

IV

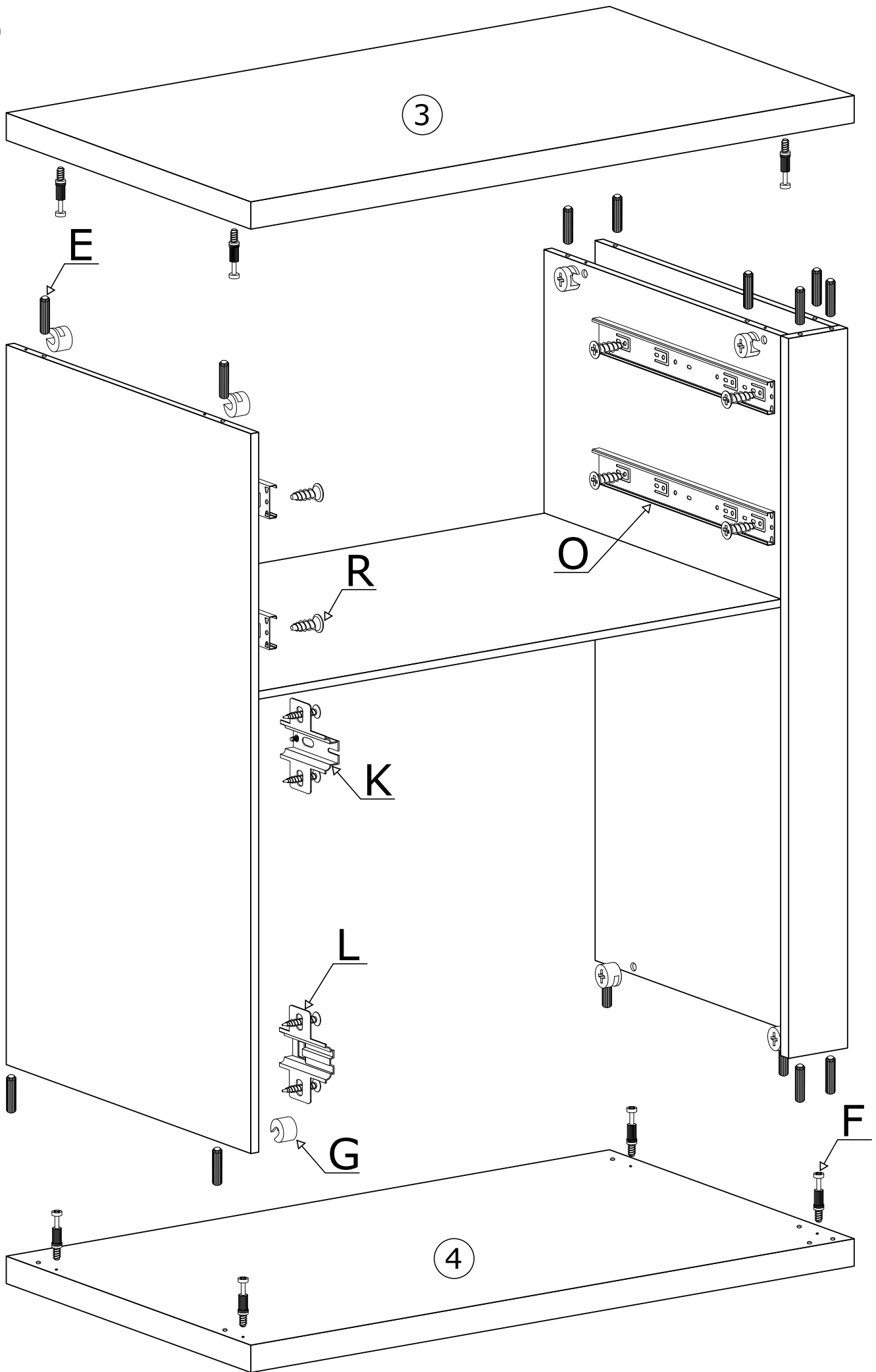

V

 x50

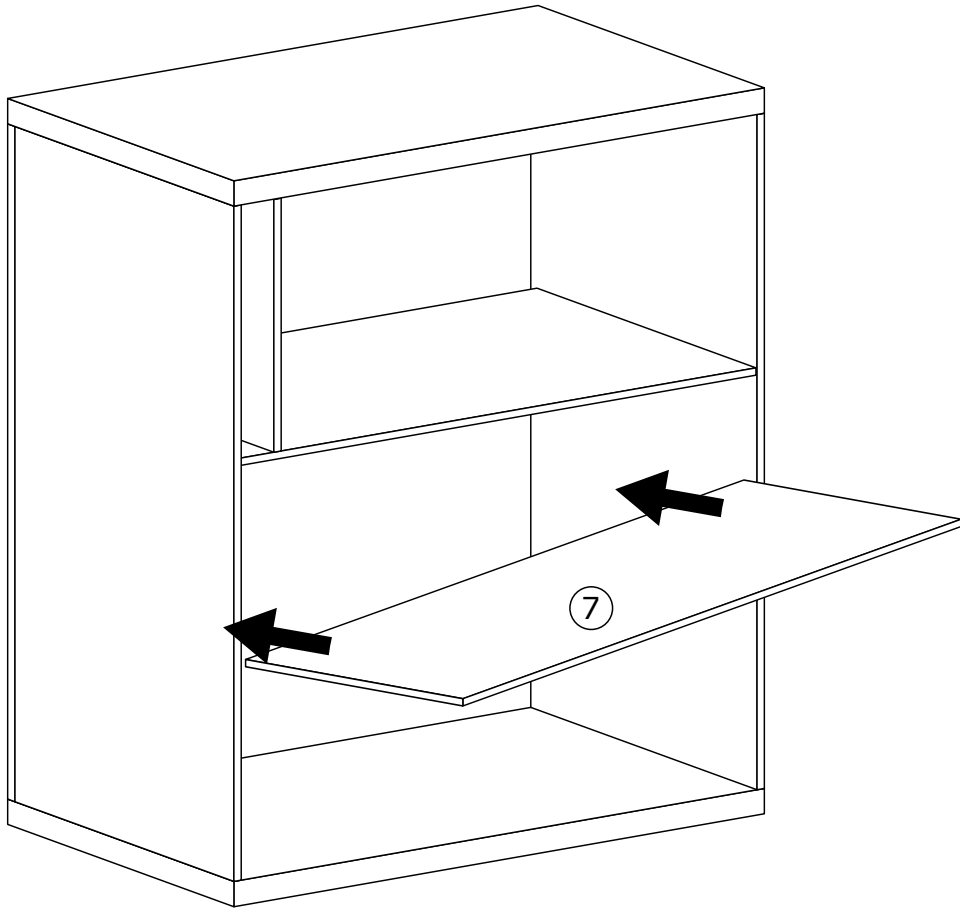

VI

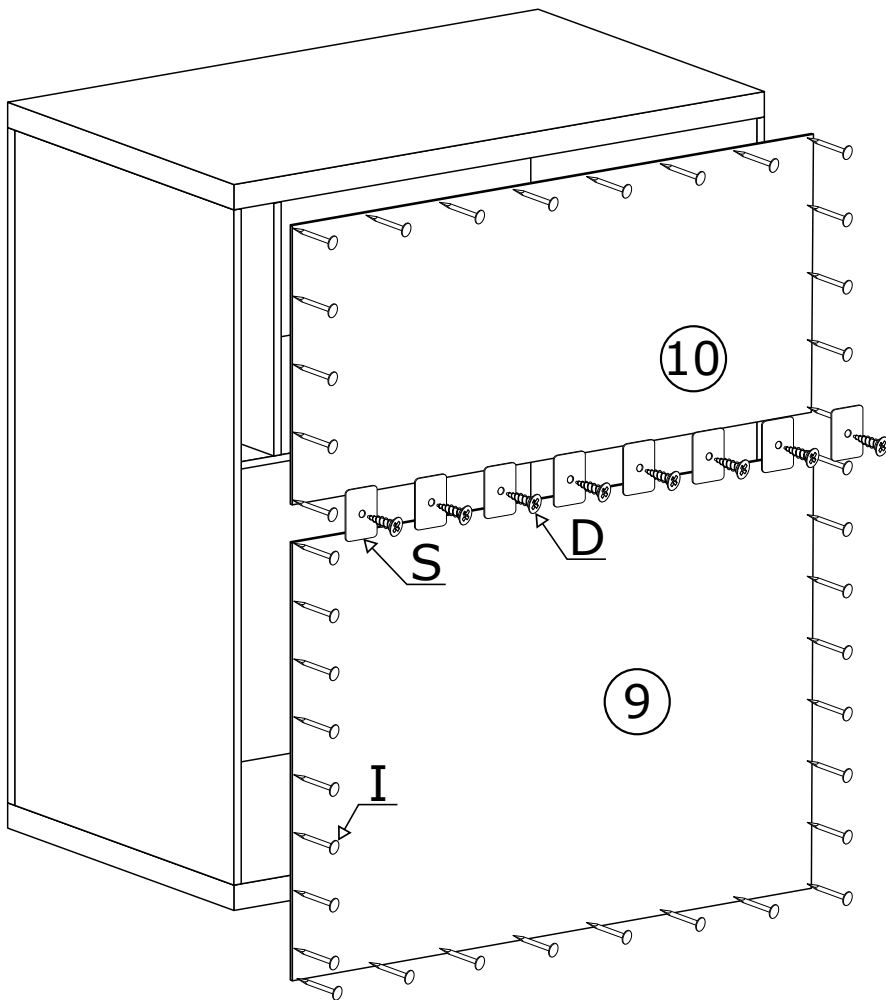

VII

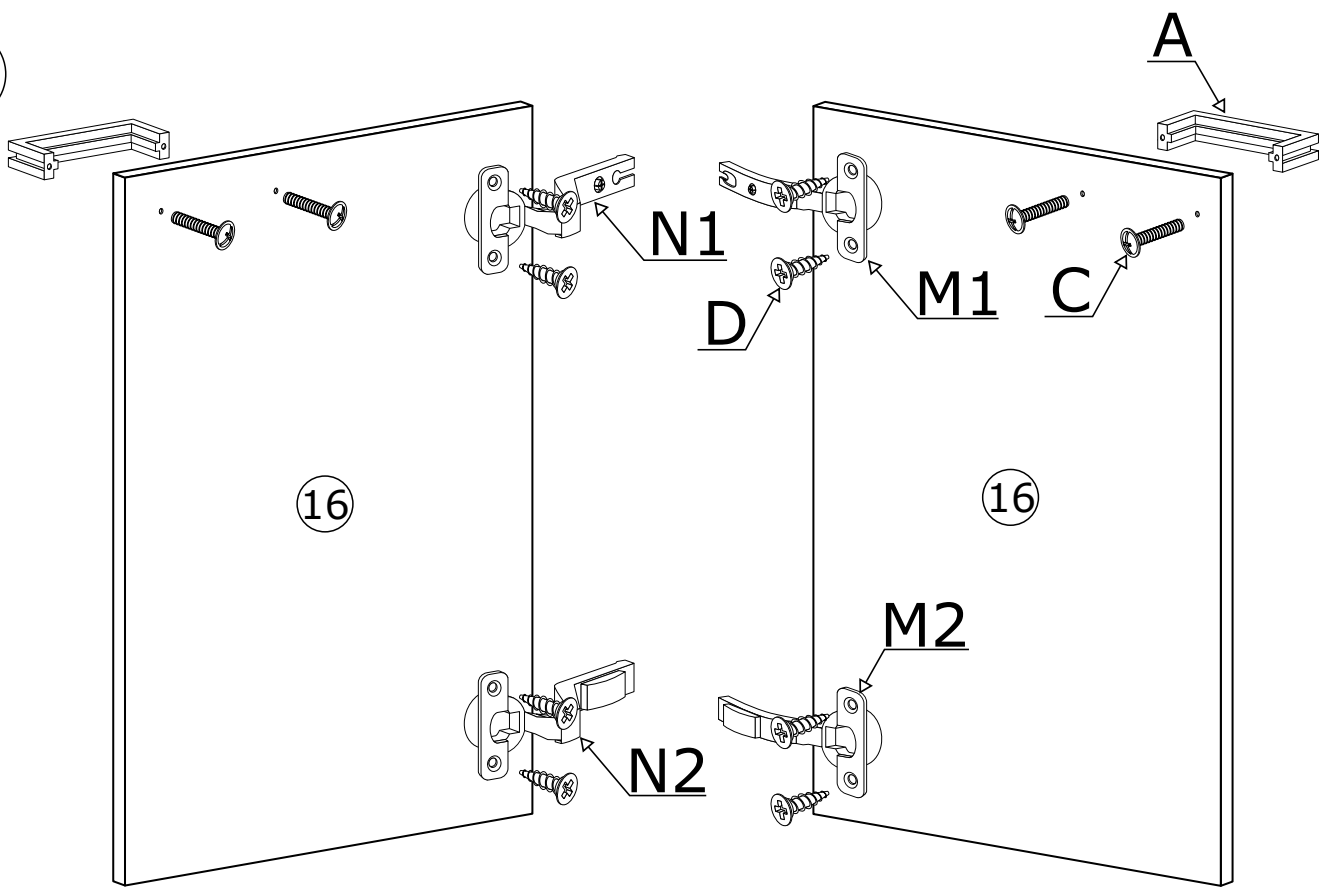

VIII

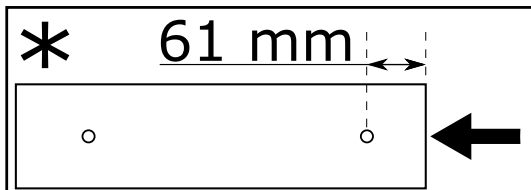
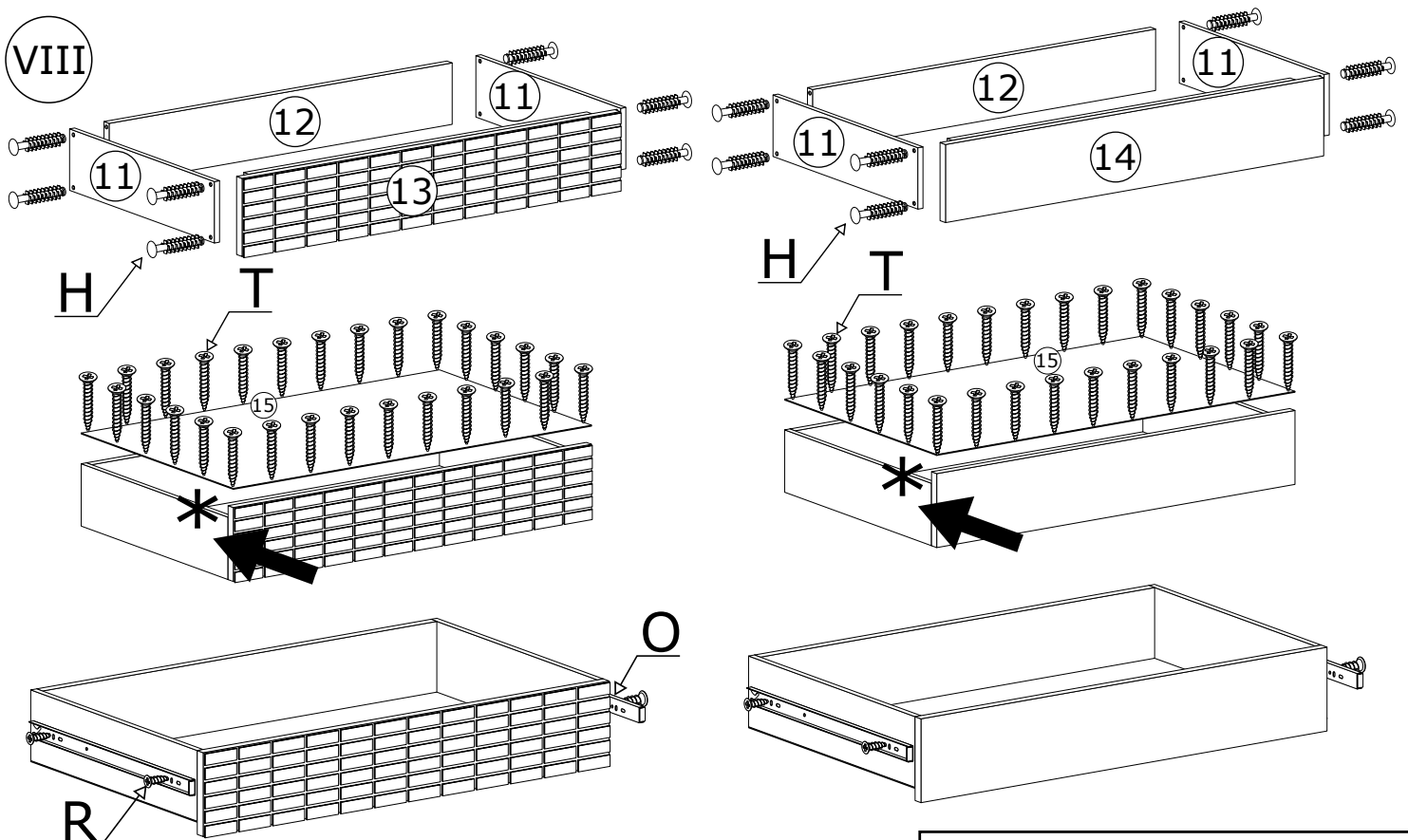

ELEMENT OZDOBNY WYKONANY RĘCZNIE Z PRAWDZIWEGO DREWNA. ODCIĘN DREWNA I OKŁAD SŁOJI MOGĄ NIEZNACZNIE ODBIEGAĆ OD PREZENTOWANYCH NA ZDJĘCIACH KATALOGOWYCH.

IX

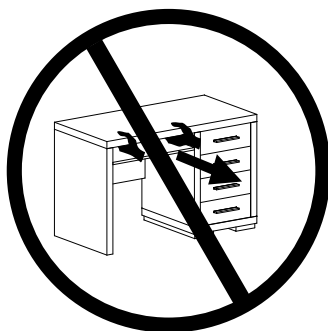
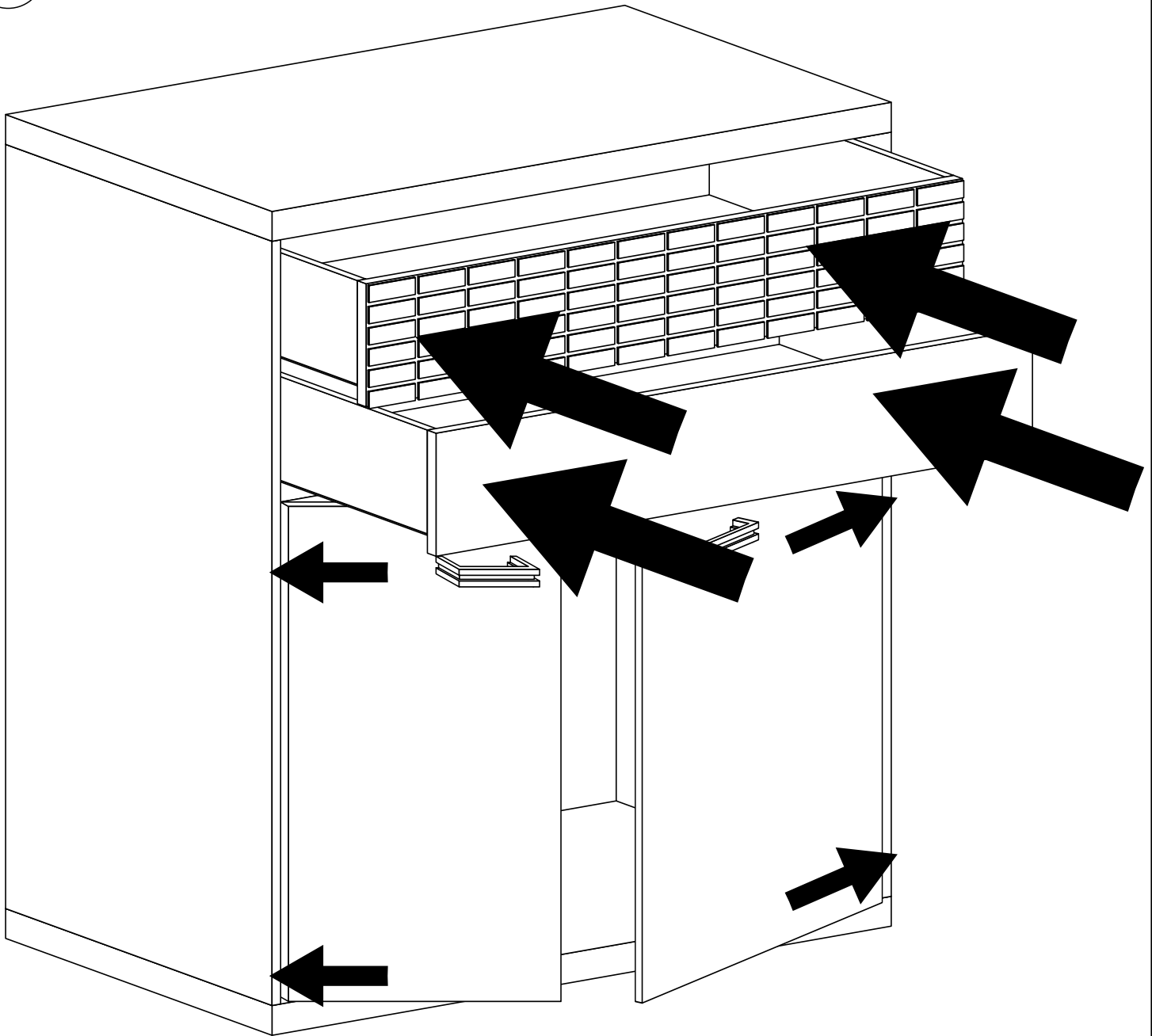

MONTAŻ/DEMONTAŻ PROWADNIC

1

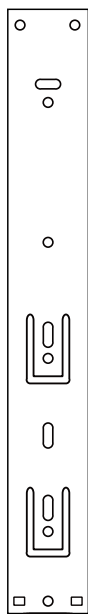

2

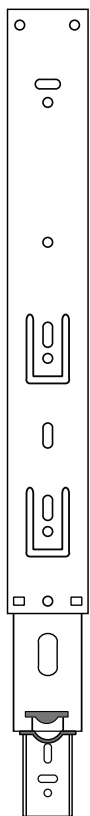

3

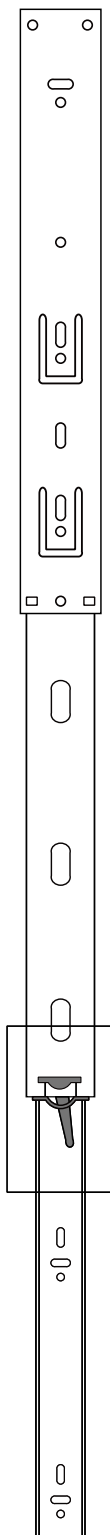

4

