

NATURAL 5



Narzędzia potrzebne do montażu



UWAGA !!!

MONTOWANIE USZKODZONYCH
ELEMENTÓW POWODUJE UTRATĘ
GWARANCJI

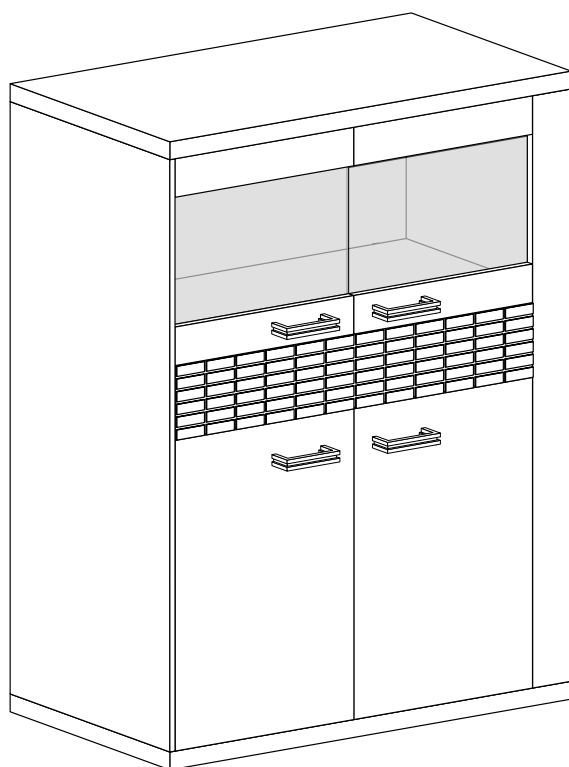

Nr	D[mm]	S[mm]	G[mm]	Ilość
1	1487	405	16	1
2	1487	389	16	1
3	1018	406	16	1
4	1018	406	16	1
5	983	405	16	1
6	983	389	16	1
7	389	197	16	1
8	1487	100	16	1
9	983	389	16	1
10	981	380	4	1
11	1008	690	2,5	1
12	1008	213	2,5	1
13	1008	630	2,5	1
14	350	165	16	2
15	842	165	16	1
16	892	190	32	1
17	505	345	2,5	1
18	685	445	16	2
19	445	100	16	2
20	445	100	16	2
21	443	413	4	2

UWAGA !!!

Mebel zawiera
elementy drewniane

W przypadku reklamacji proszę podać numer pakowacza znajdujący się na kartonie.



A - 4 St.

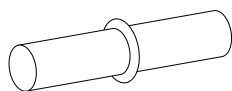

B - 4 St.

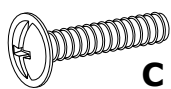

C - 8 St.
4x25 mm

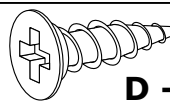

D - 42 St.
3,5x16 mm

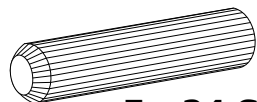

E - 24 St.

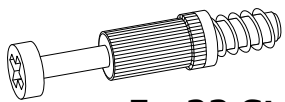

F - 22 St.

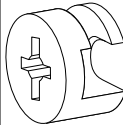

G - 22 St.

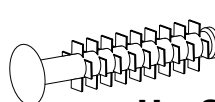

H - 8 St.



I - 50 St.

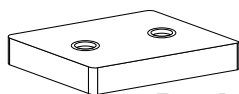

J - 4 St.

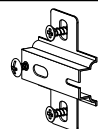

K - 4 St.

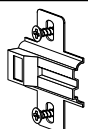

L - 4 St.

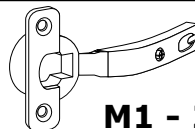

M1 - 2 St.

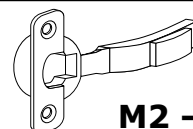

M2 - 2 St.

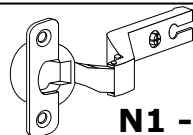

N1 - 2 St.

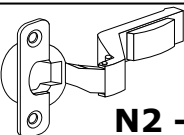

N2 - 2 St.

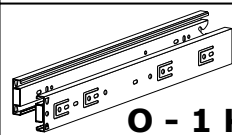

O - 1 Kpl.

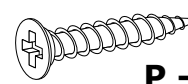

P - 8 St.
3,5x25 mm

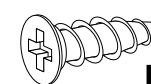

R - 8 St.
5x13 mm

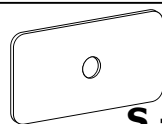

S - 14 St.

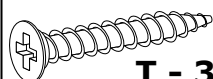

T - 30 St.
3x30 mm

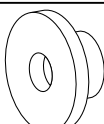

U - 12 St.

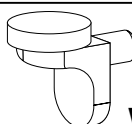

W - 8 St.

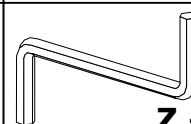

Z - 1 St.

I

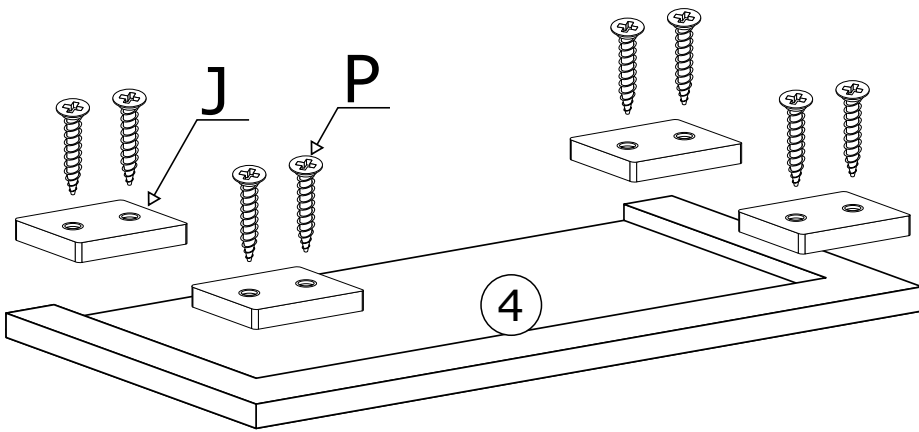

4

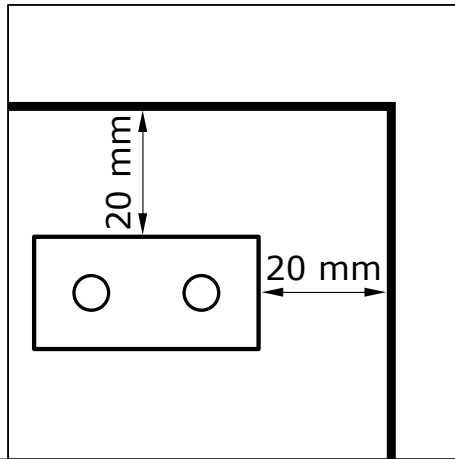

20 mm

20 mm

II

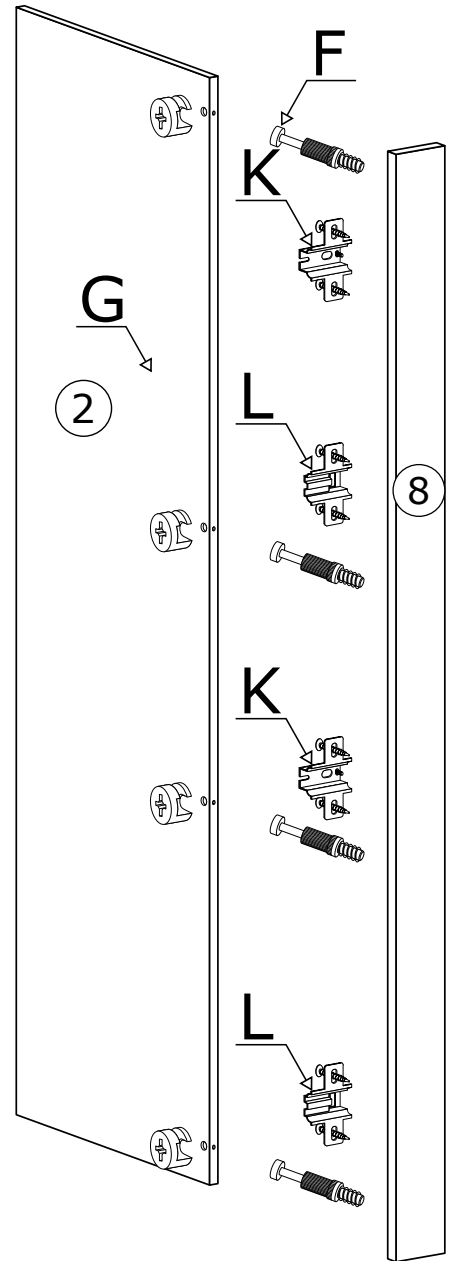

2

8

III

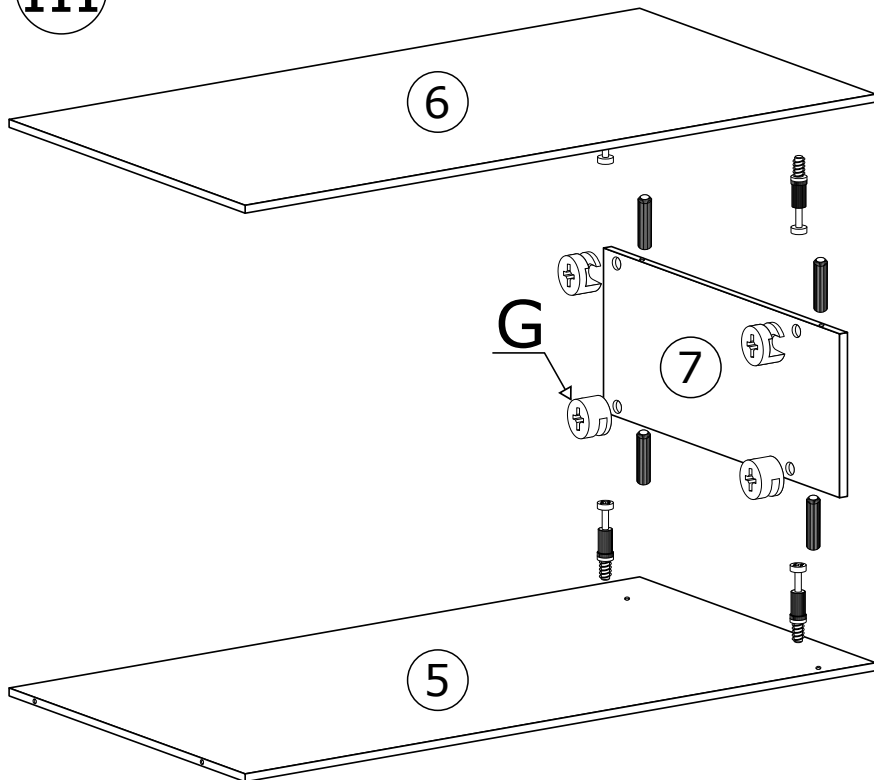

6

7

5

IV

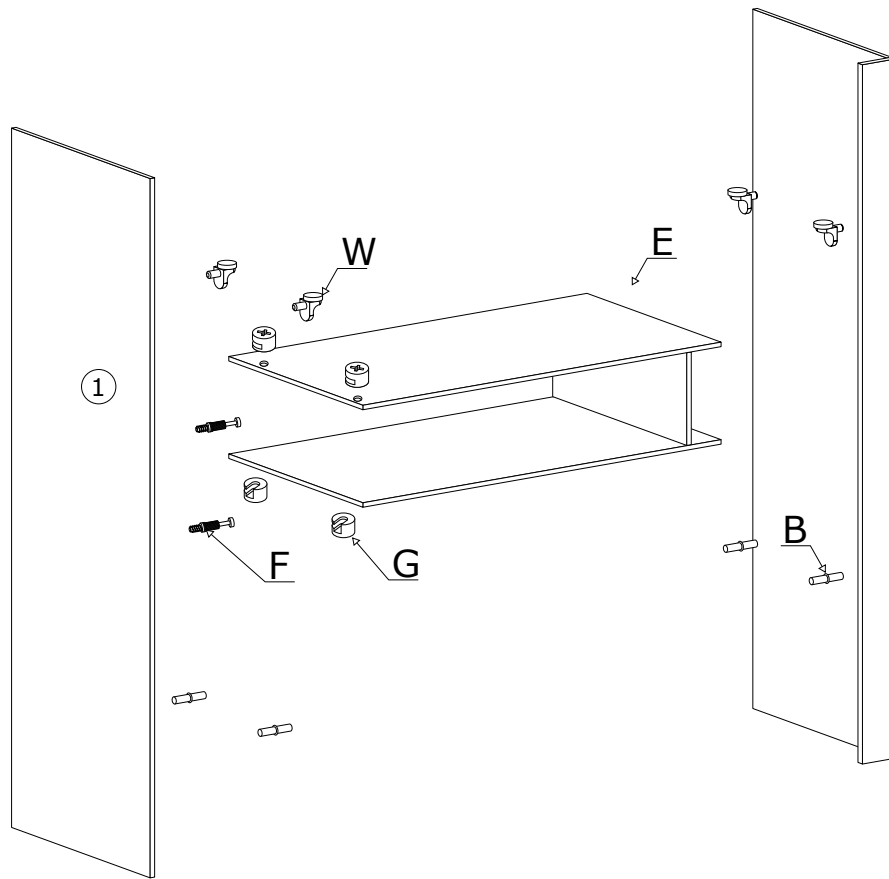

V

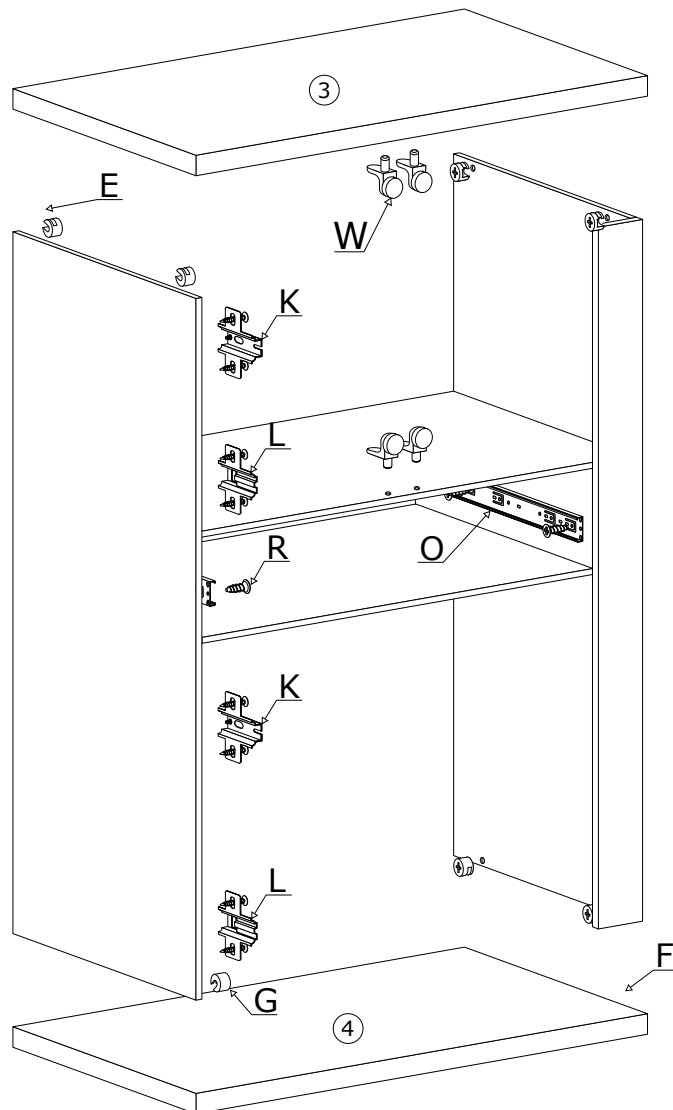

VIII

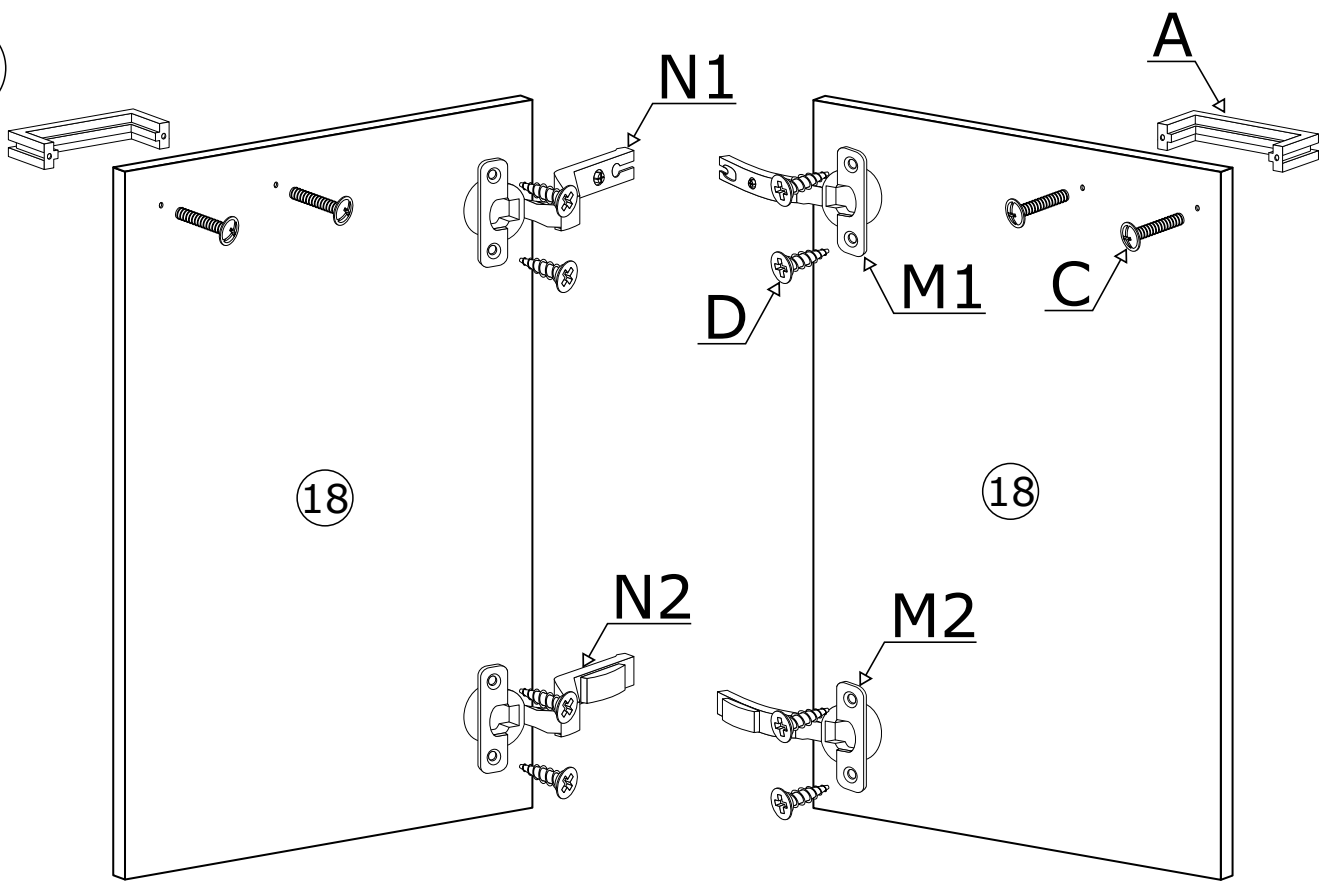

IX

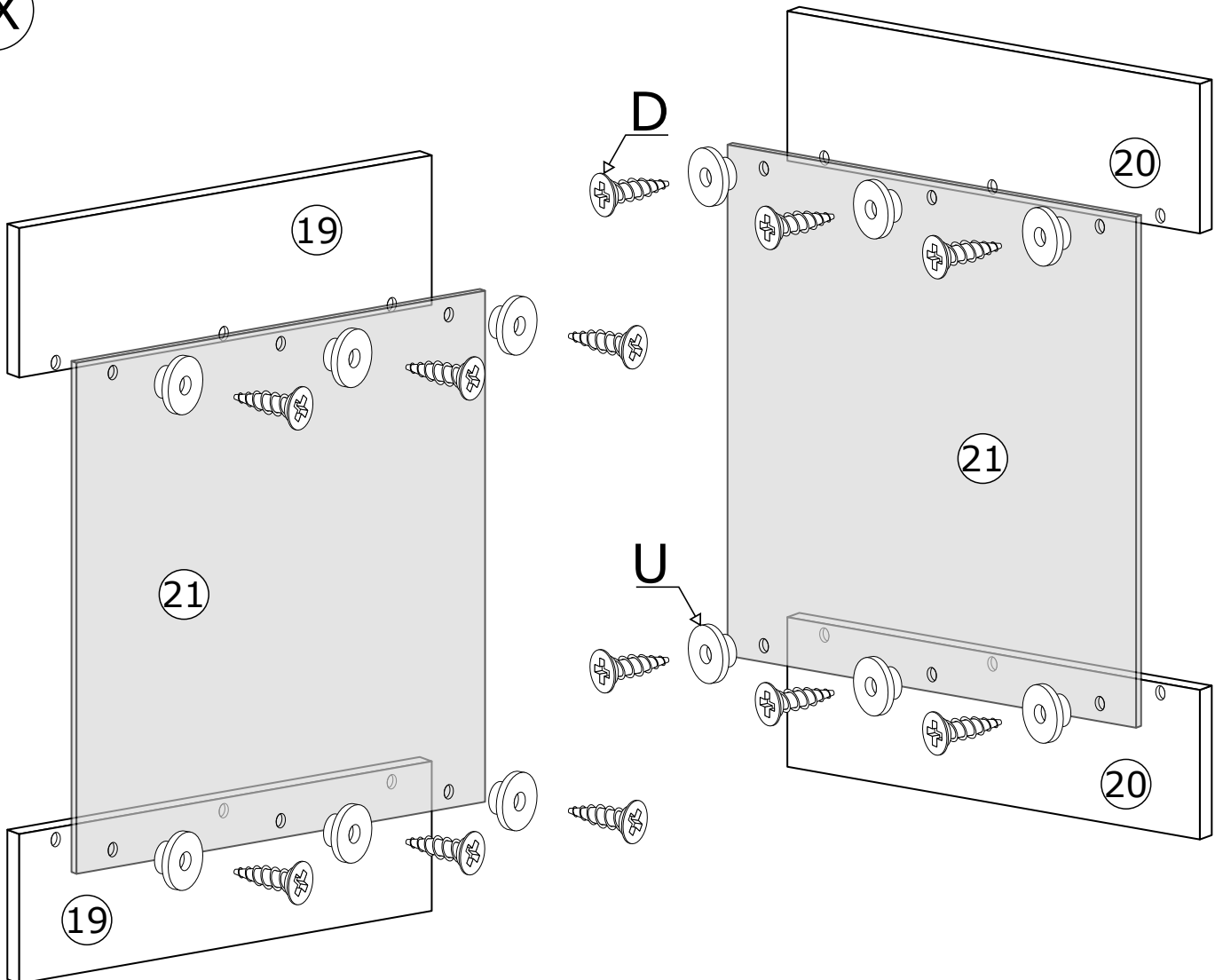

X

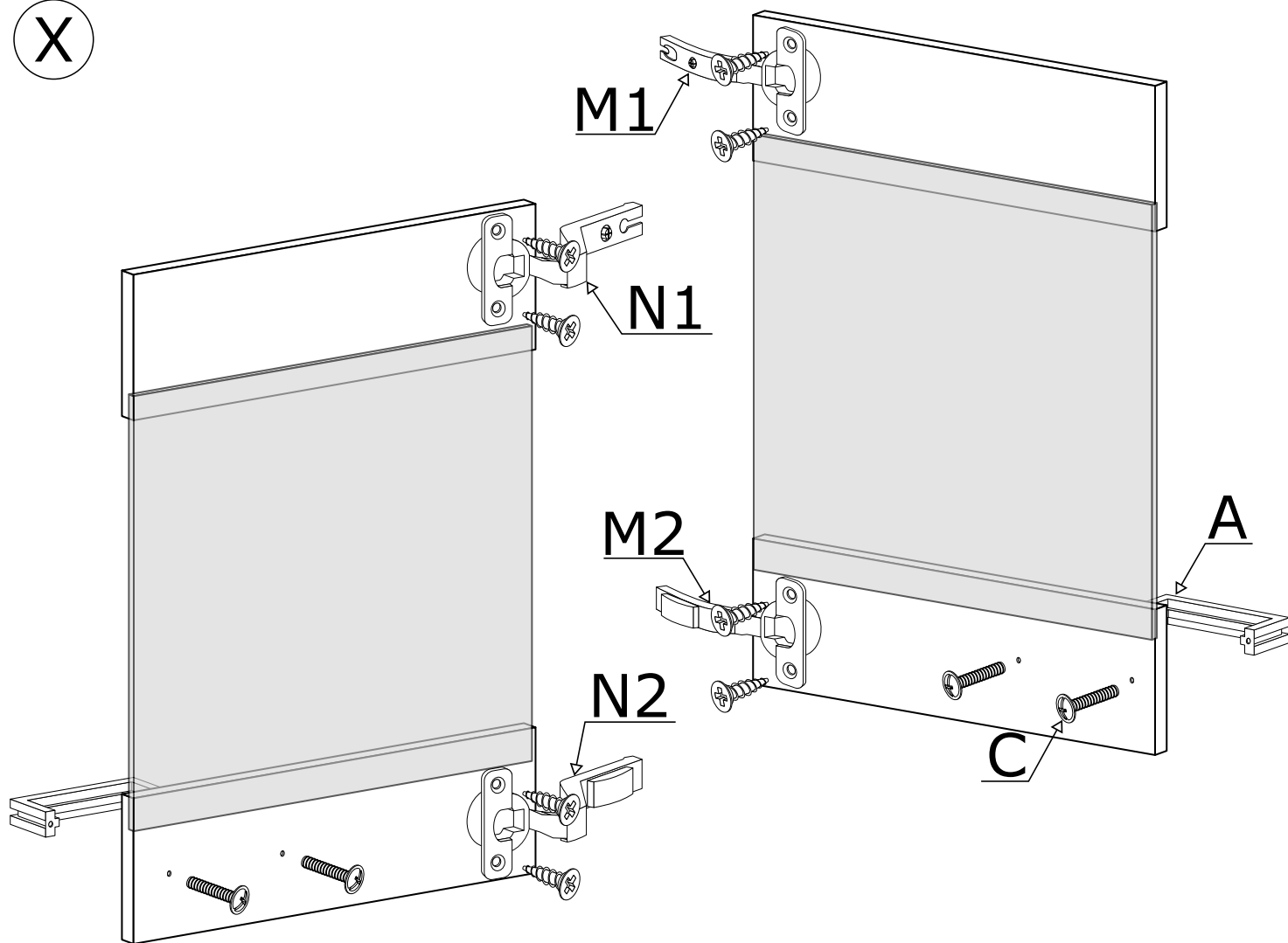

XI

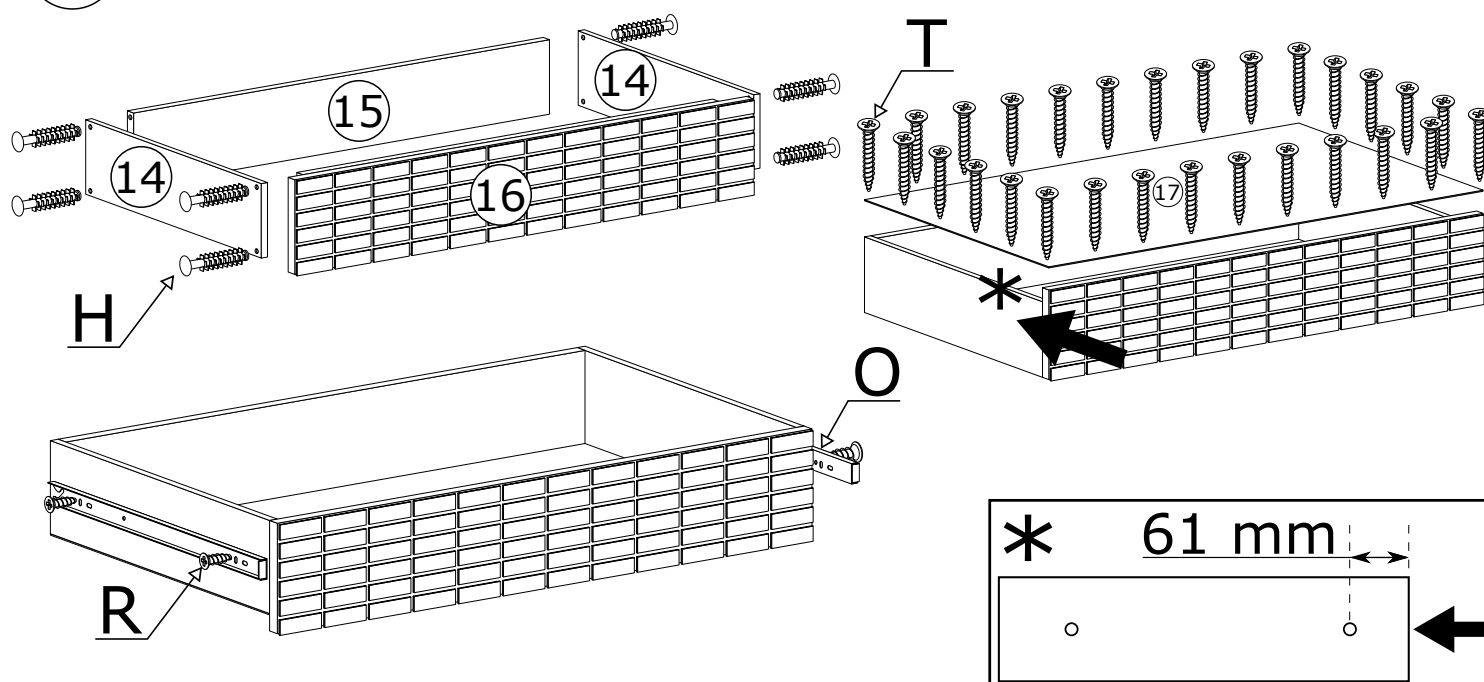

ELEMENT OZDOBNY WYKONANY RĘCZNIE Z PRAWDZIWEGO DREWNA. ODCIEŃ DREWNA I OKŁAD SŁOI MOGĄ NIEZNACZNIE ODBIEGAĆ OD PREZENTOWANYCH NA ZDJĘCIACH KATALOGOWYCH.

XII

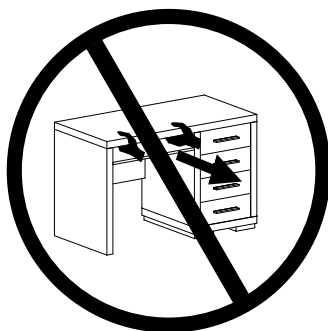
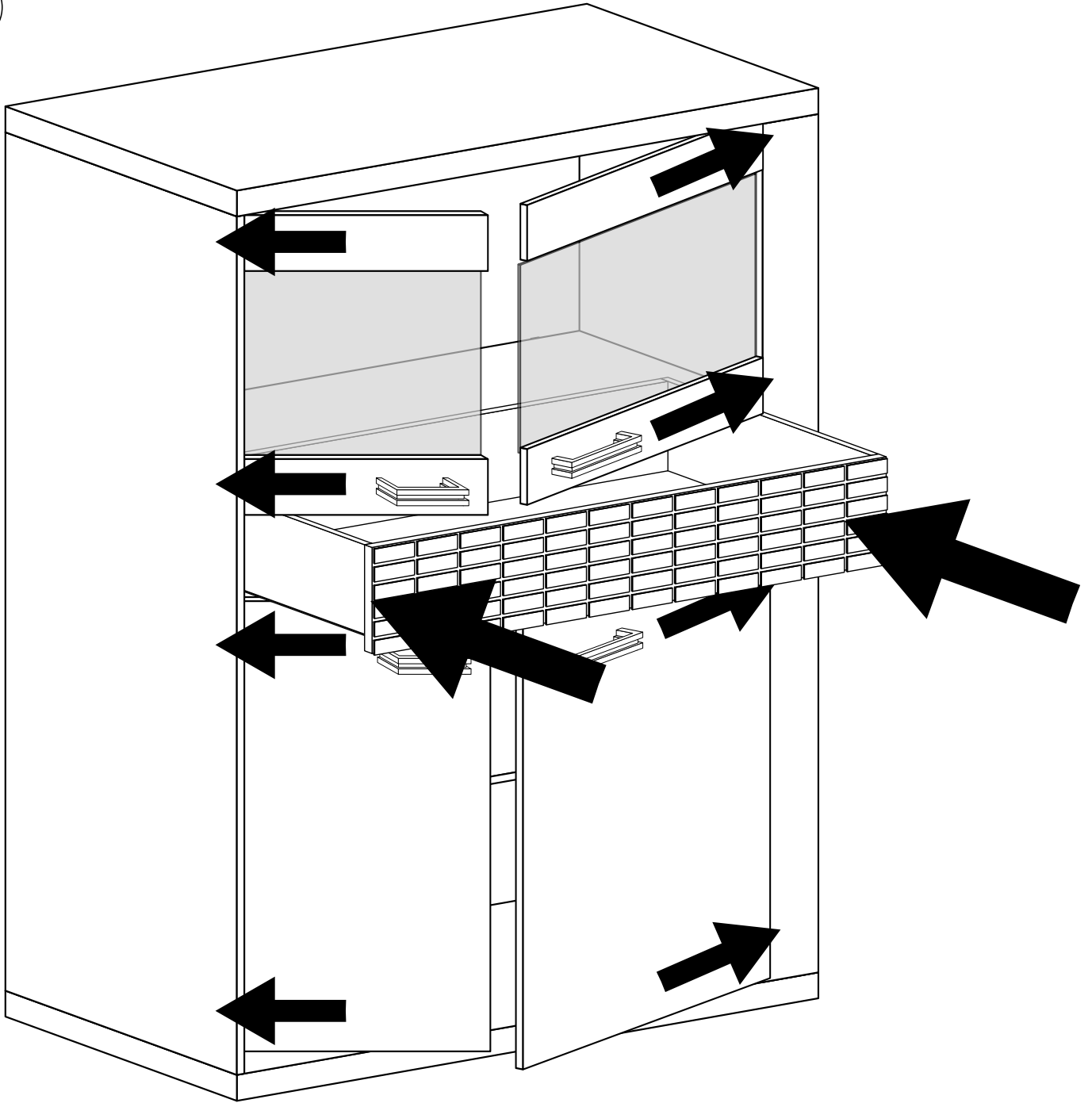

MONTAŻ/DEMONTAŻ PROWADNIC

1



2



3

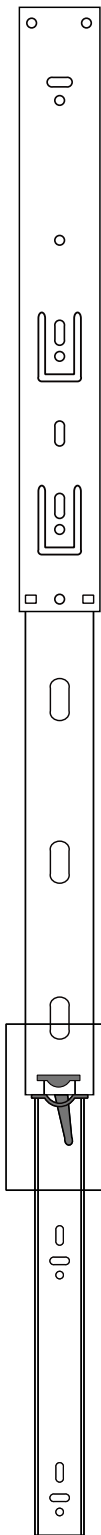

4

