

NATURAL 4

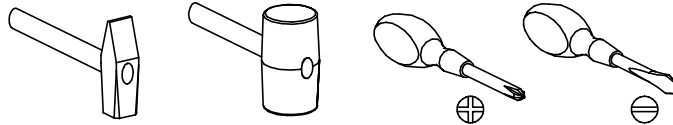

Narzędzia potrzebne do montażu



UWAGA !!!
 MONTOWANIE
 USZKODZONYCH
 ELEMENTÓW
 POWODUJE
 UTRATĘ
 GWARANCJI

Nr	D[mm]	S[mm]	G[mm]	Ilość
1	1900	405	16	1
2	1900	389	16	1
3	568	406	48	1
4	568	406	48	1
5	533	389	16	2
6	533	405	16	1
7	389	197	16	1
8	1900	100	16	1
9	533	389	16	1
10	530	380	4	2
11	1950	280	2,5	2
12	350	165	16	2
13	393	165	16	1
14	445	195	35	1
15	420	345	2,5	1
16	685	445	16	1
17	445	100	16	2
18	825	443	4	1

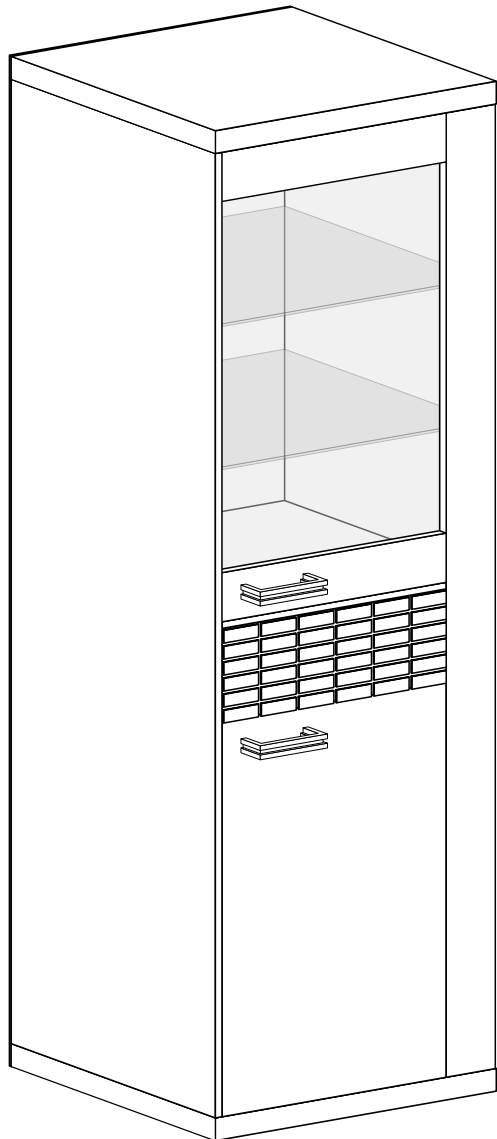

UWAGA !!!

Mebel zawiera
 elementy drewniane



A - 2 St.

W przypadku reklamacji proszę podać numer pakowacza znajdujący się na kartonie.

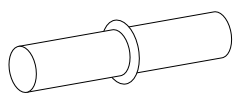

B - 4 St.

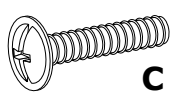

C - 4 St.
 4x25 mm

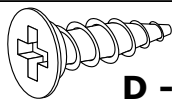

D - 14 St.
 3,5x16 mm

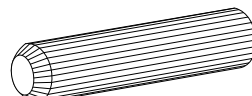

E - 24 St.

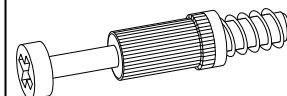

F - 23 St.

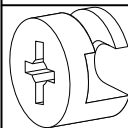

G - 23 St.

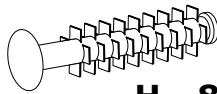

H - 8 St.



I - 60 St.

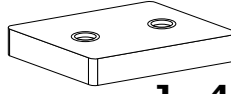

J - 4 St.

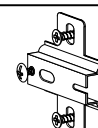

K - 2 St.

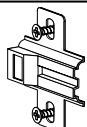

L - 2 St.

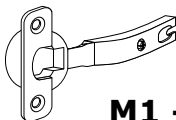

M1 - 2 St.

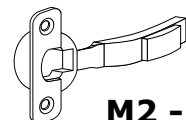

M2 - 2 St.

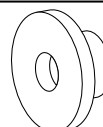

N - 6 St.

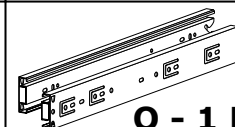

O - 1 Kpl.

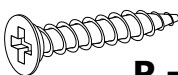

P - 8 St.
 3,5x25 mm

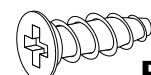

R - 8 St.
 5x13 mm

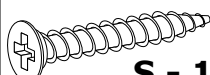

S - 18 St.
 3x30 mm

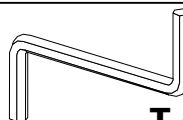

T - 1 St.

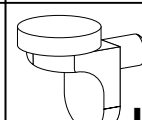

U - 10 St.

I

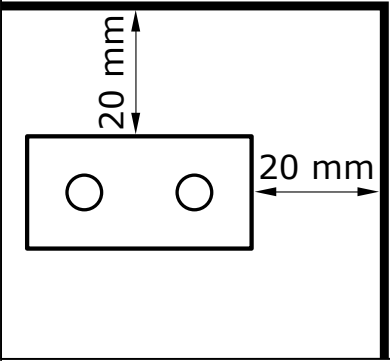
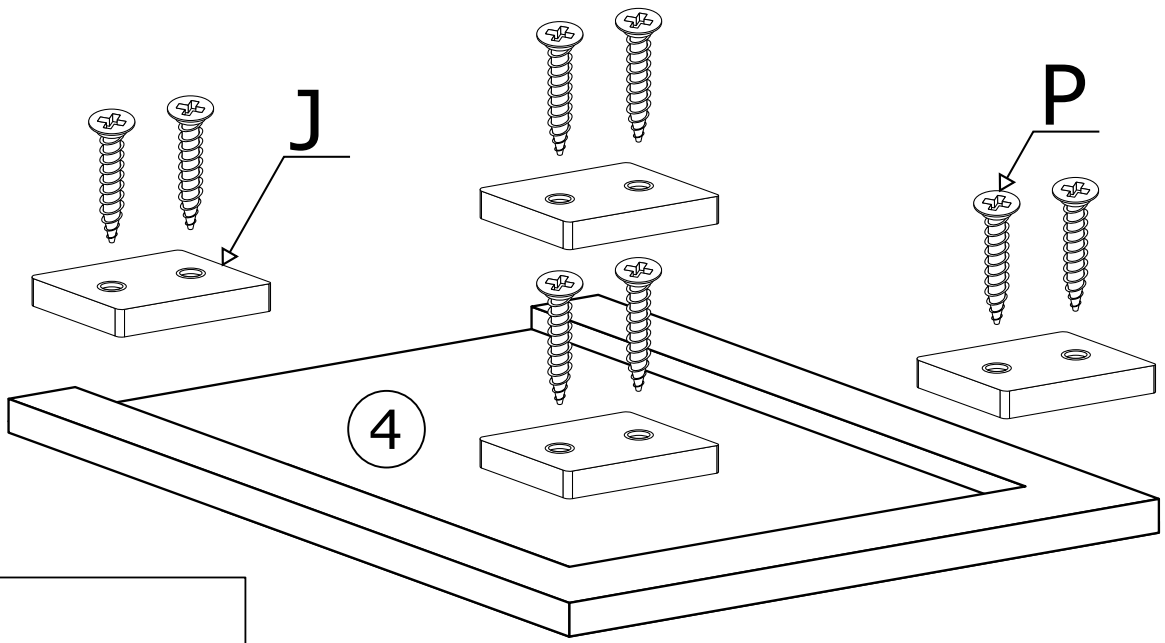

II

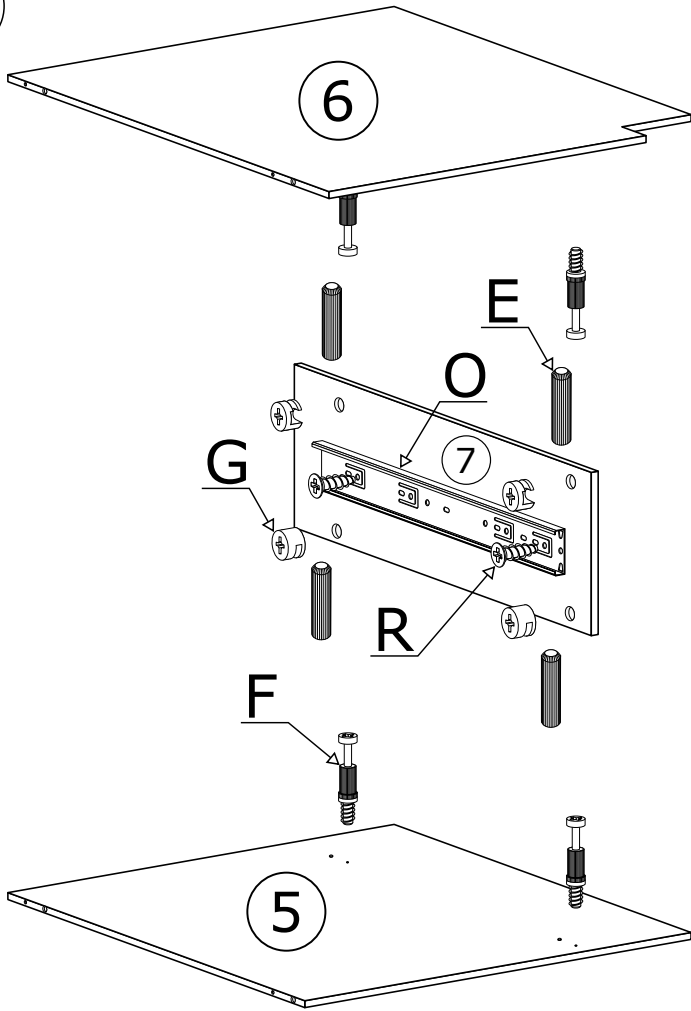

III

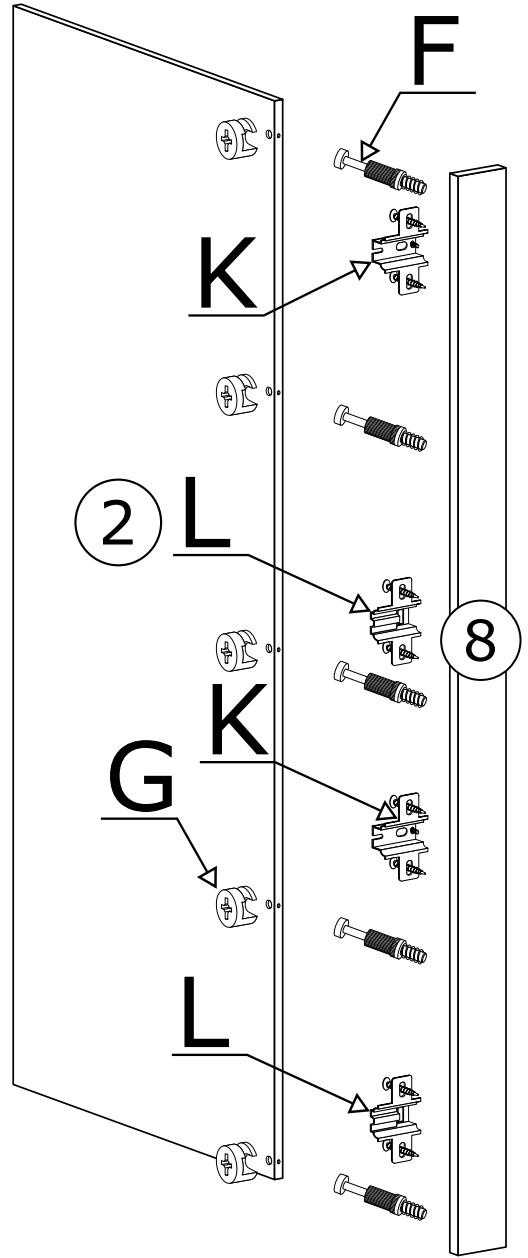

IV

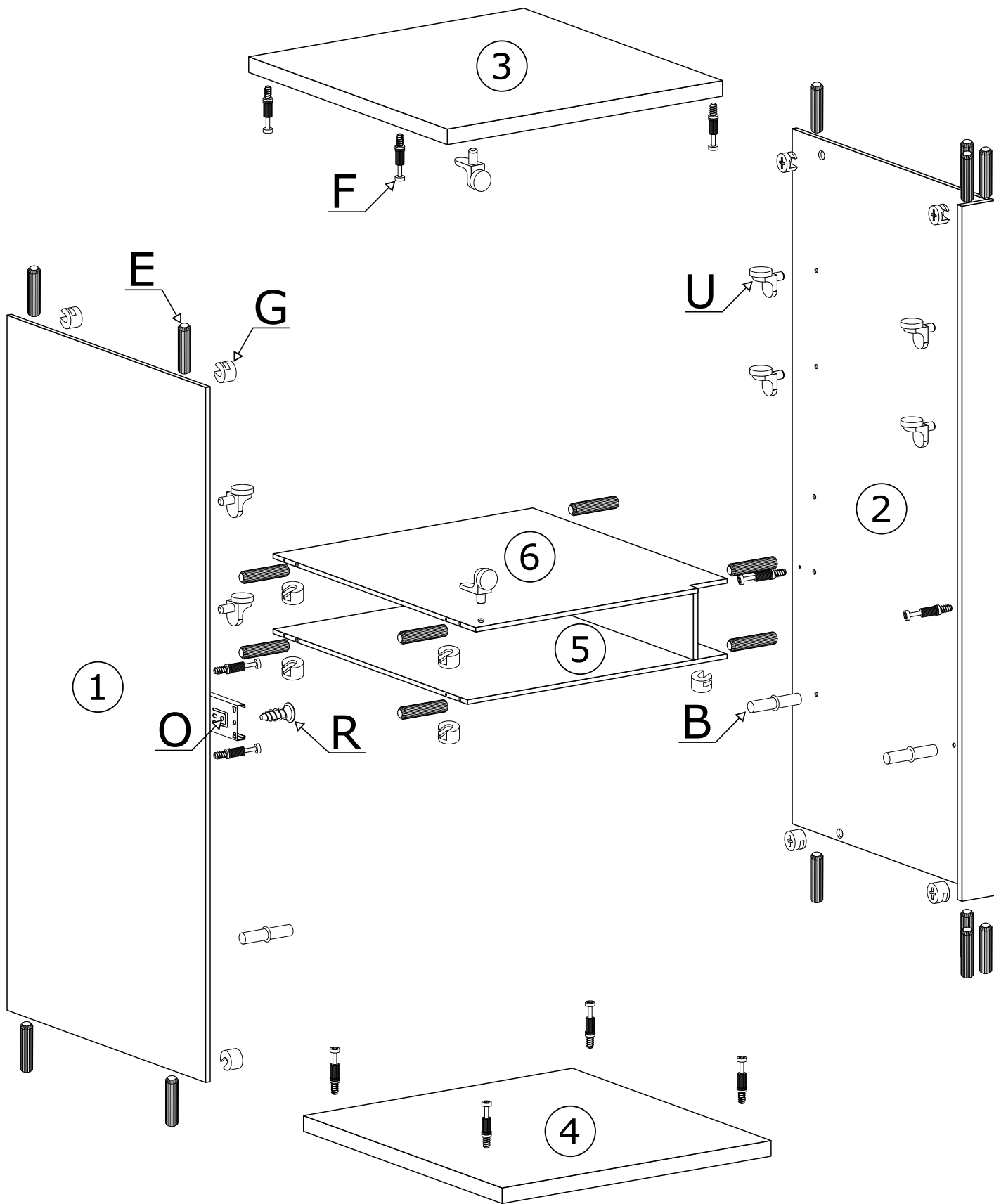

V

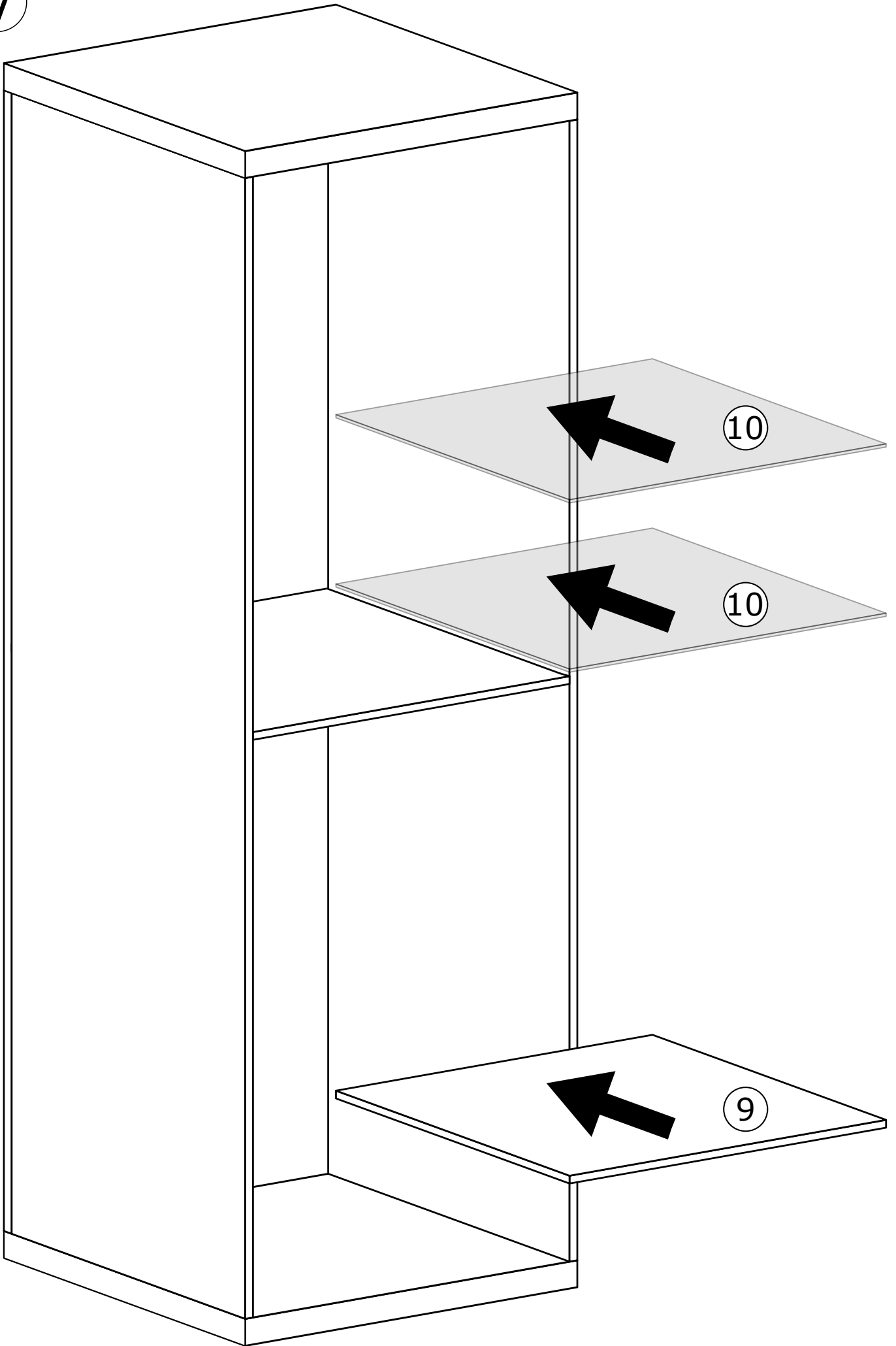

VI

x60

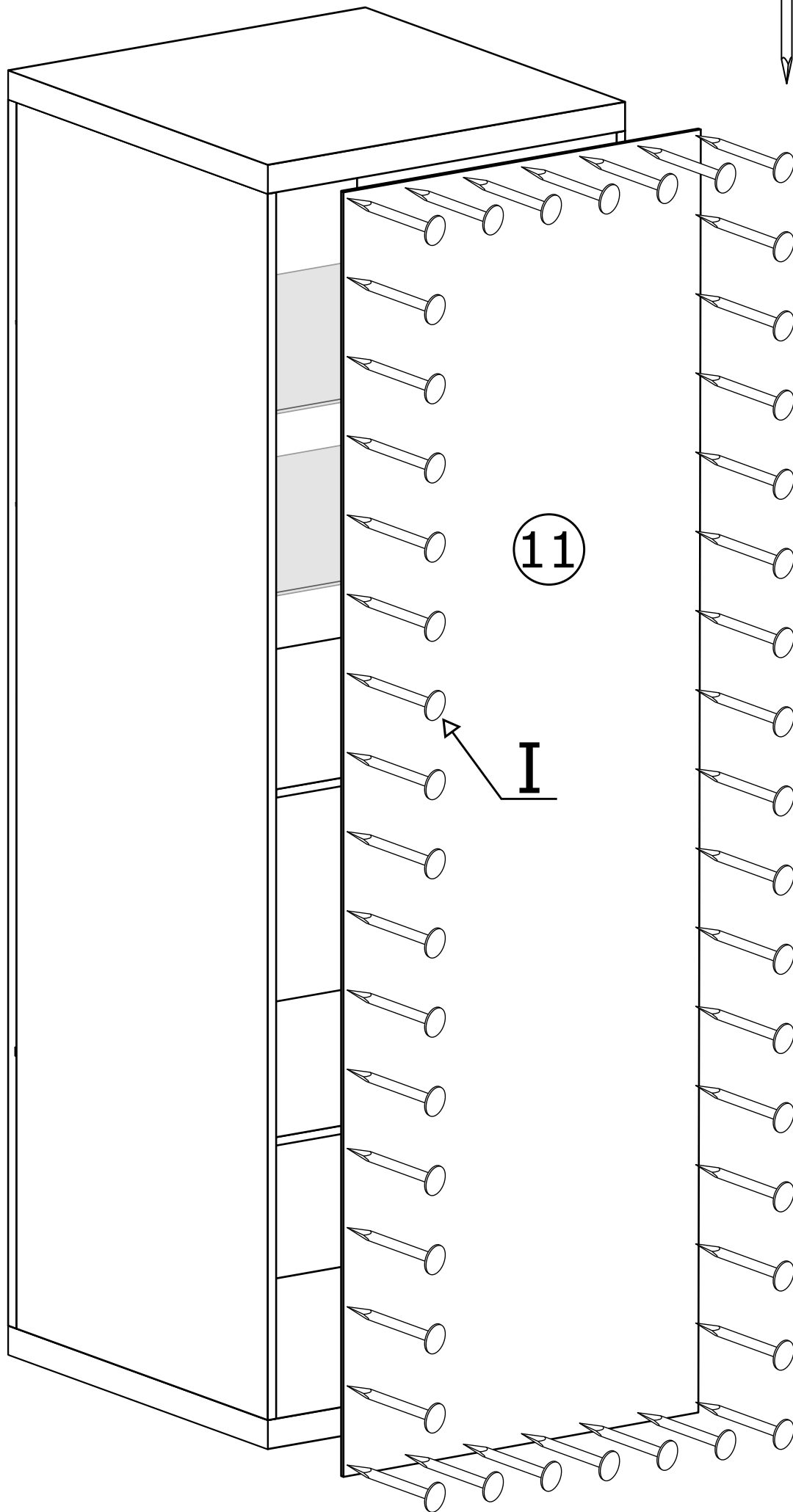

11

I

VII

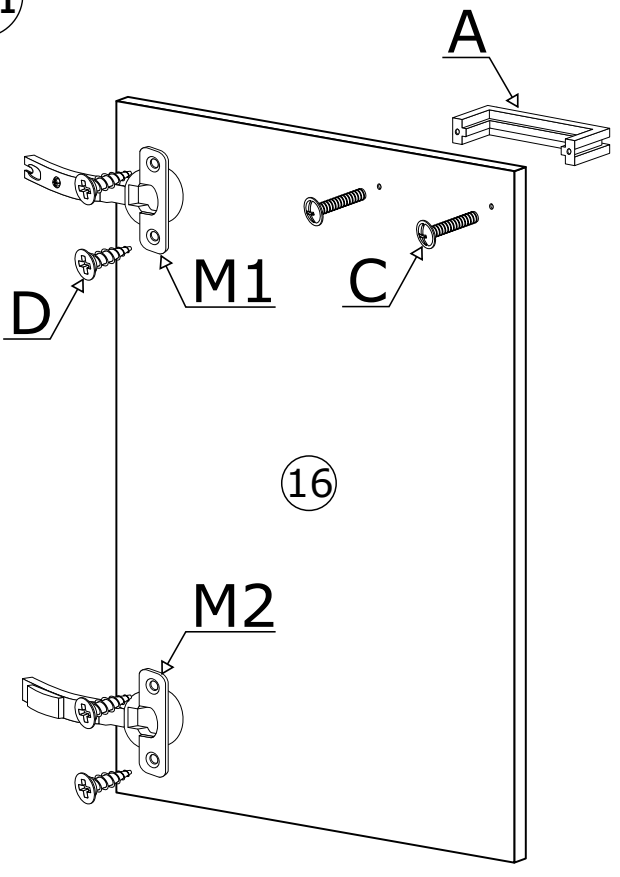

VIII

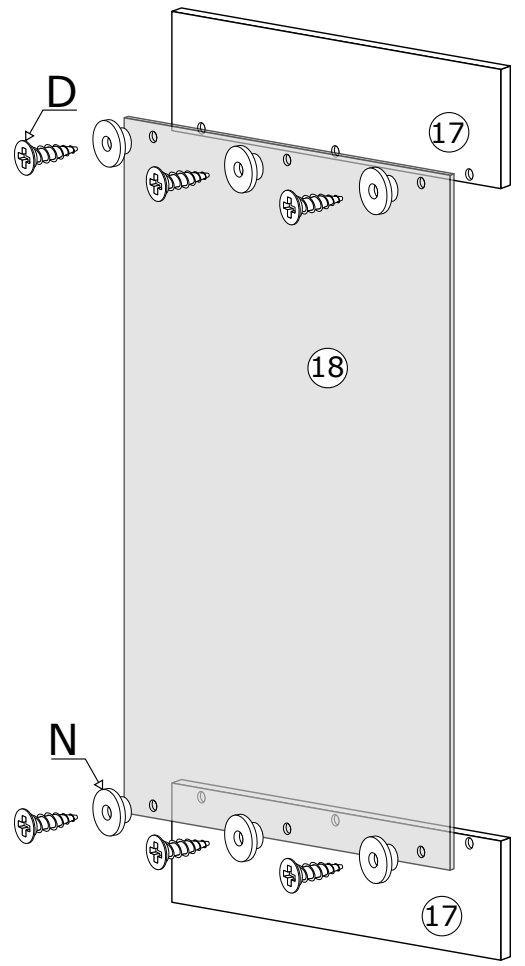

IX

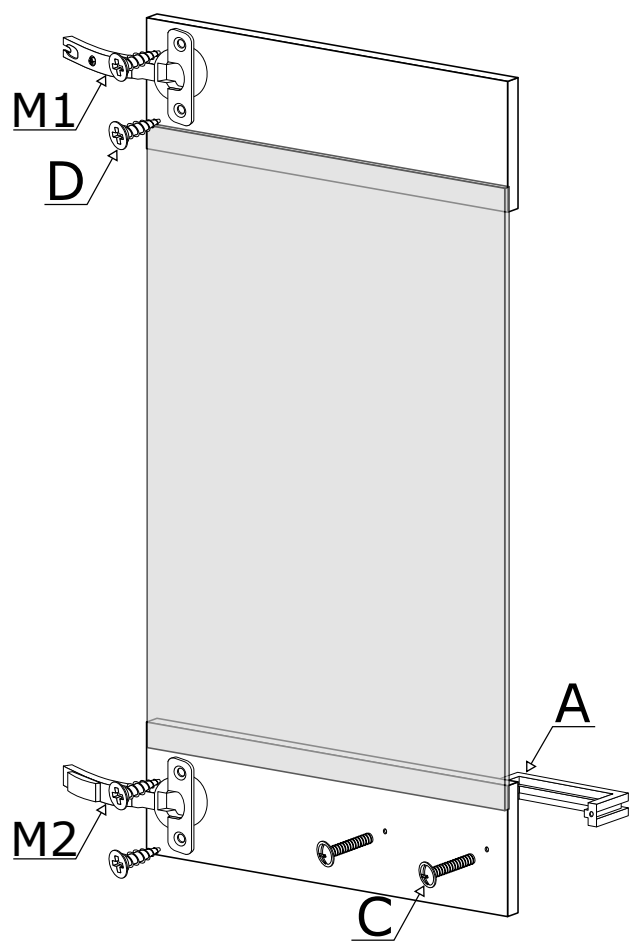

X

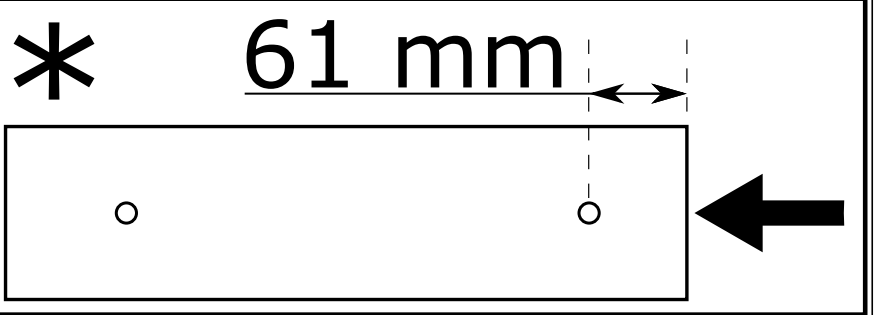
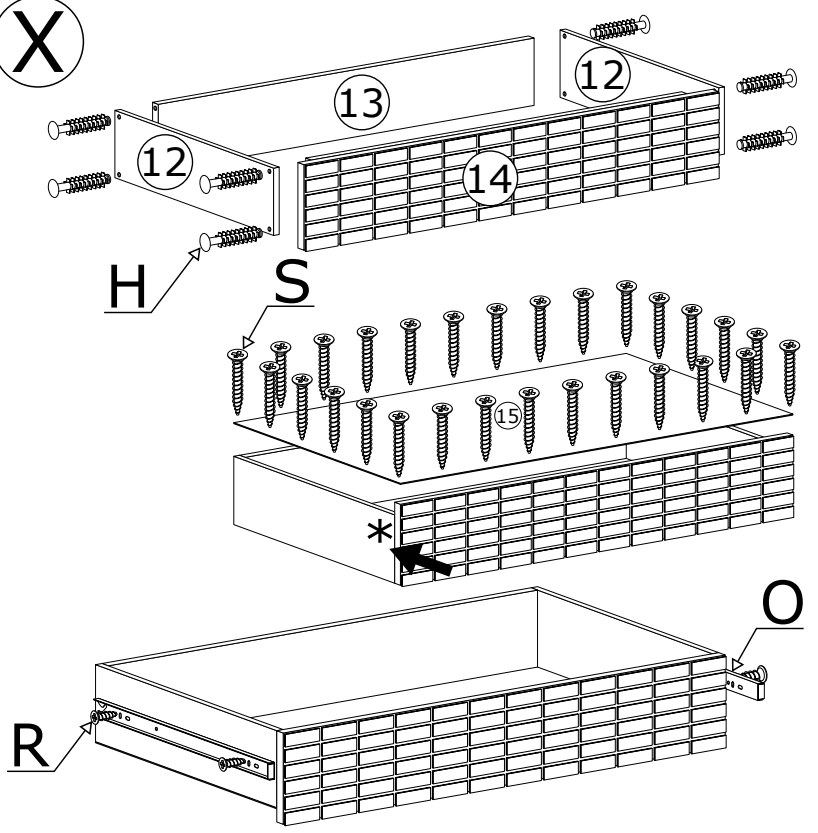

XI

ELEMENT OZDOBNY WYKONANY RĘCZNIE Z PRAWDZIWEGO DREWNA. ODCIĘĆ DREWNA I OKŁAD SŁOI MOGĄ NIEZNACZNIE ODBIEGAĆ OD PREZENTOWANYCH NA ZDJĘCIACH KATALOGOWYCH.

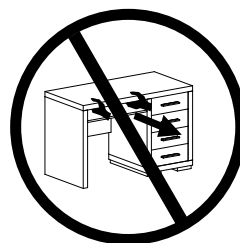
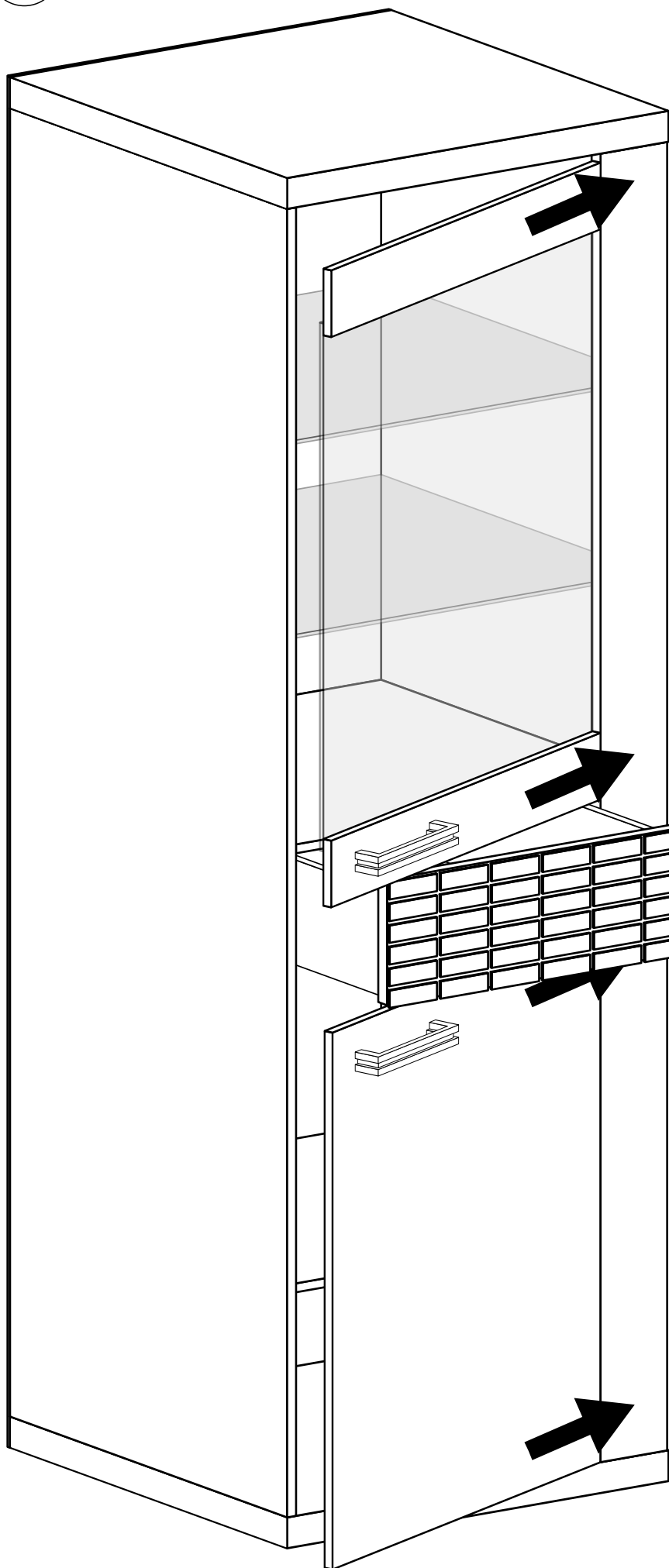

MONTAŻ/DEMONTAŻ PROWADNIC

1

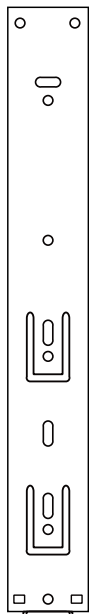

2

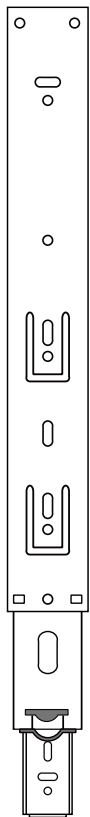

3

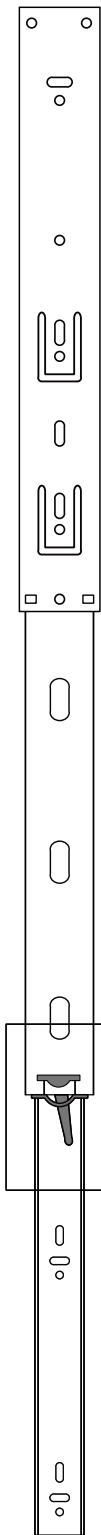

4

