

# ORLANDO 19

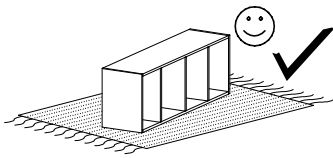

Narzędzia potrzebne do montażu

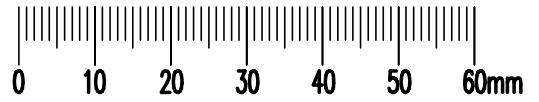
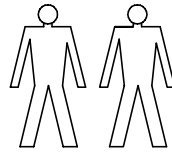
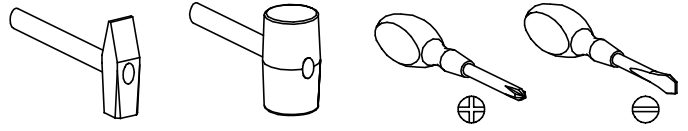

## **UWAGA !!!**

MONTOWANIE USZKODZONYCH  
ELEMENTÓW POWODUJE UTRATĘ  
GWARANCJI

Nr	D[mm]	S[mm]	G[mm]	Ilość
1	1700	700	48	1
2L	2000	200	48	1
2P	2000	200	48	1
3	1700	400	48	1
4	1985	200	48	1
5	265	190	48	2
6	1600	30	3	1

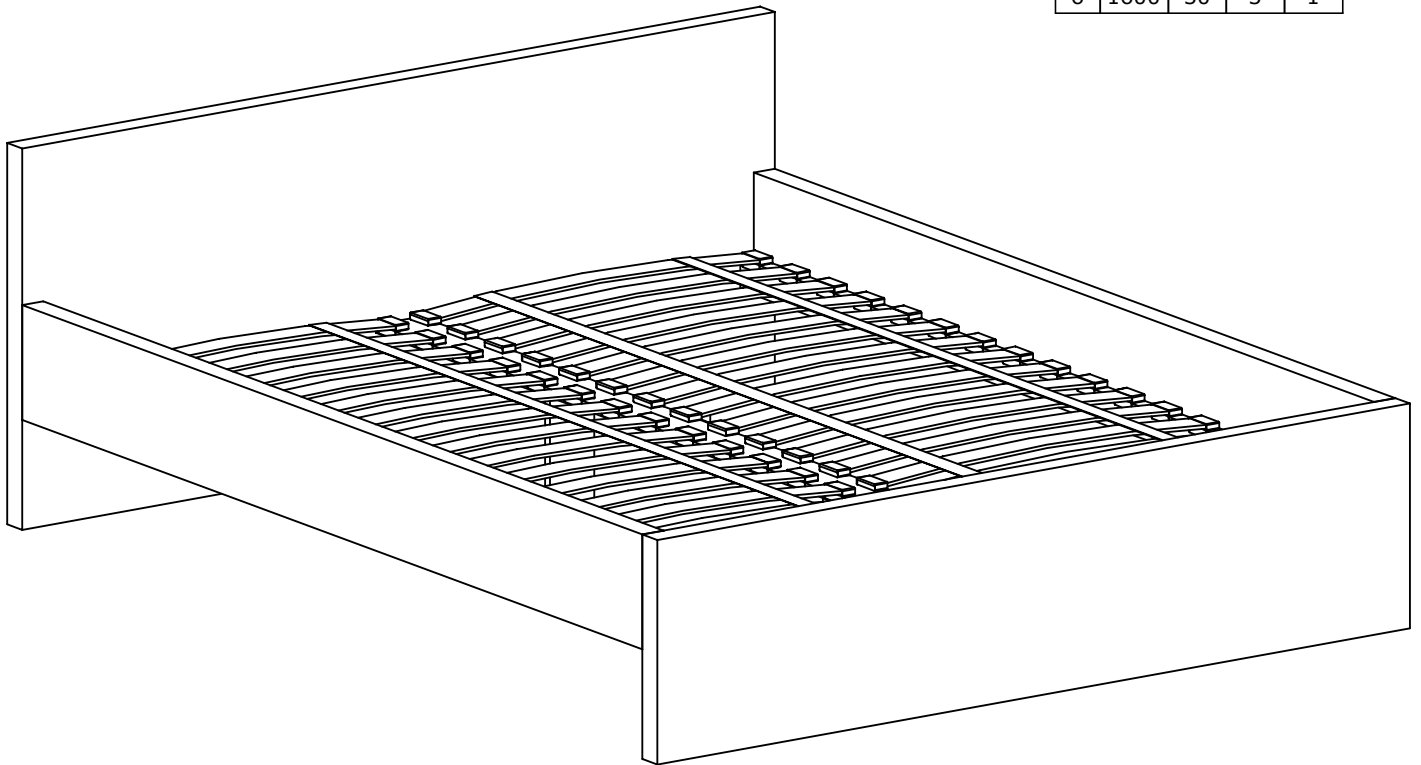

W przypadku reklamacji proszę podać numer pakowacza znajdujący się na kartonie.

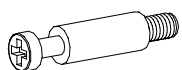

**K - 4 St.**



**L - 4 St.**

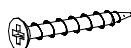

**H - 4 St.**  
3,9x30 mm

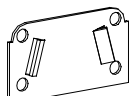

**C - 2 St.**

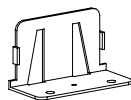

**D - 2 St.**

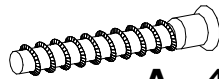

**A - 4 St.**  
7x50 mm



**E - 14 St.**  
4x25 mm

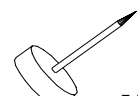

**N - 14 St.**

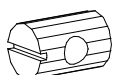

**W - 4 St.**



**B - 8 St.**

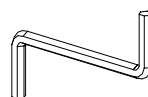

**Z - 1 St.**

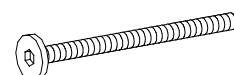

**S - 4 St.**

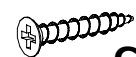

**G - 12 St.**  
4x35 mm

I

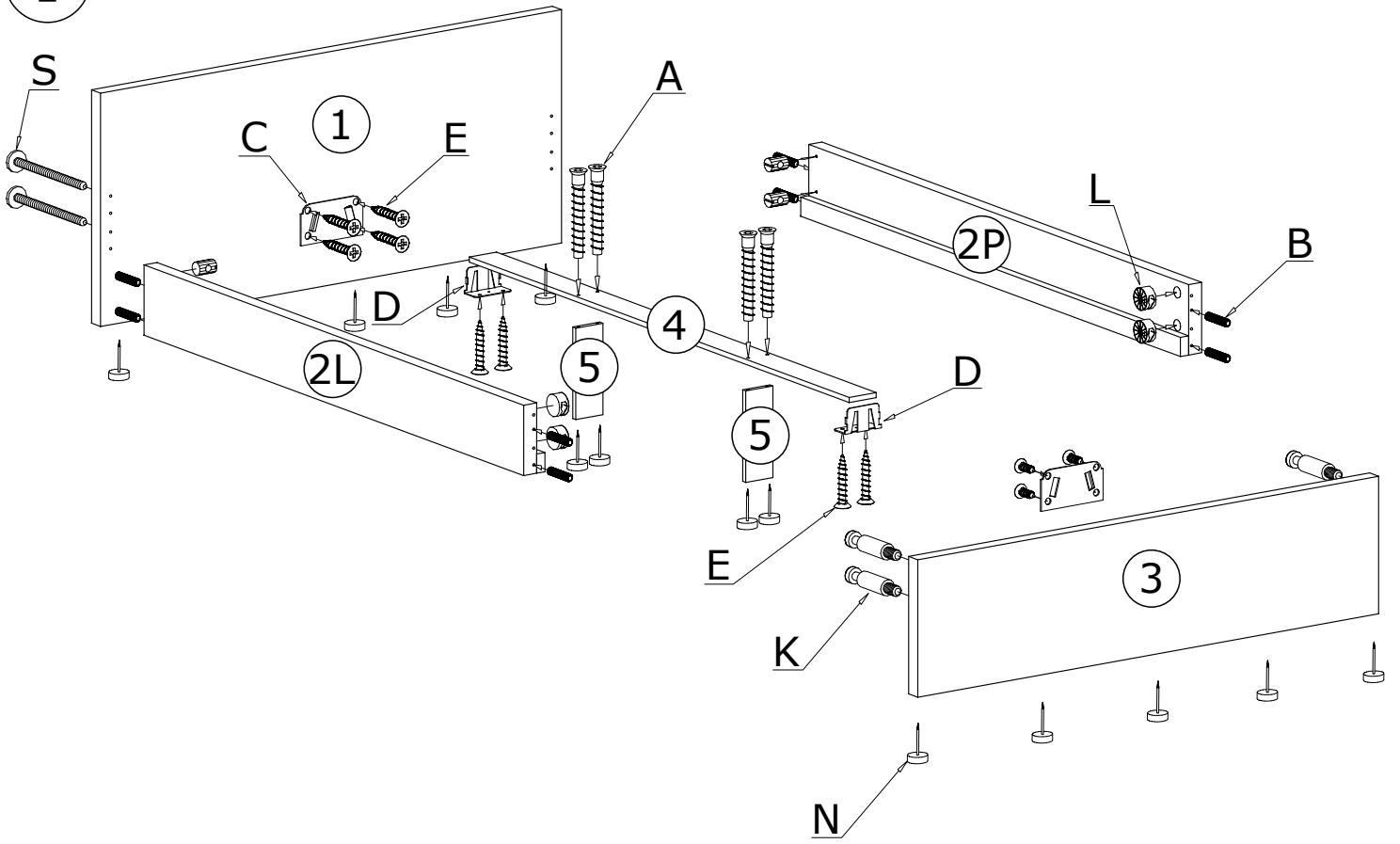

II

