

ORLANDO 9

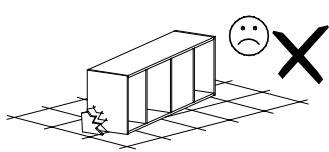

Narzędzia potrzebne do montażu

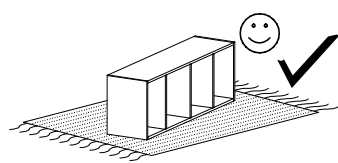

UWAGA !!!

MONTOWANIE USZKODZONYCH
ELEMENTÓW POWODUJE UTRATĘ
GWARANCJI

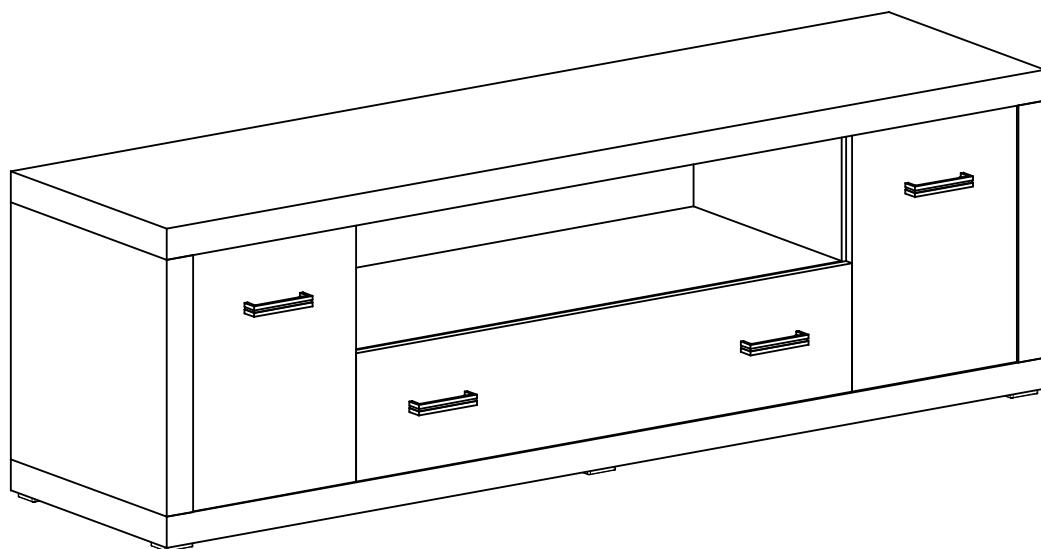

Nr	D[mm]	S[mm]	G[mm]	Ilość
1	1600	407	48	1
2	1600	407	48	1
3	400	405	48	1
4	400	388	16	1
5	400	388	16	1
6	400	405	48	1
7	342	320	16	2
8	845	388	16	1
9	1590	458	2,5	1
10	392	316	16	1
11	392	316	16	1
12	856	190	16	1
13	350	165	16	1
14	350	165	16	1
15	790	165	16	1
16	820	355	2,5	1

W przypadku reklamacji proszę podać numer pakowacza znajdujący się na kartonie.

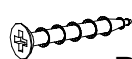

P - 12 St.
3,9x25 mm

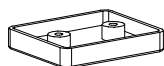

W - 6 St.

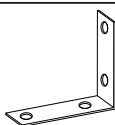

Y - 2 St.

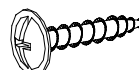

Q - 4 St.
3,5x16 mm



X1 - 2 St.



S - 1 St.

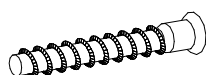

Y - 4 St.

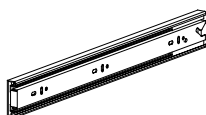

T - 1 Kpl.

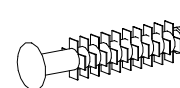

F - 4 St.

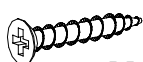

M - 14 St.
3x30 mm



J - 8 St.
5x13 mm

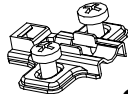

C1 - 2 St.

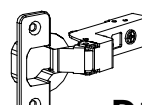

D1 - 2 St.



L - 18 St.

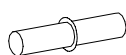

R - 8 St.

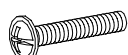

N - 8 St.
5x25 mm

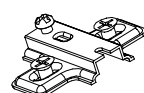

C2 - 2 St.

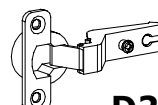

D2 - 2 St.



G - 8 St.
3,5x16 mm



E - 50 St.



B - 20 St.

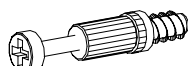

K - 18 St.

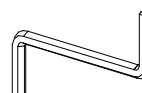

Z - 1 St.

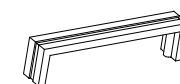

U - 4 St.

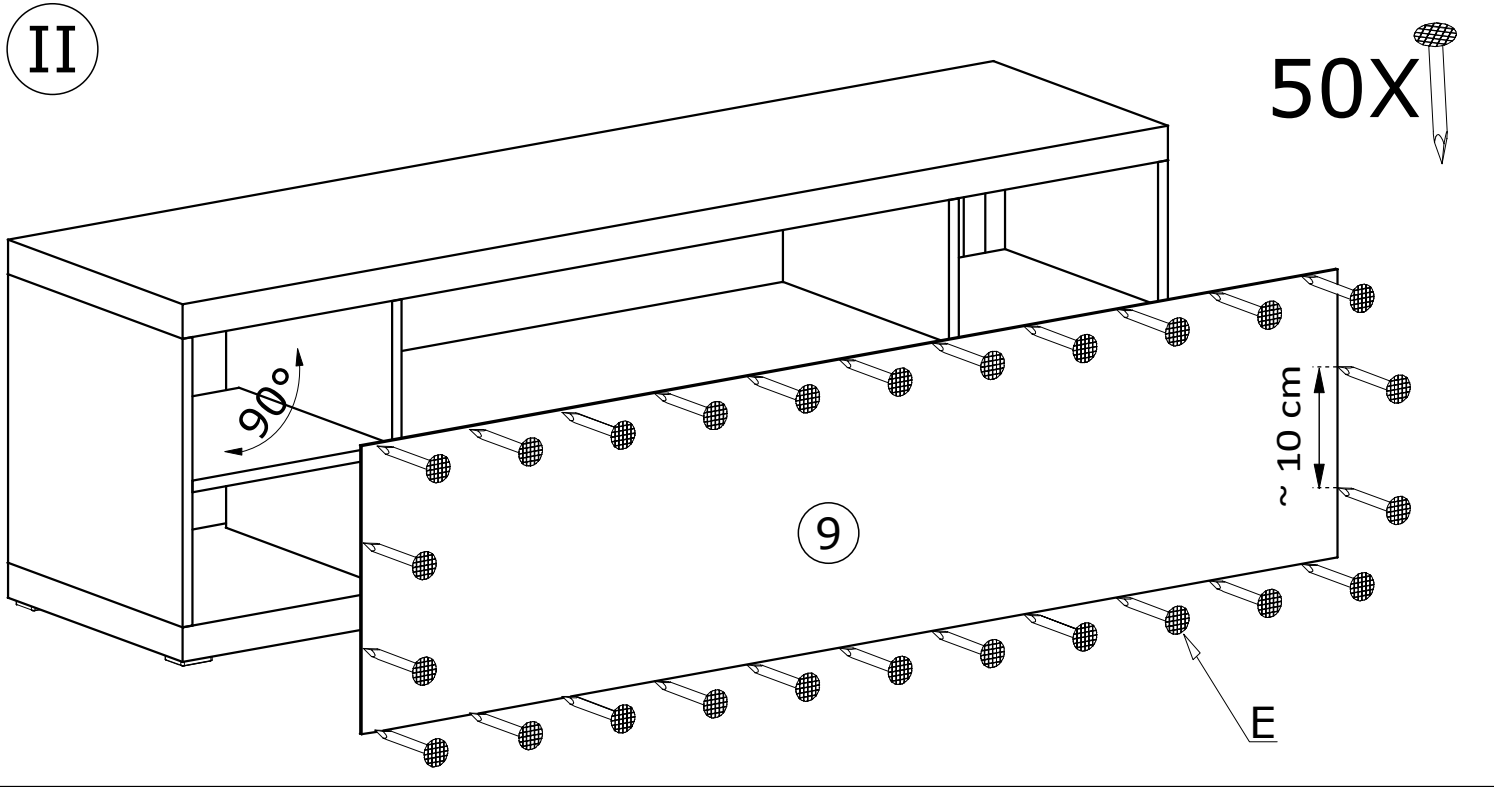
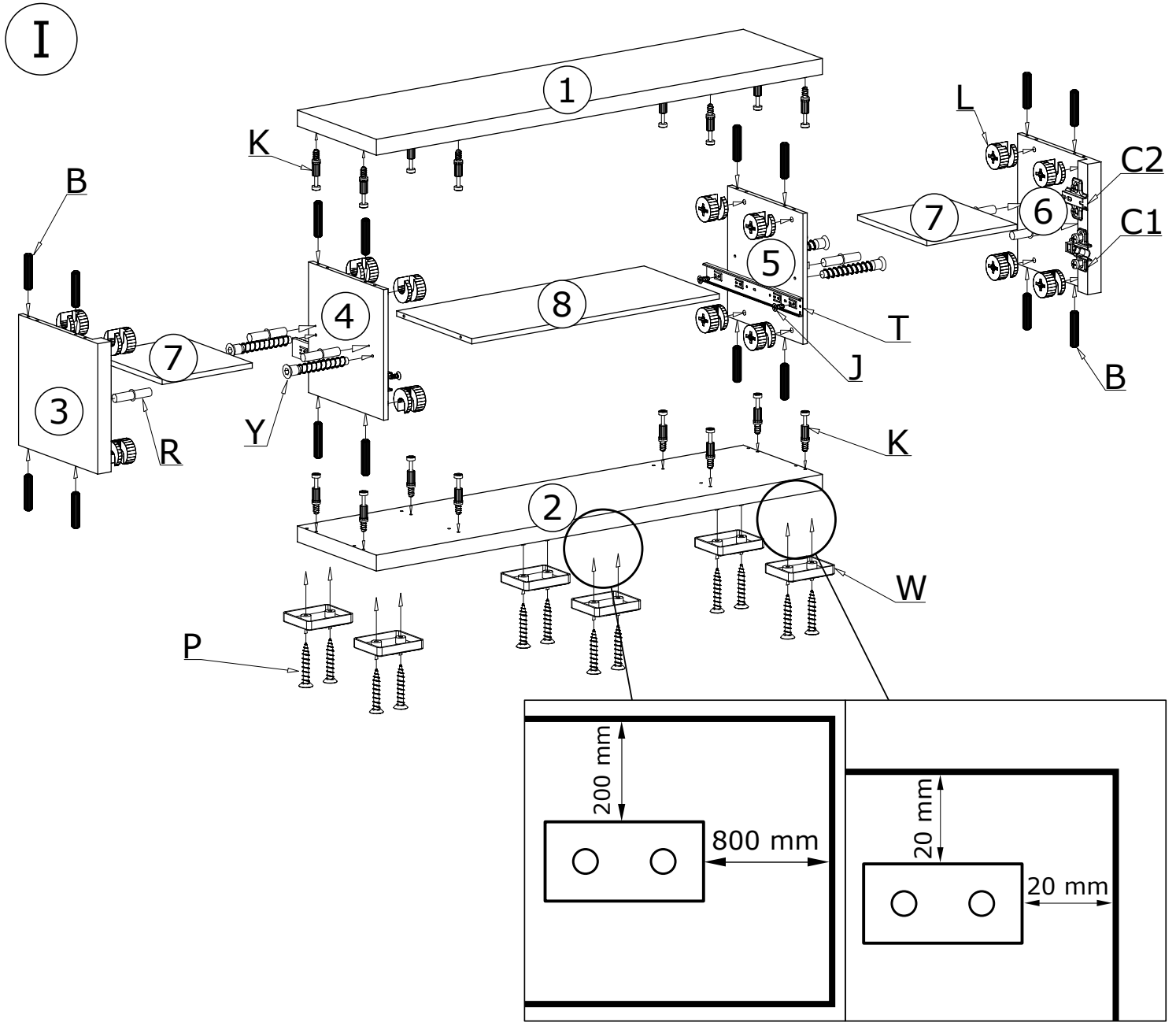

III

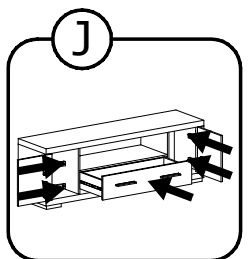
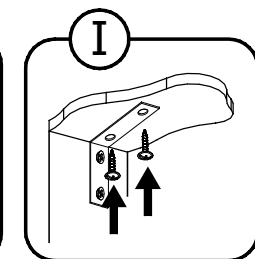
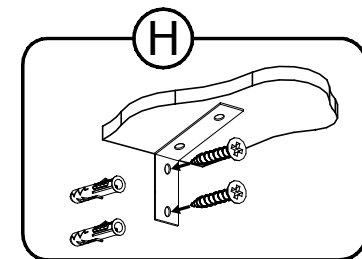
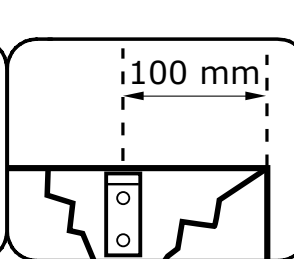
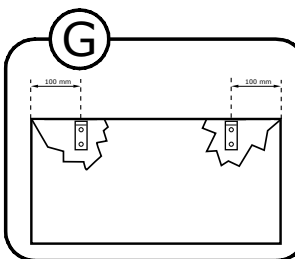
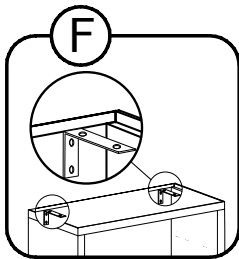
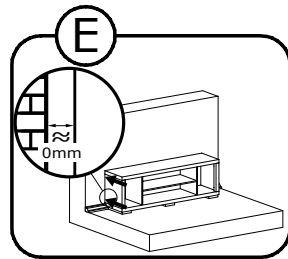
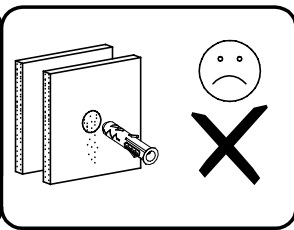
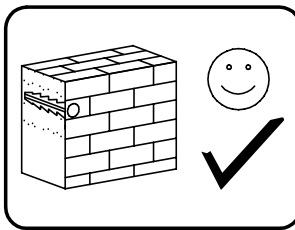
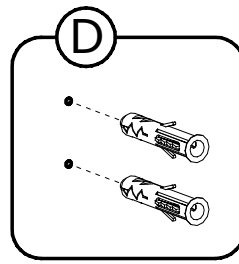
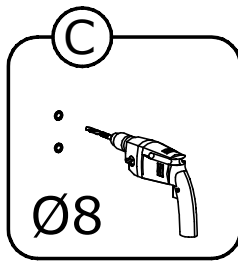
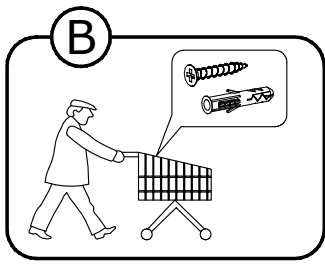
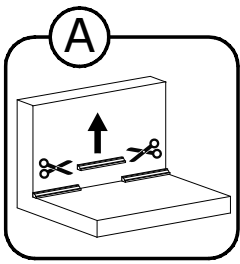
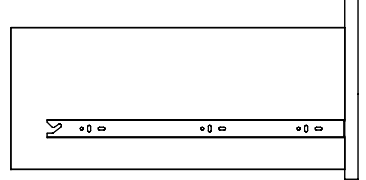
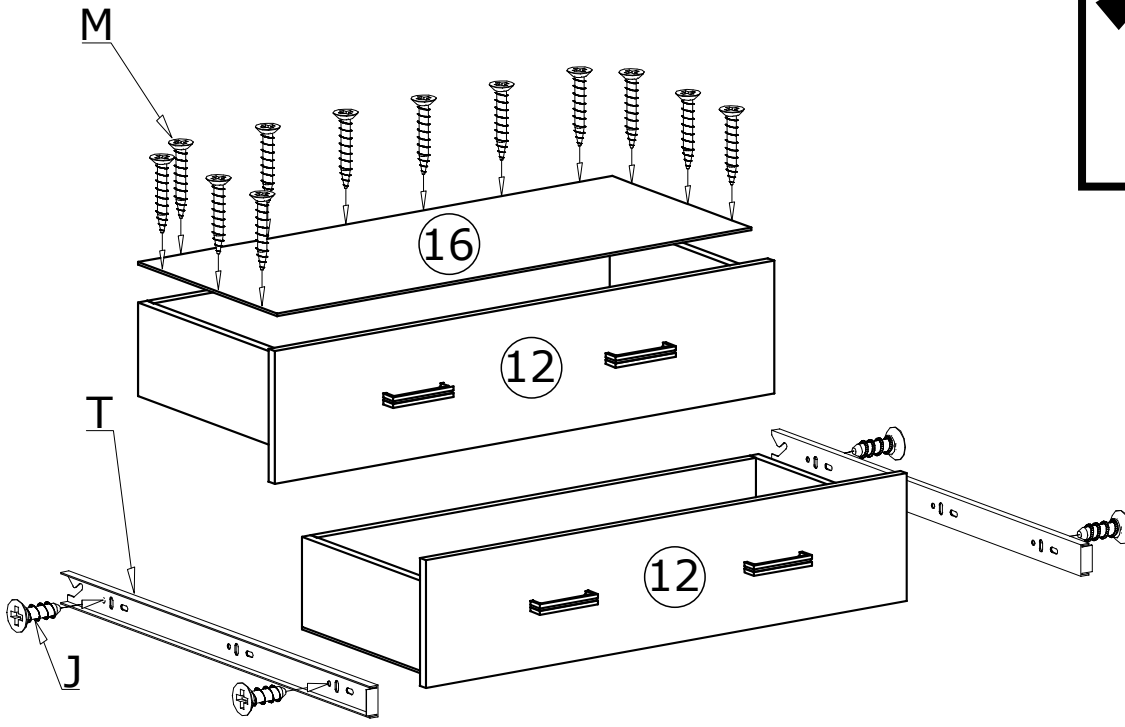
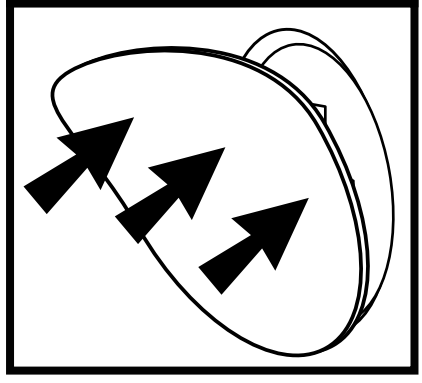
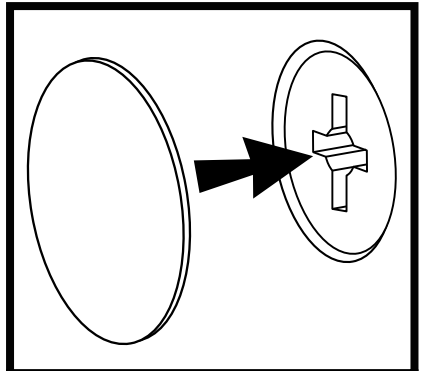
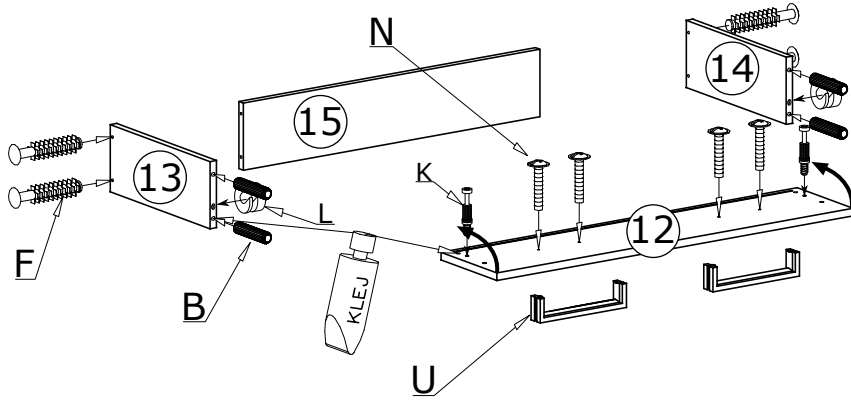

IV

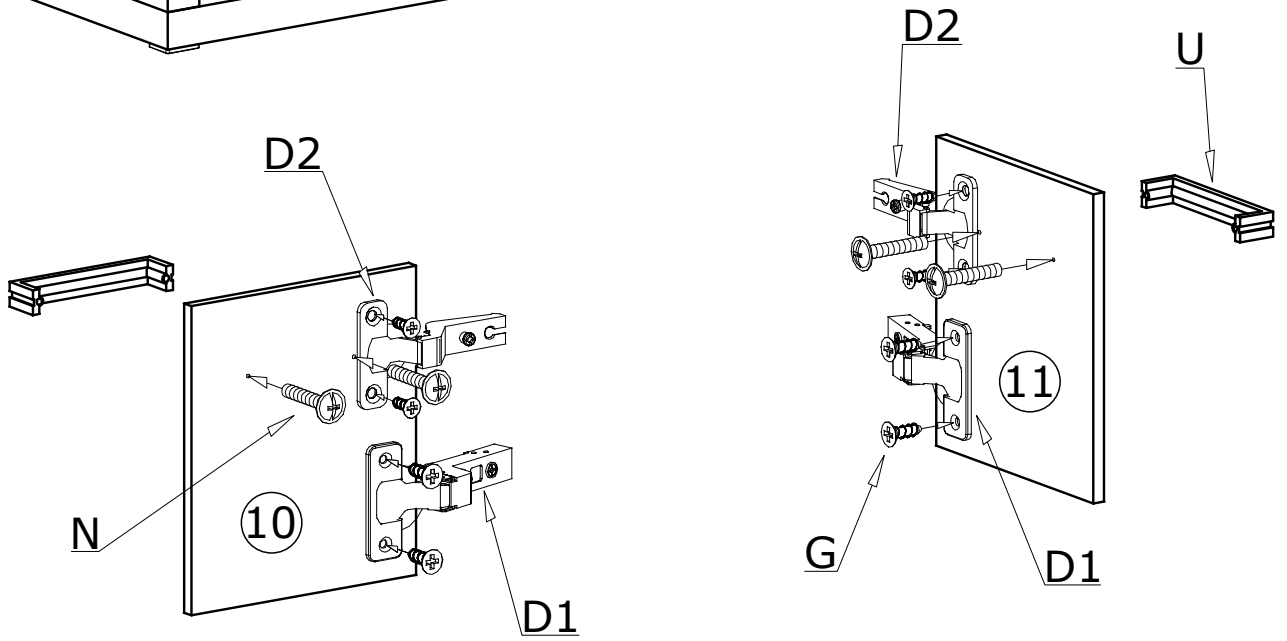
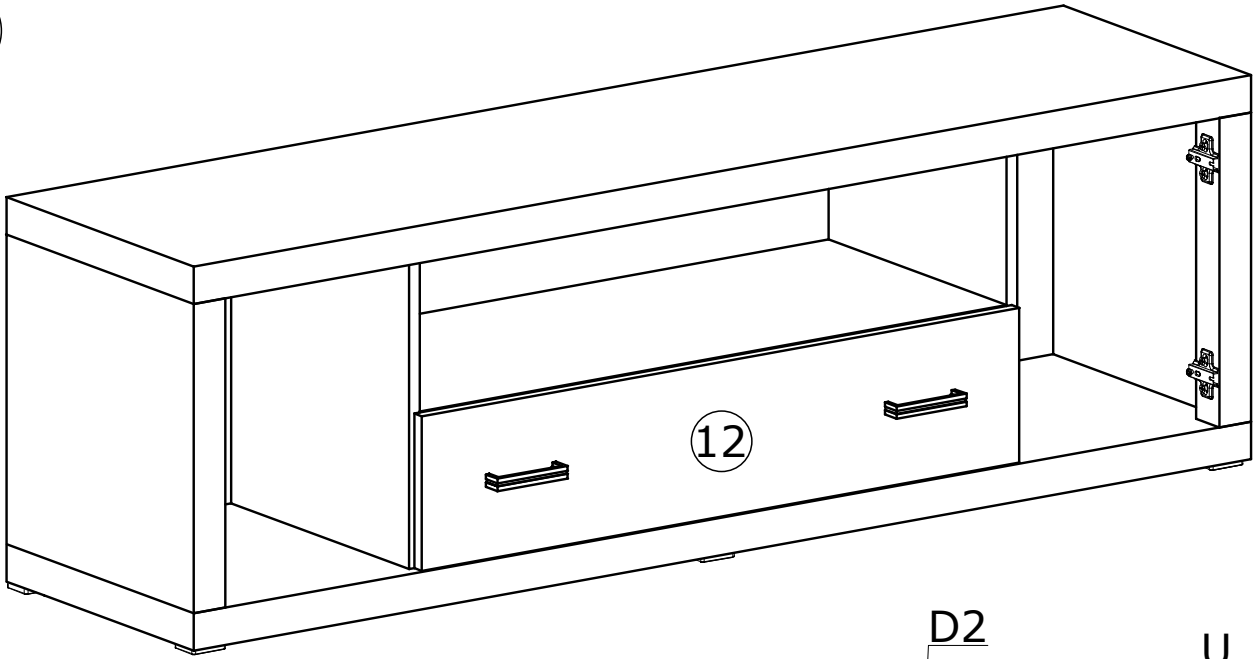

MONTAŻ/DEMONTAŻ PROWADNIC

1



2

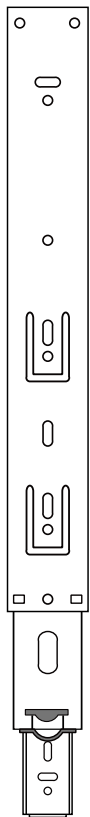

3

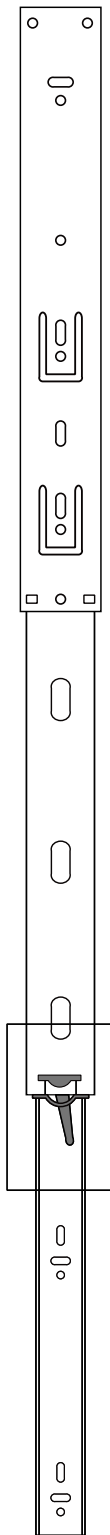

4

