

# ORLANDO 8

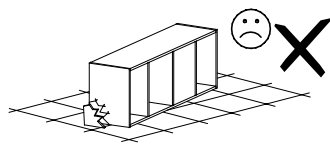

Narzędzia potrzebne do montażu

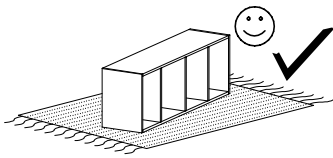
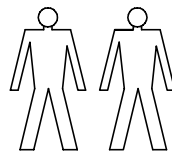
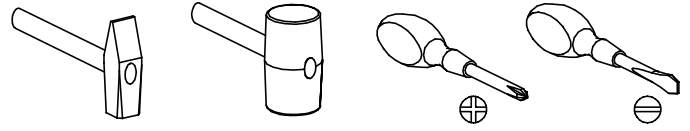

## UWAGA !!!

MONTOWANIE USZKODZONYCH  
ELEMENTÓW POWODUJE UTRATĘ  
GWARANCJI

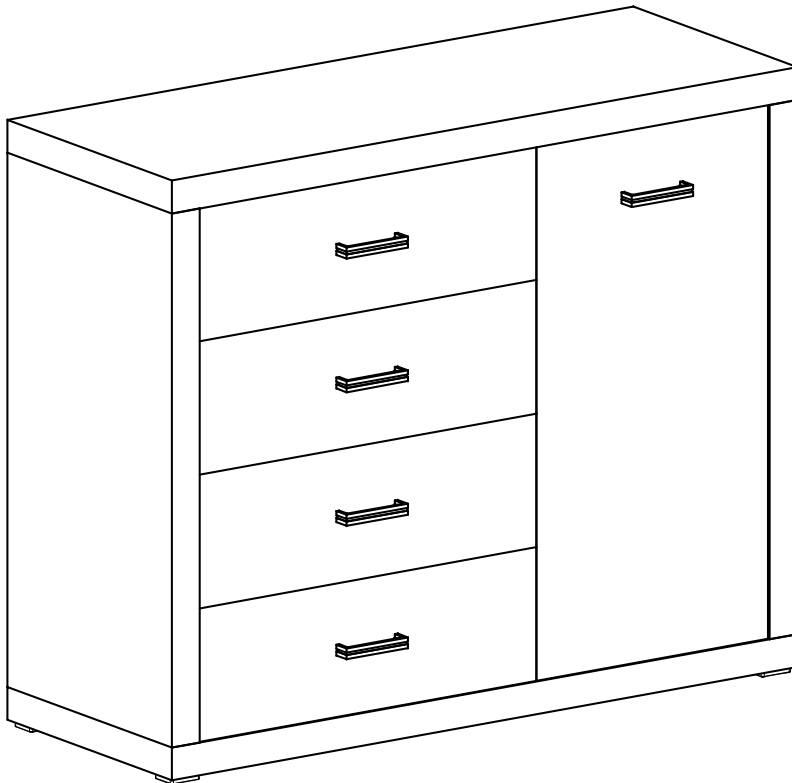

Nr	D[mm]	S[mm]	G[mm]	Ilość
1	1080	405	48	1
2	1080	405	48	1
3	780	405	48	1
4	780	388	16	1
5	780	405	48	1
6	394	320	16	1
7	773	368	16	1
8	1070	834	2,5	1
9	603	190	16	4
10	544	165	16	4
11	350	165	16	4
12	350	165	16	4
13	575	355	2,5	4

W przypadku reklamacji proszę podać numer pakowacza znajdujący się na kartonie.

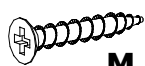

**M - 65 St.**  
3x30 mm

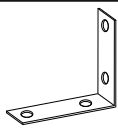

**Y - 2 St.**

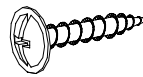

**I - 4 St.**  
3,5x16 mm



**X - 8 St.**

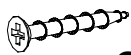

**Q - 10 St.**  
3,9x25 mm

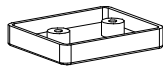

**W - 5 St.**

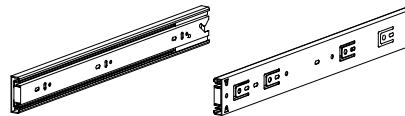

**T - 4 Kpl.**

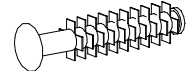

**F - 16 St.**

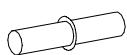

**P - 4 St.**

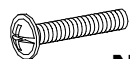

**N - 10 St.**  
4x25 mm



**C1 - 1 St.**

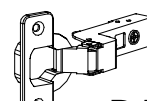

**D1 - 1 St.**



**L - 20 St.**

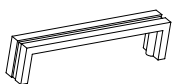

**U - 5 St.**



**G - 4 St.**  
3,5x16 mm

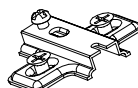

**C2 - 1 St.**

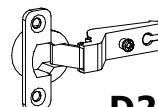

**D2 - 1 St.**



**S - 1 St.**



**E - 60 St.**



**B - 28 St.**

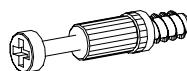

**K - 20 St.**

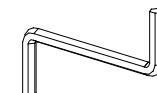

**Z - 1 St.**



**J - 32 St.**  
5x13 mm

I

1

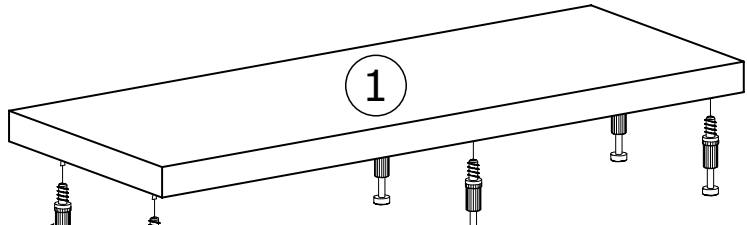

K

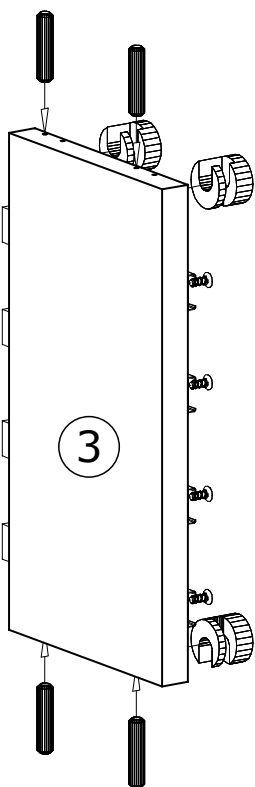

3

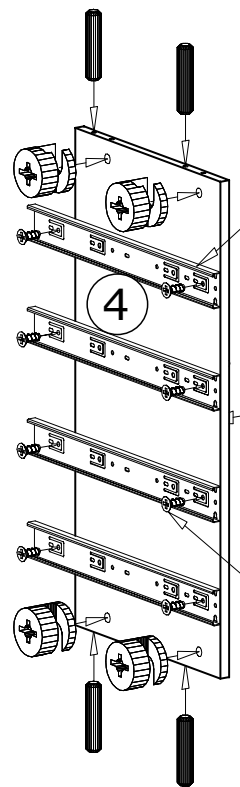

4

T

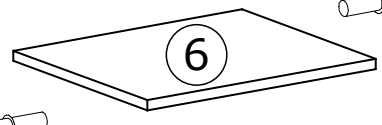

6

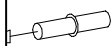

P

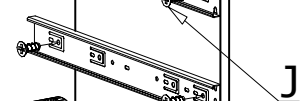

J

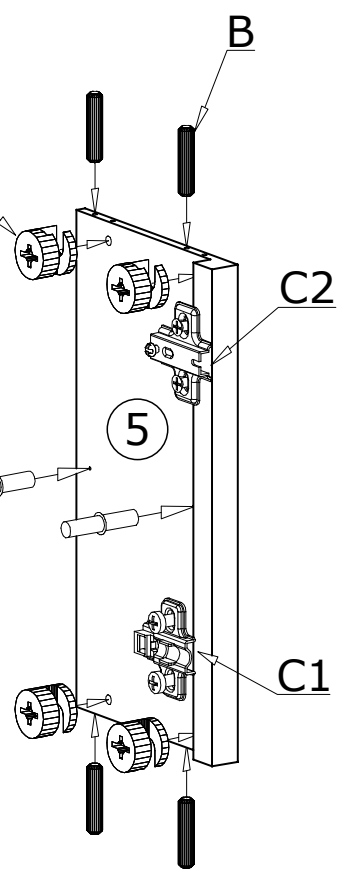

5

B

C2

C1

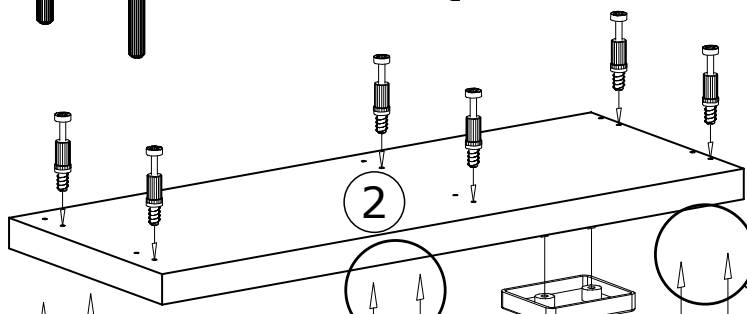

2

W

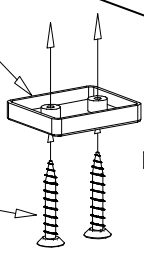

Q

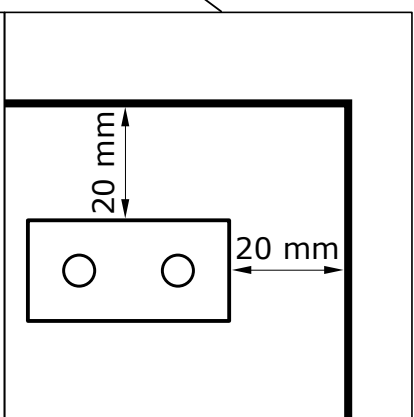
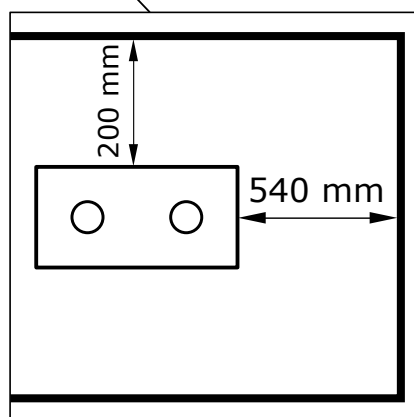
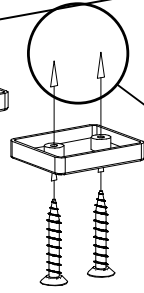
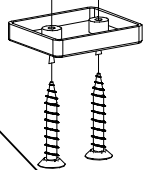
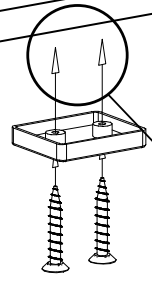
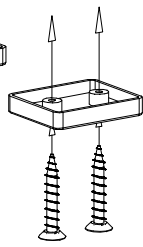

II

60X 

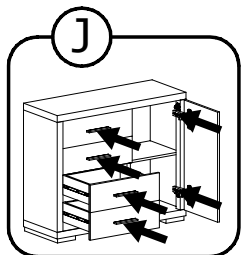
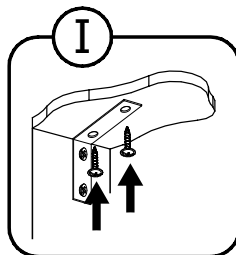
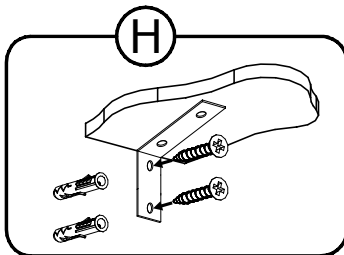
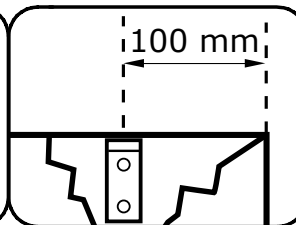
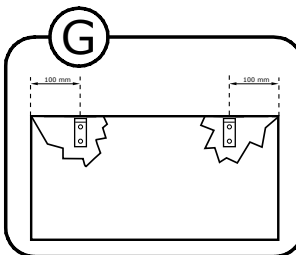
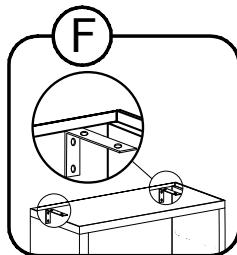
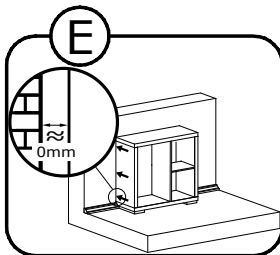
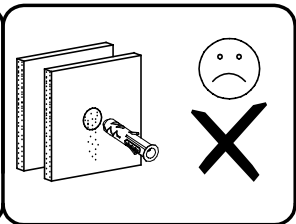
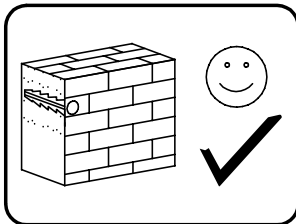
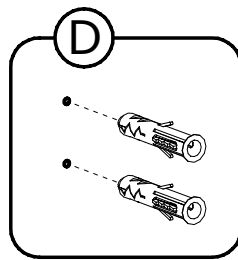
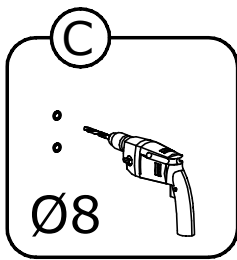
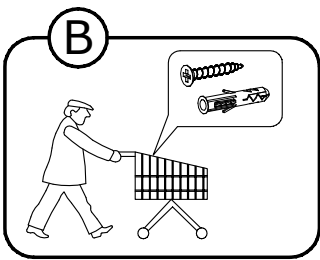
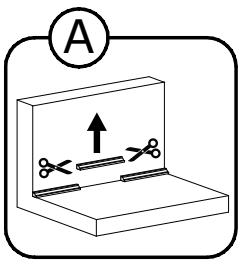
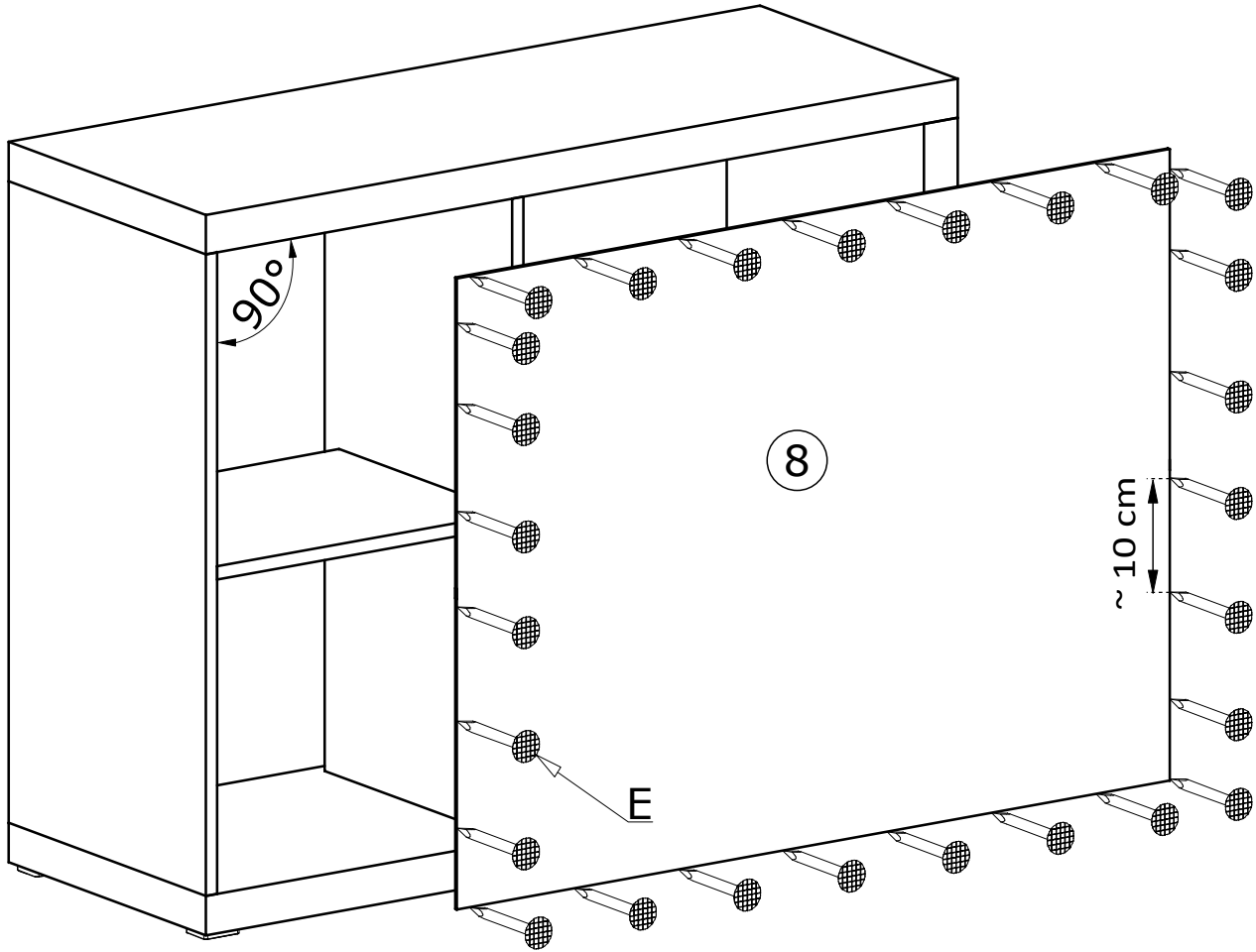

III

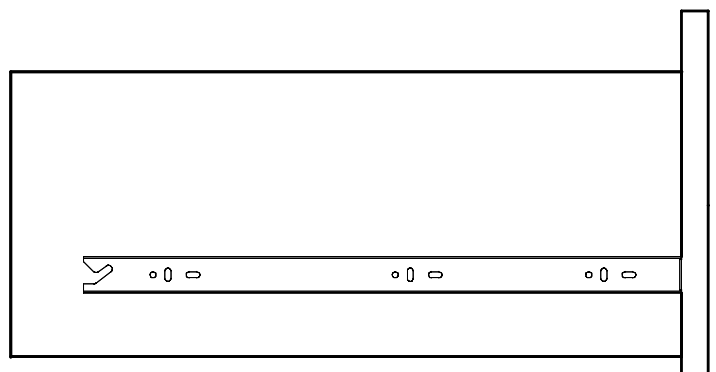
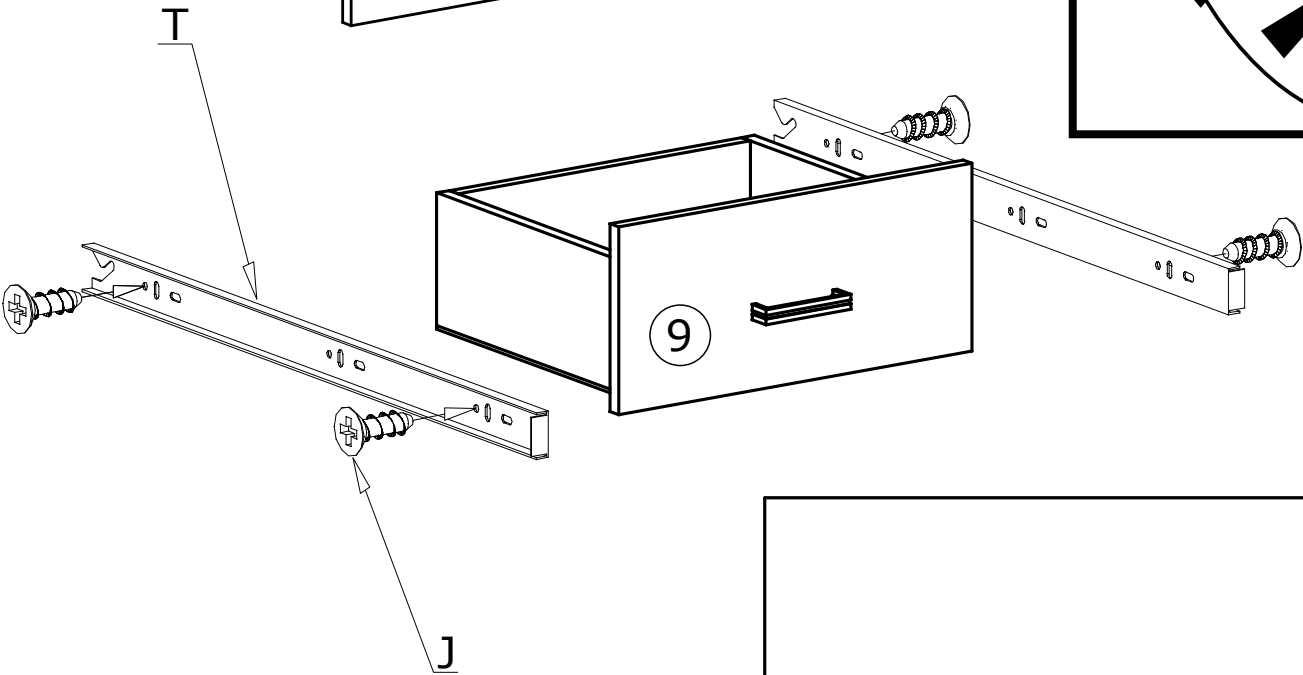
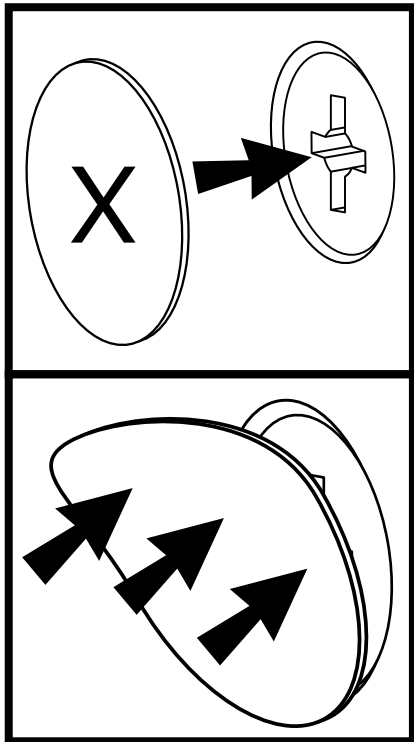
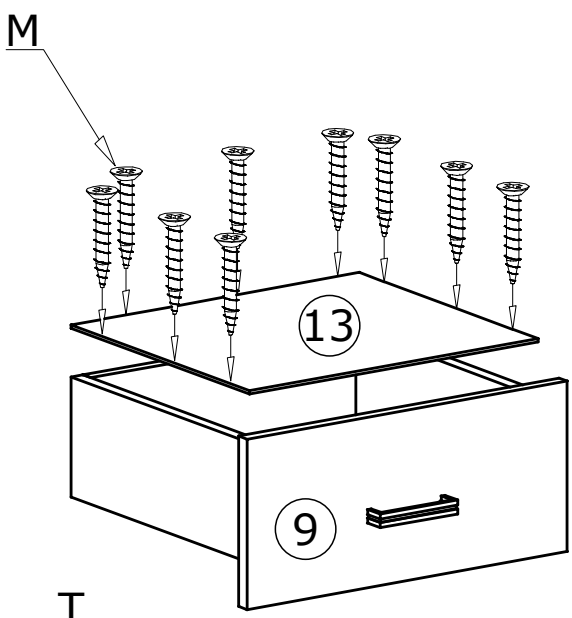
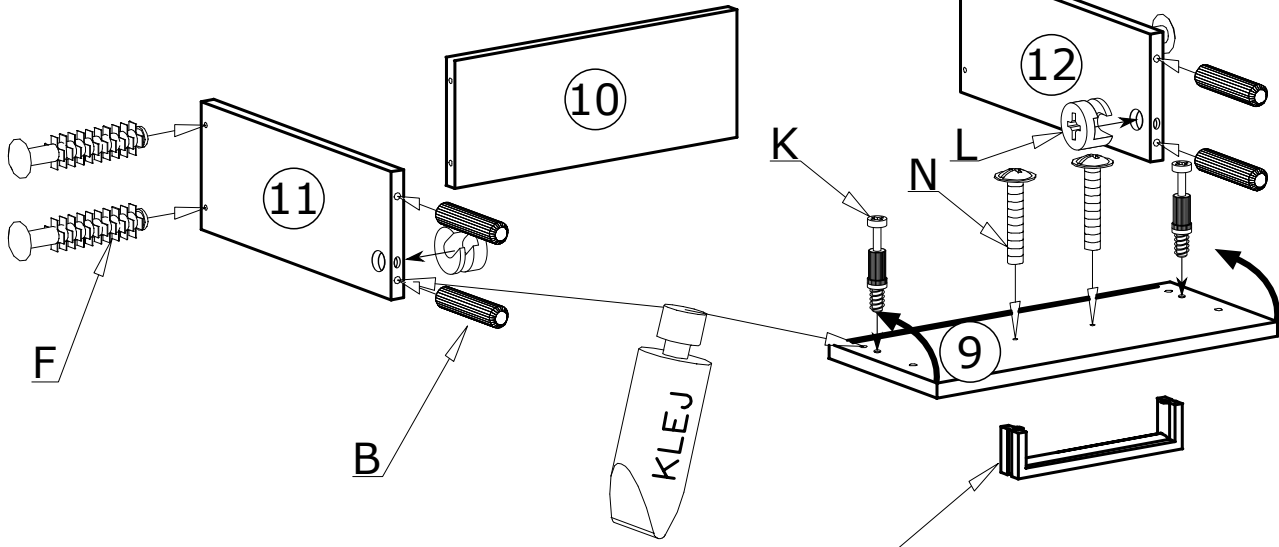

IV

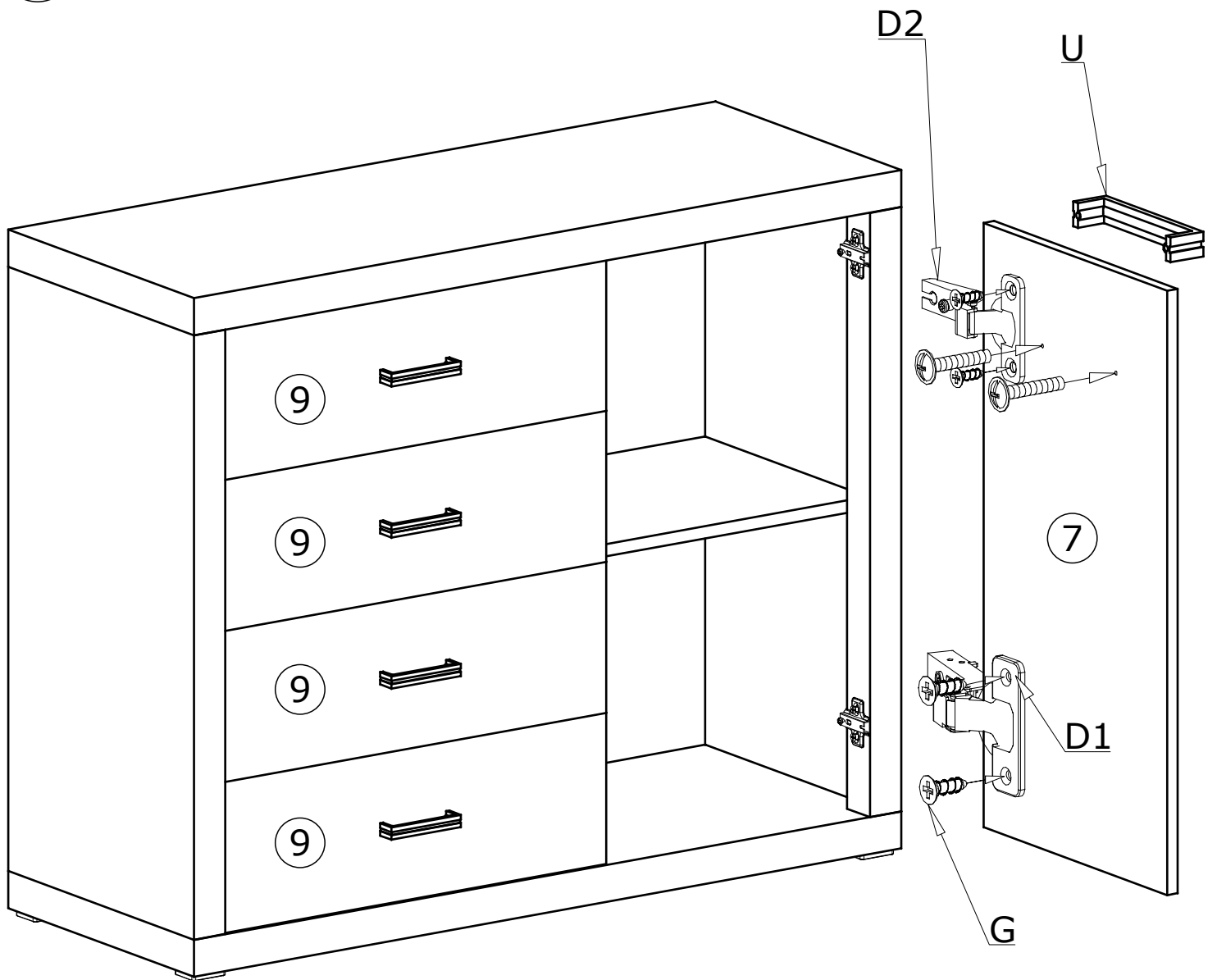

# MONTAŻ/DEMONTAŻ PROWADNIC

1

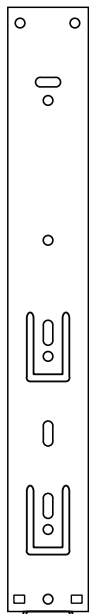

2

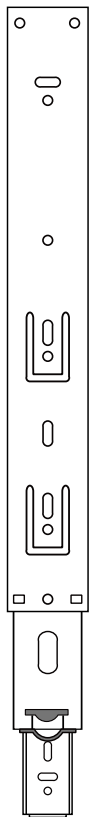

3

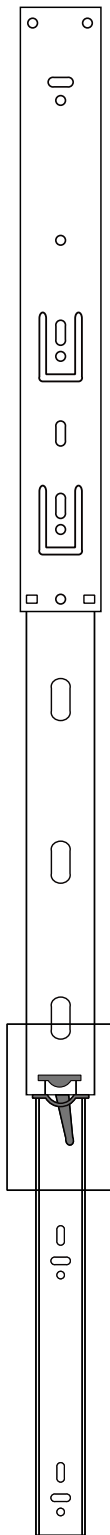

4

