

ORLANDO 7

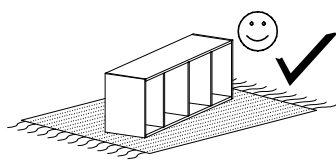

Narzędzia potrzebne do montażu

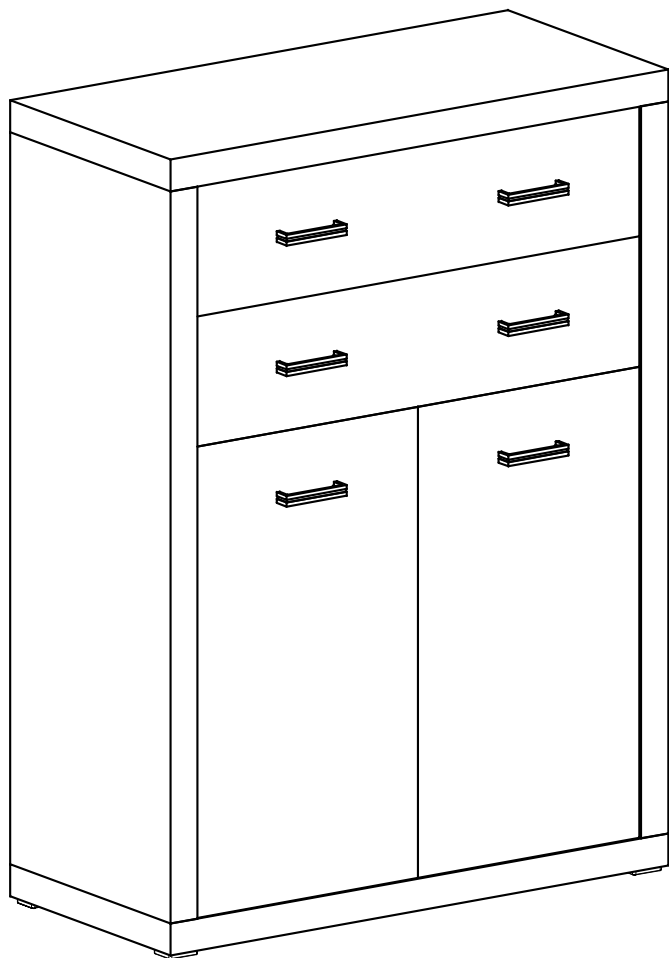

UWAGA !!!

MONTOWANIE USZKODZONYCH
ELEMENTÓW POWODUJE UTRATĘ
GWARANCJI

Nr	D[mm]	S[mm]	G[mm]	Ilość
1	883	407	48	1
2	883	407	48	1
3	1098	405	48	1
4	1098	405	48	1
5	850	388	16	1
6	780	190	16	2
7	350	165	16	2
8	726	165	16	2
9	350	165	16	2
10	758	355	2,5	2
11	870	784	2,5	1
12	700	390	16	1
13	700	390	16	1
14	870	360	2,5	1

W przypadku reklamacji proszę podać numer pakowacza znajdujący się na kartonie.

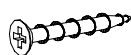

P - 8 St.
3,9x25 mm



Y - 2 St.

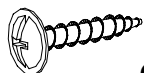

Q - 4 St.
3,5x16 mm



M - 40 St.
3x30 mm

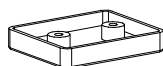

W - 4 St.

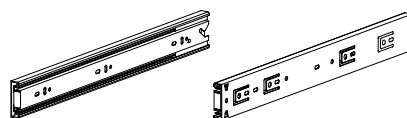

T - 2 Kpl.

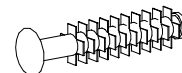

F - 8 St.



A - 6 St.

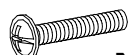

N - 12 St.
5x25 mm

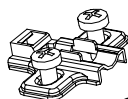

C1 - 2 St.

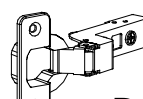

D1 - 2 St.



L - 12 St.

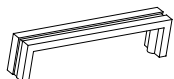

U - 6 St.

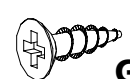

G - 14 St.
3,5x16 mm

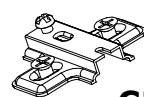

C2 - 2 St.

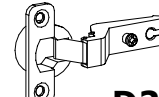

D2 - 2 St.



S - 1 St.



E - 50 St.



B - 20 St.

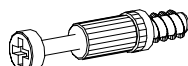

K - 12 St.

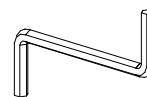

Z - 1 St.



J - 16 St.
5x13 mm

I

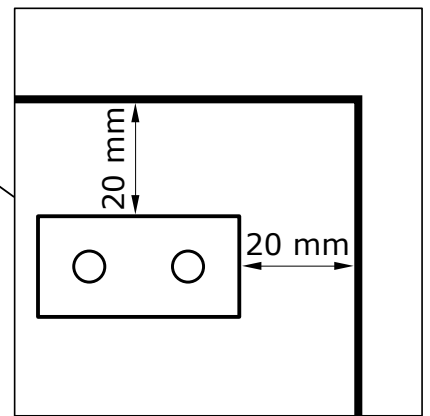
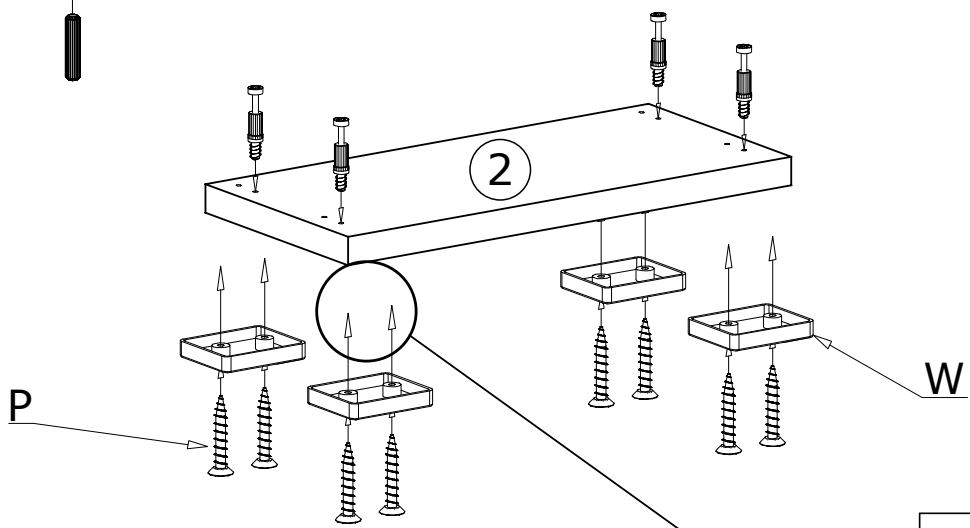
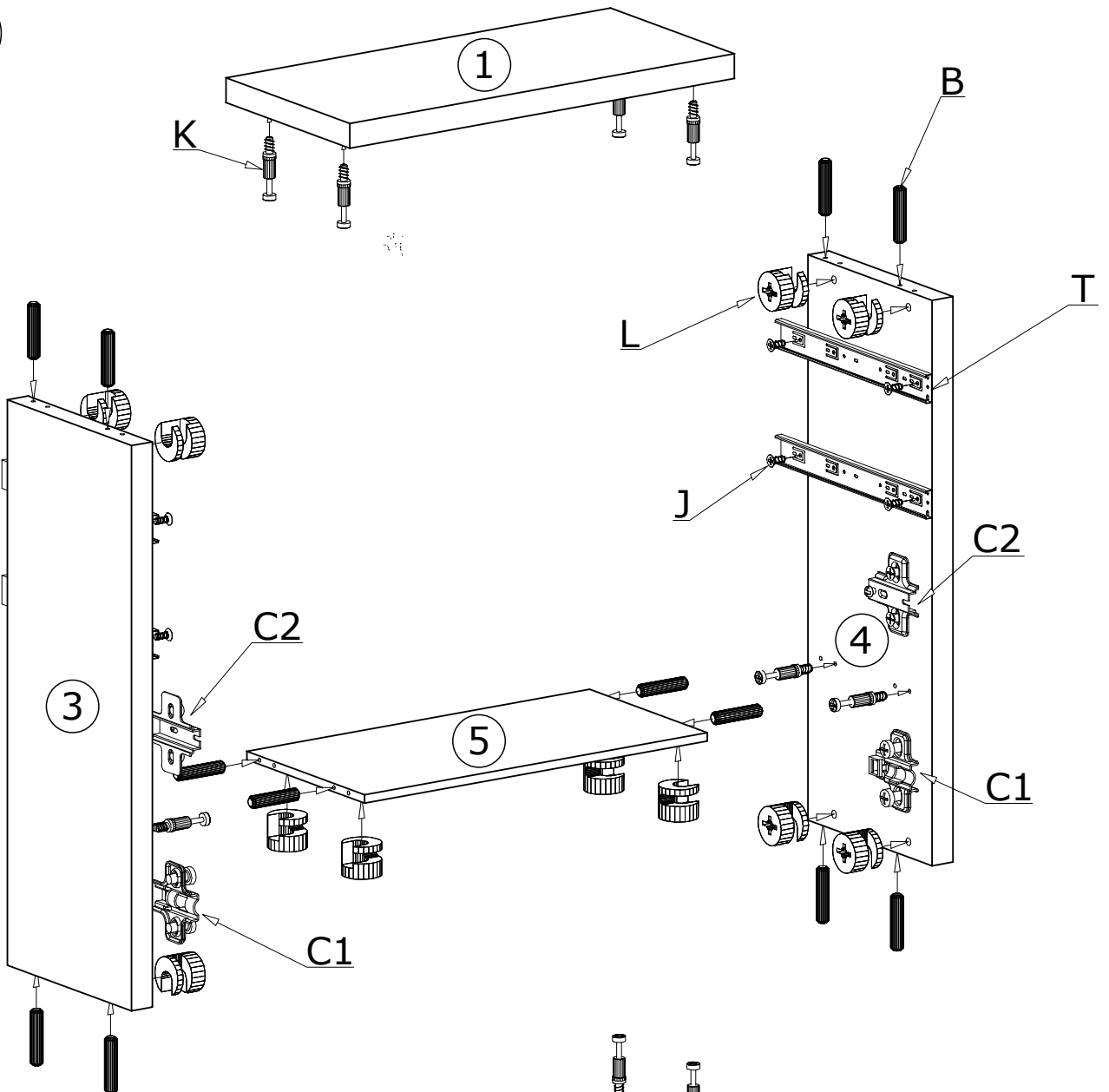

II

50X 

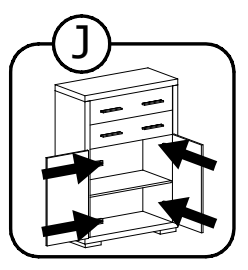
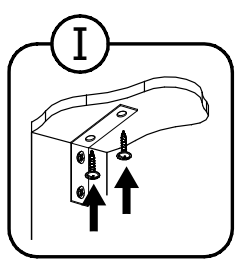
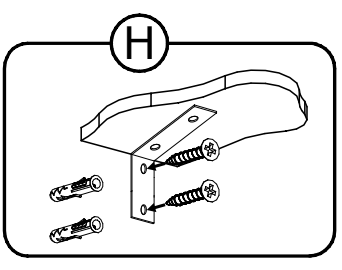
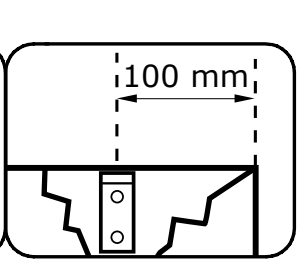
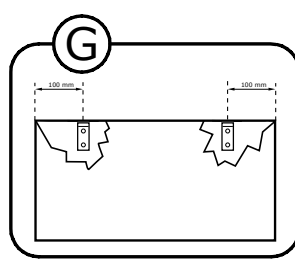
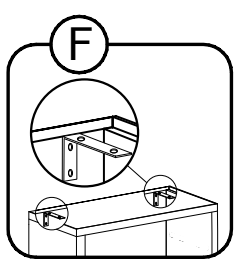
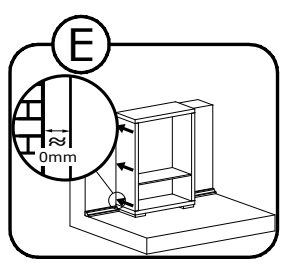
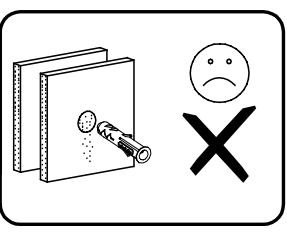
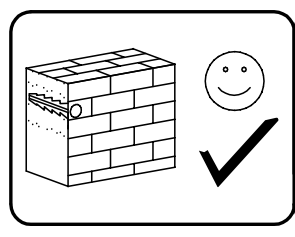
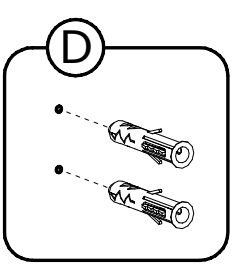
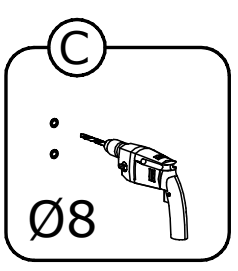
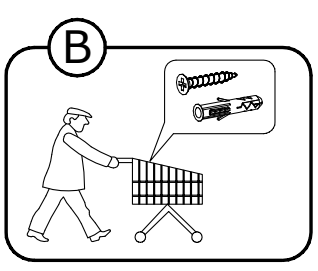
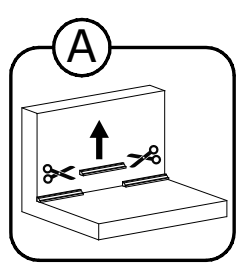
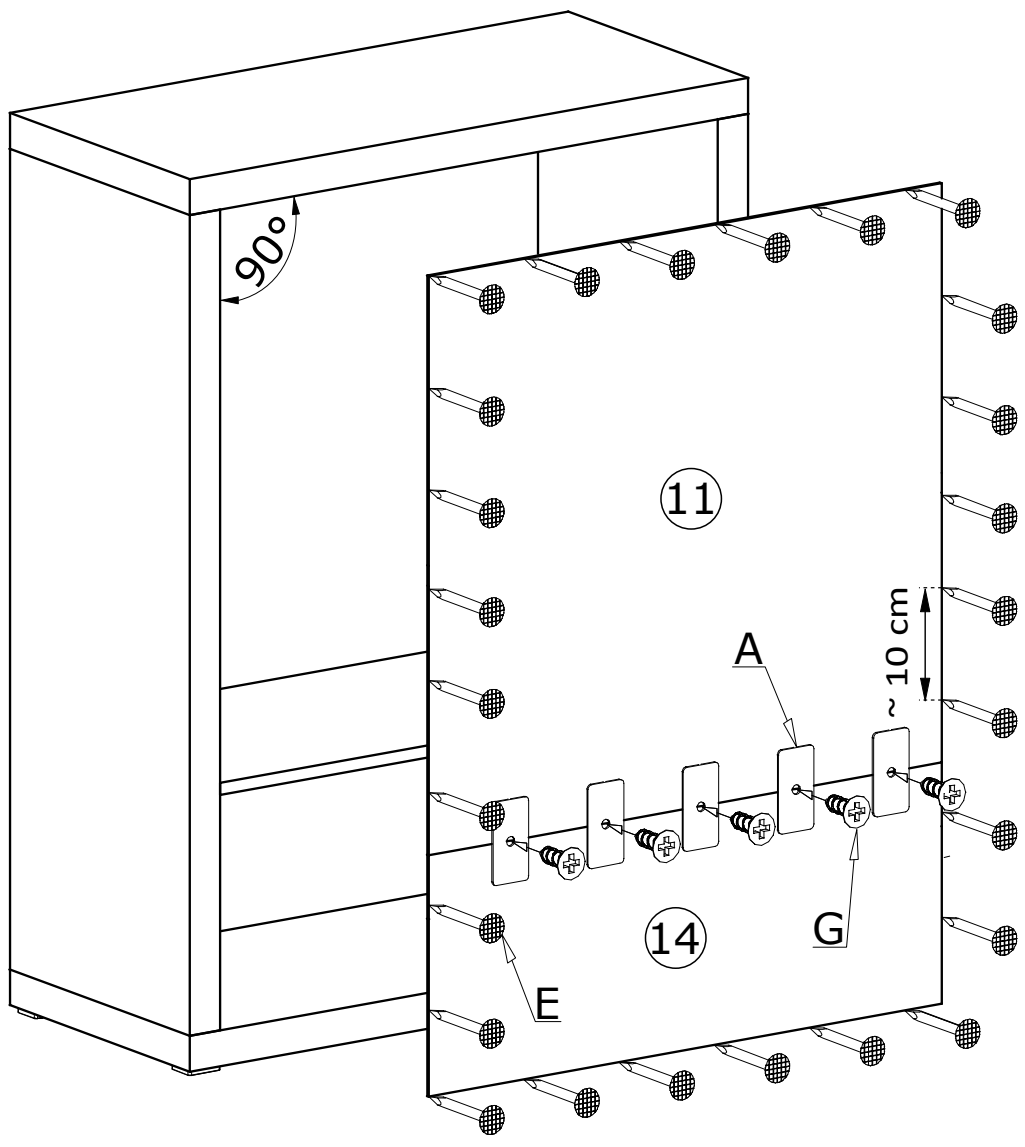

III

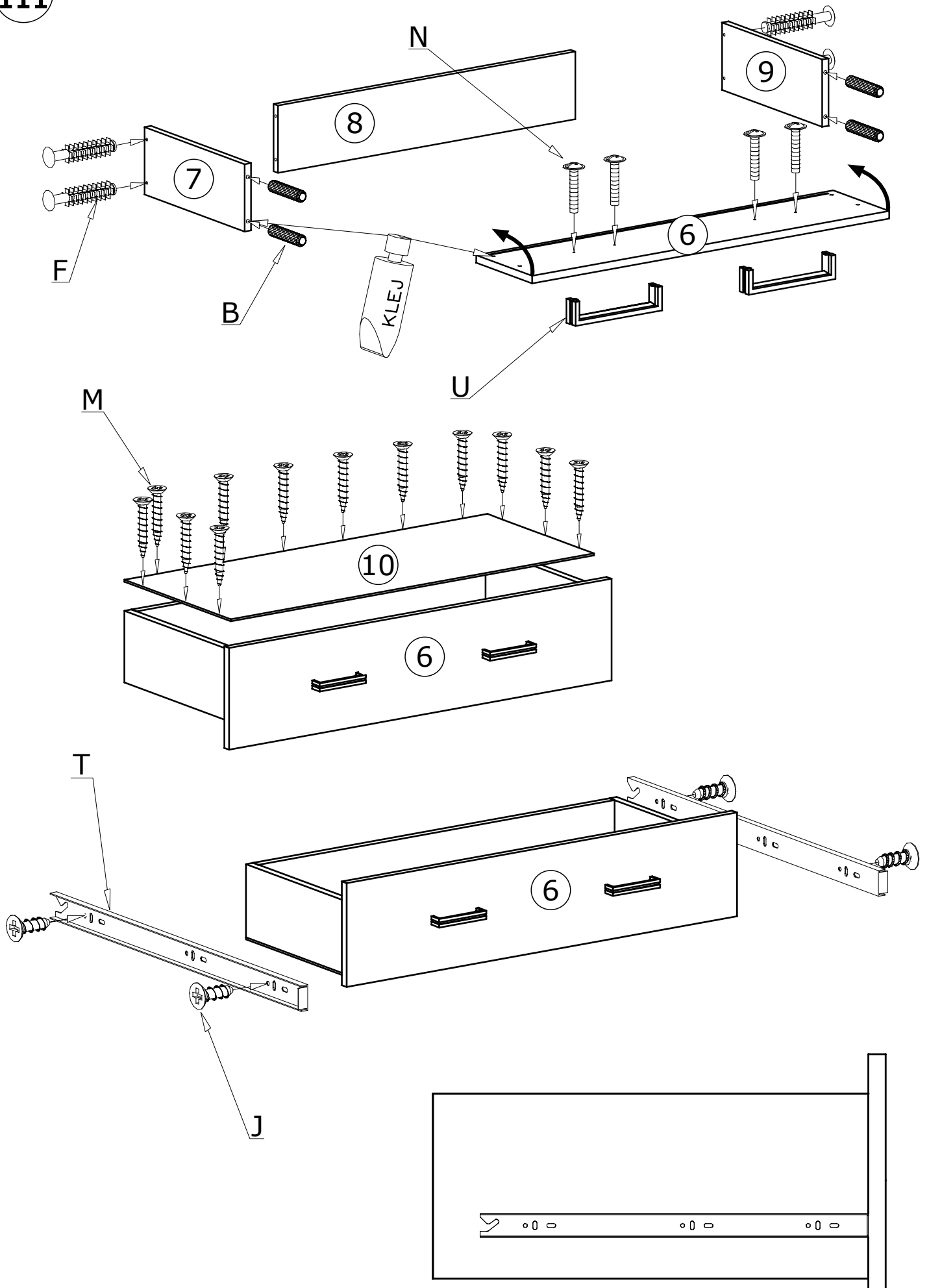

IV

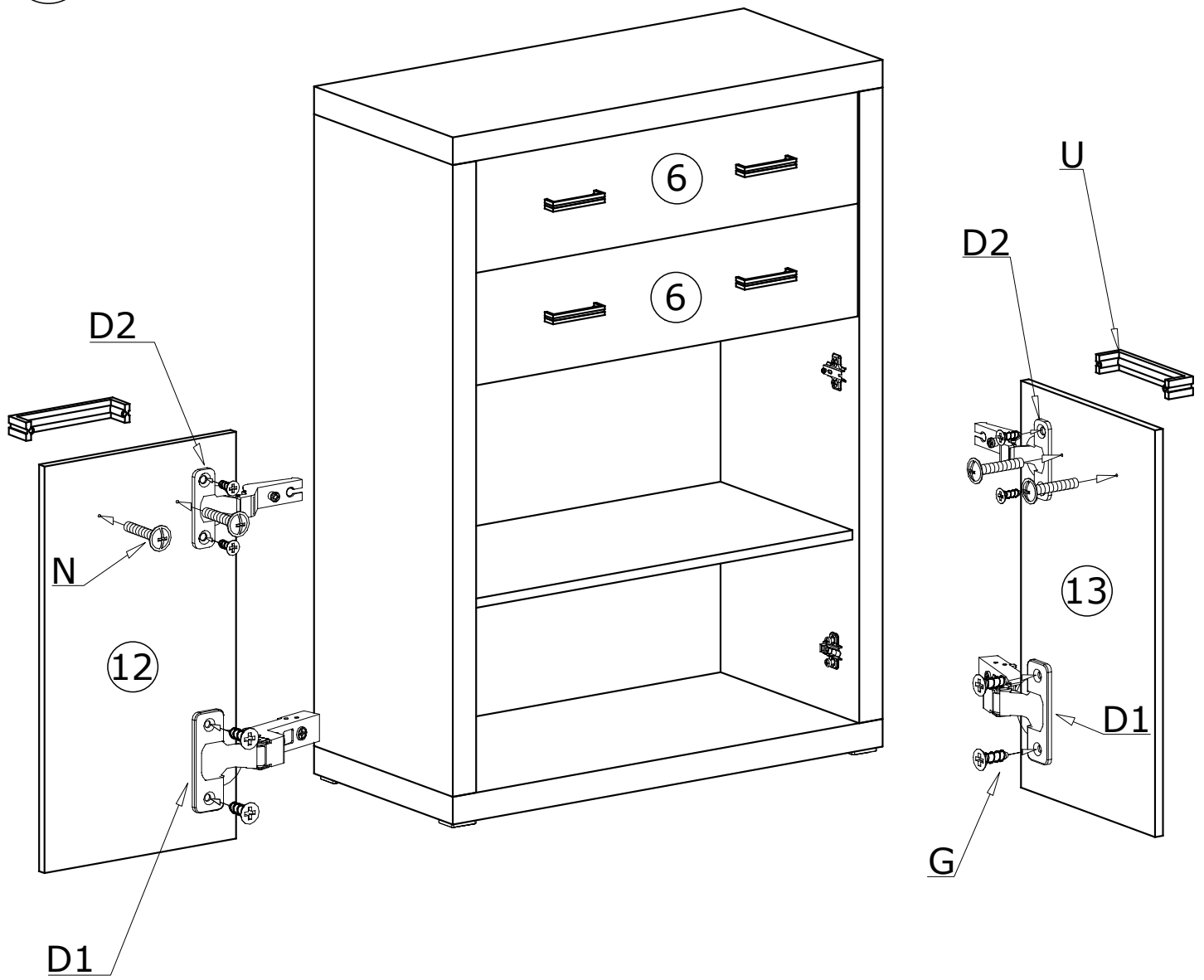

MONTAŻ/DEMONTAŻ PROWADNIC

1

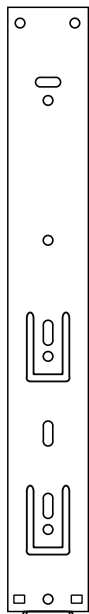

2

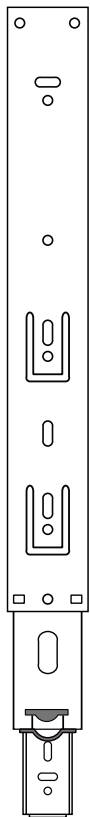

3

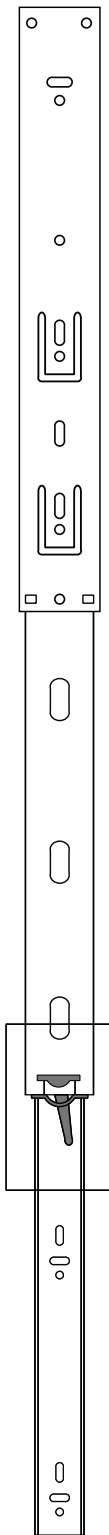

4

