

# ORLANDO 6

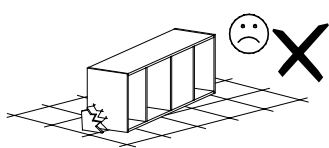

Narzędzia potrzebne do montażu

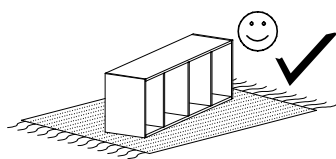
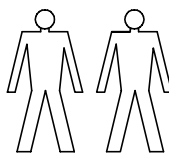
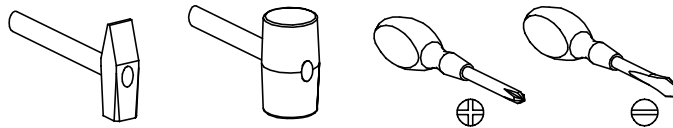

## **UWAGA !!!**

MONTOWANIE USZKODZONYCH  
ELEMENTÓW POWODUJE UTRATĘ  
GWARANCJI

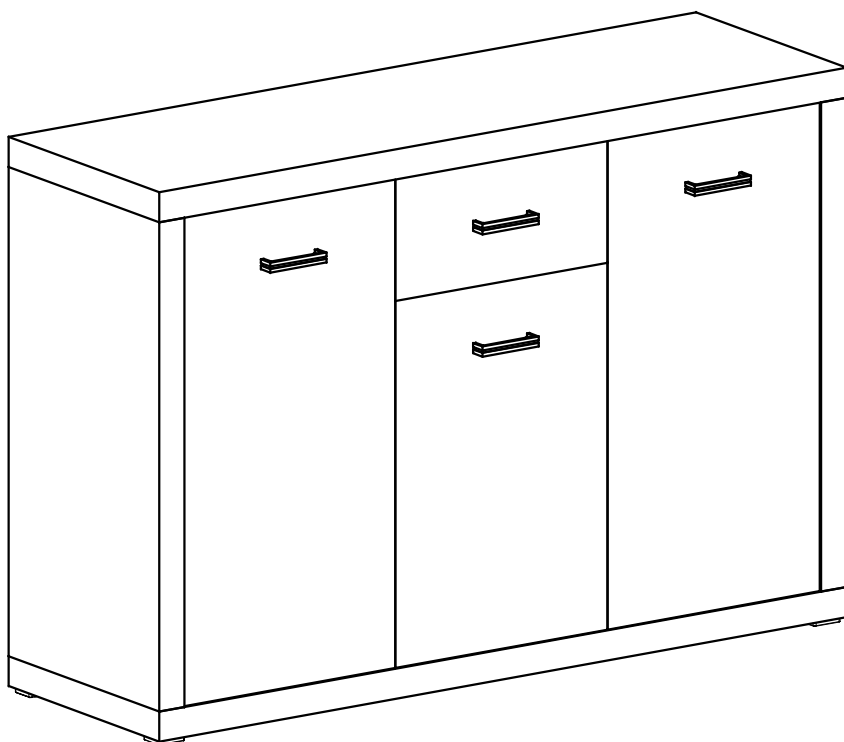

Nr	D[mm]	S[mm]	G[mm]	Ilość
1	1276	405	48	1
2	1276	405	48	1
3	780	405	48	1
4	780	388	16	1
5	780	388	16	1
6	780	405	48	1
7	393	320	16	2
8	417	320	16	1
9	1268	834	2,5	1
10	576	430	16	1
11	390	355	2,5	1
12	430	190	16	1
13	350	165	16	1
14	350	165	16	1
15	360	165	16	1
16	773	368	16	1
17	773	368	16	1

W przypadku reklamacji proszę podać numer pakowacza znajdujący się na kartonie.

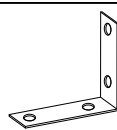

**Y - 2 St.**

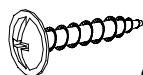

**Q - 4 St.**  
3,5x16 mm



**M - 14 St.**  
3x30 mm

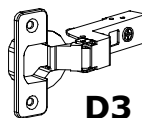

**D3 - 1 St.**

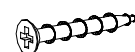

**P - 12 St.**  
3,9x25 mm

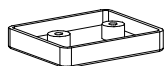

**W - 6 St.**

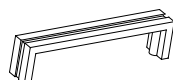

**U - 4 St.**



**G - 12 St.**  
3,5x16 mm



**D4 - 1 St.**

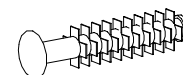

**F - 4 St.**



**R - 12 St.**



**N - 8 St.**  
5x25 mm

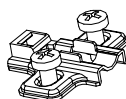

**C1 - 3 St.**

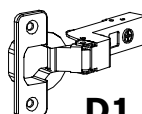

**D1 - 2 St.**



**L - 16 St.**

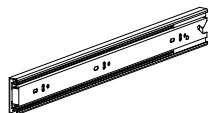

**T - 1 Kpl.**



**C2 - 3 St.**

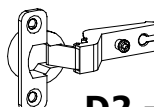

**D2 - 2 St.**



**S - 1 St.**



**E - 50 St.**



**B - 20 St.**

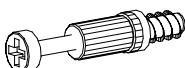

**K - 16 St.**

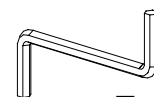

**Z - 1 St.**



**J - 8 St.**  
5x13 mm

I

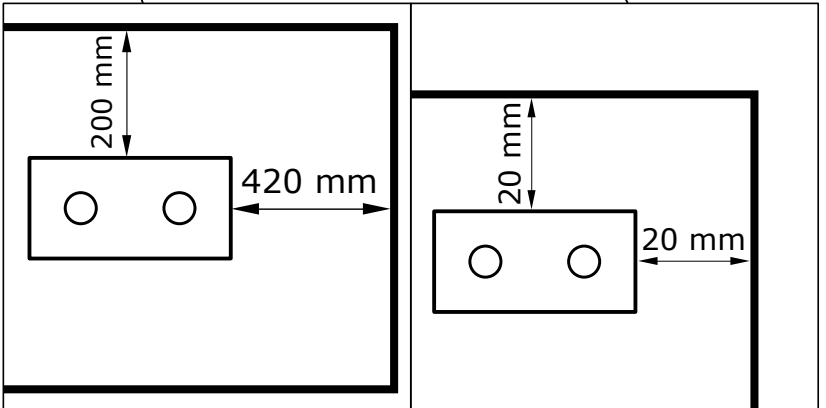
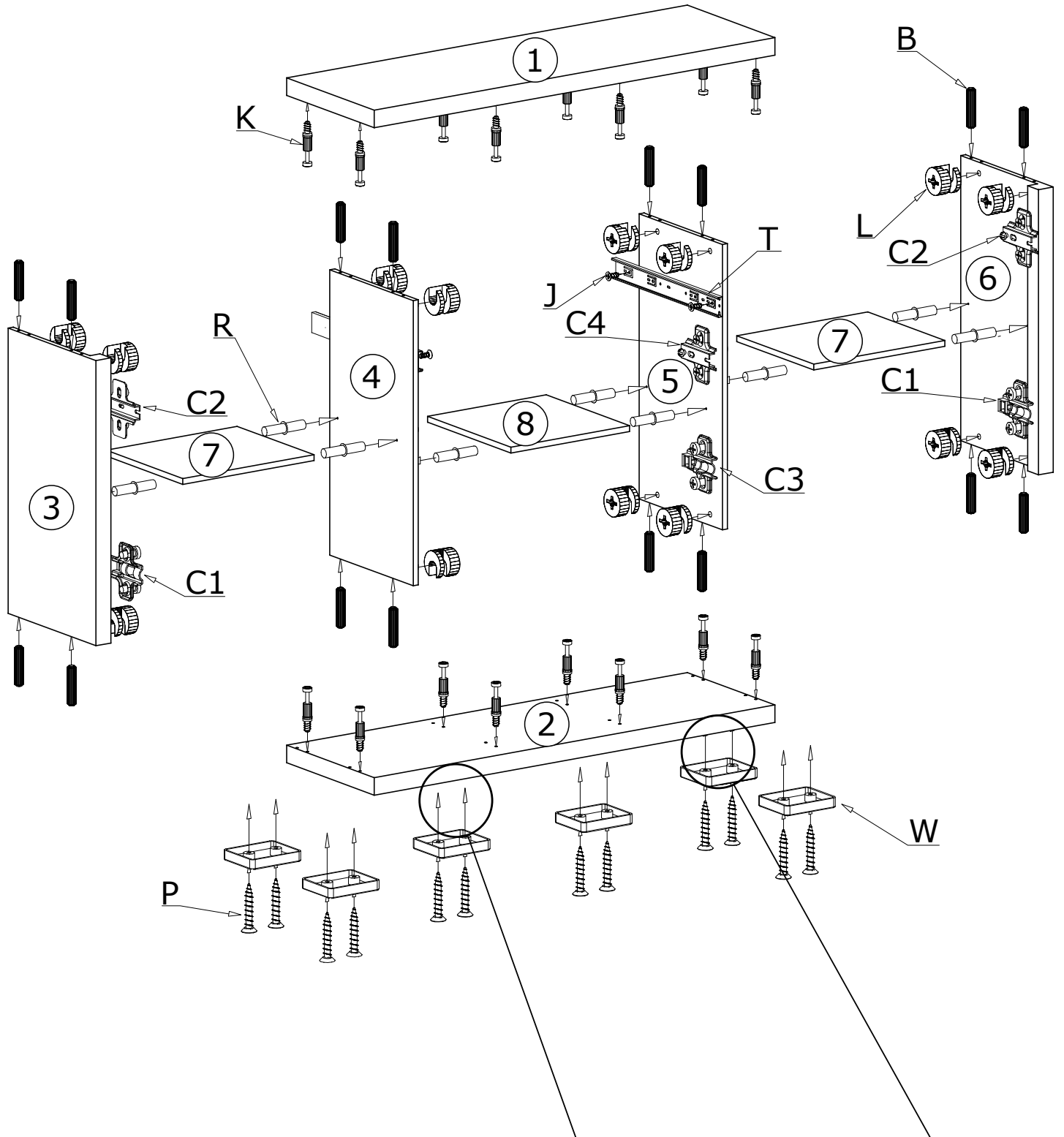

II

50X 

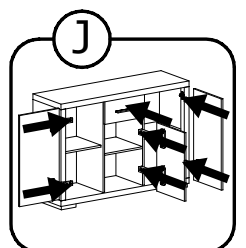
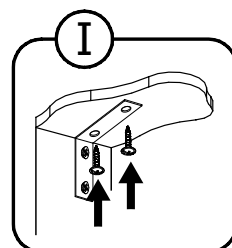
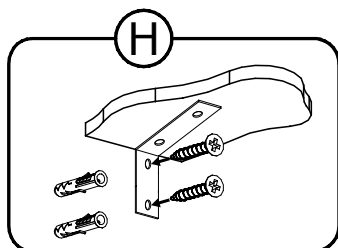
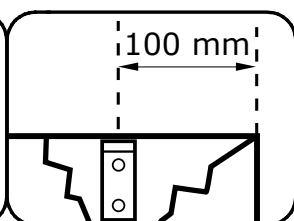
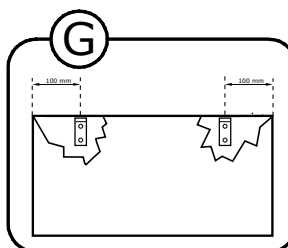
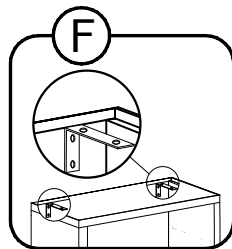
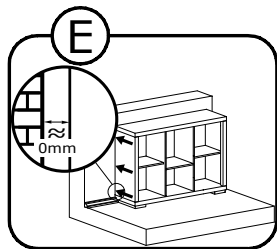
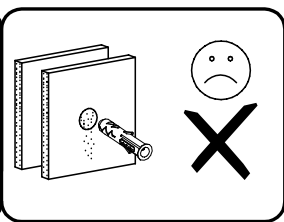
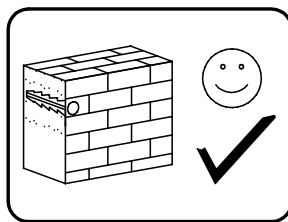
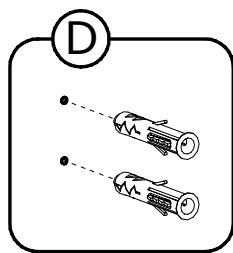
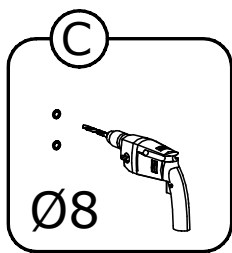
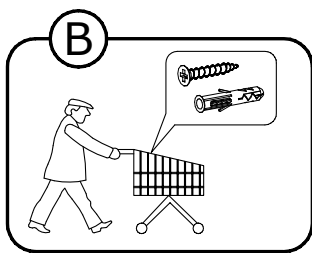
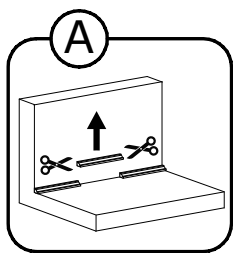
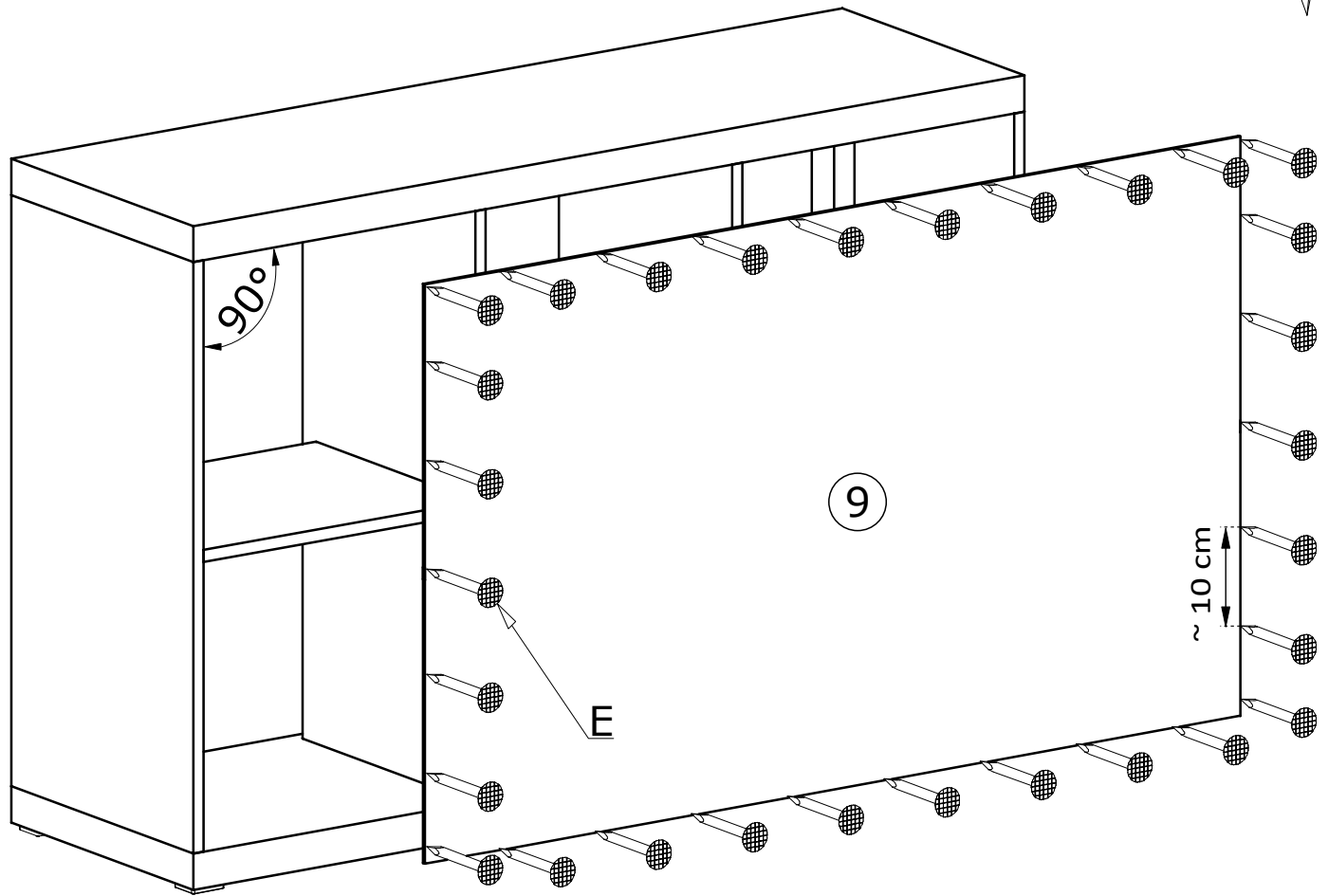

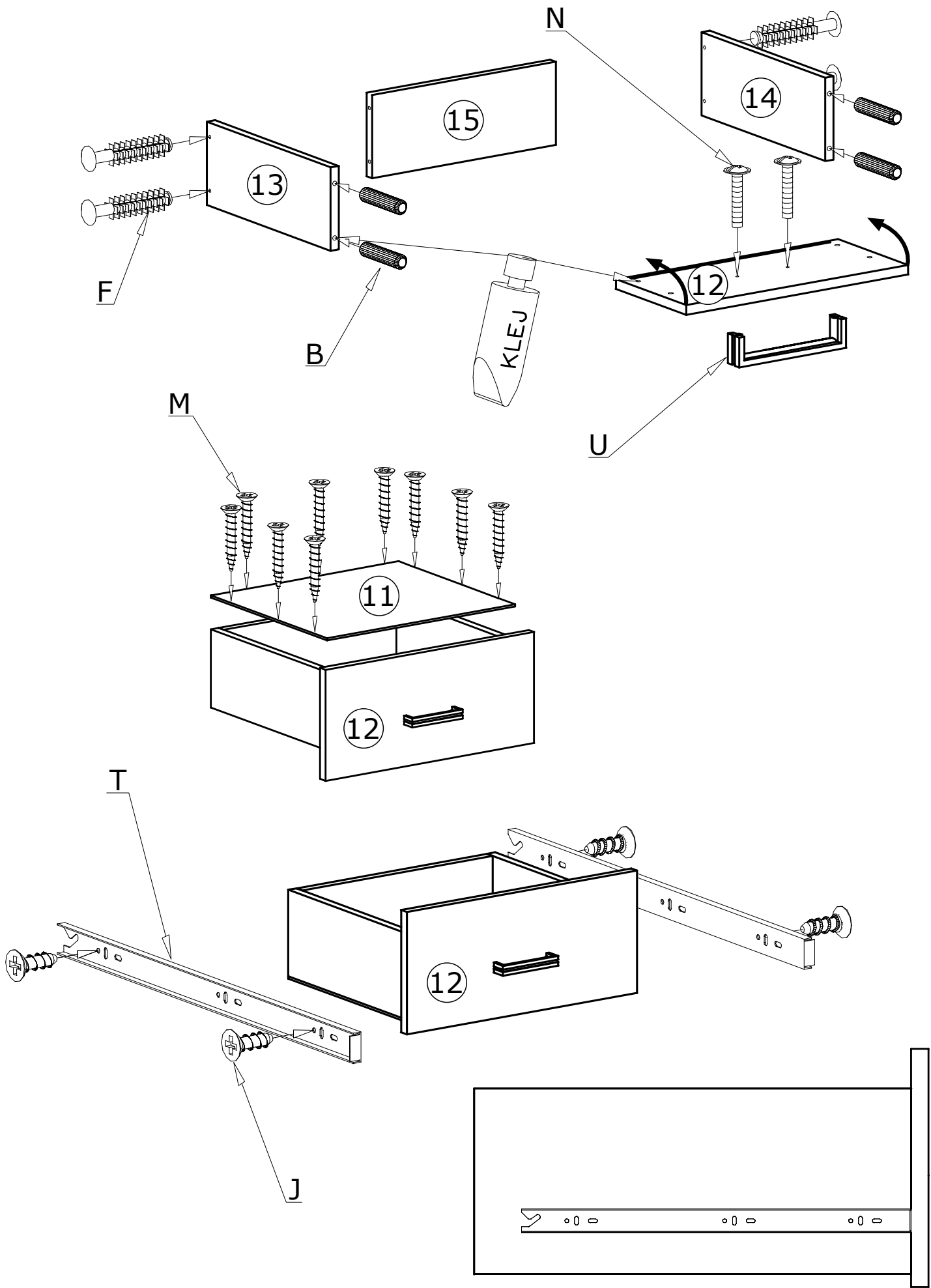

IV

D1, D2

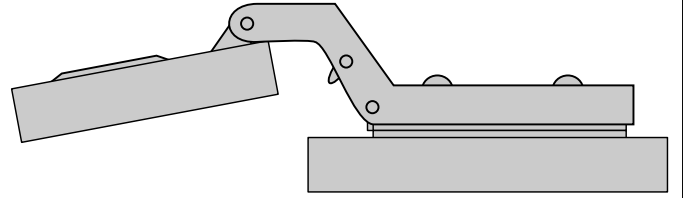

D3, D4

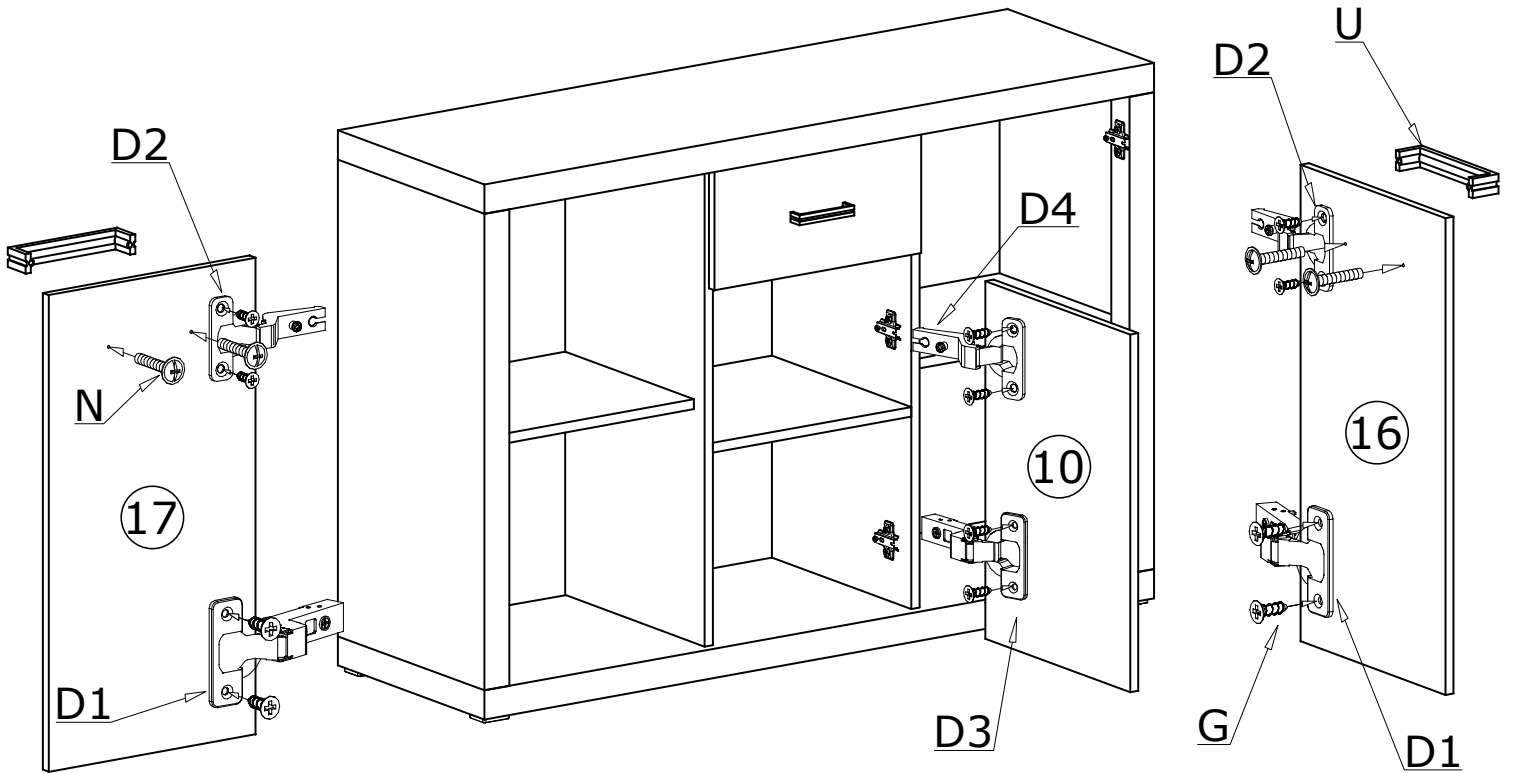
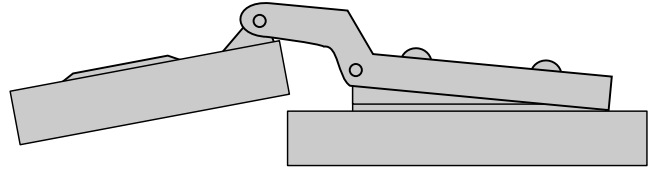

# MONTAŻ/DEMONTAŻ PROWADNIC

1



2

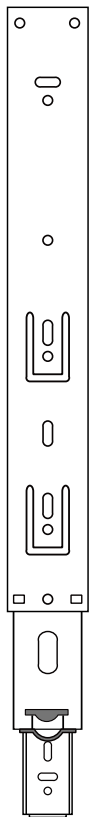

3

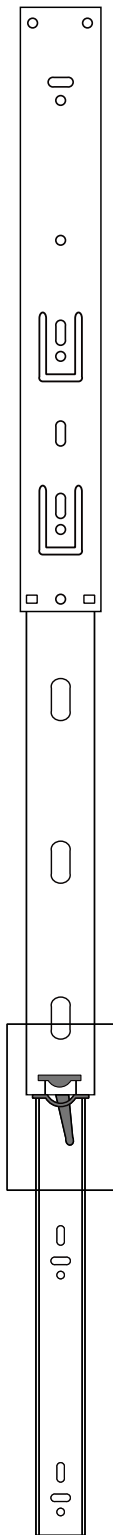

4

