

ORLANDO 5

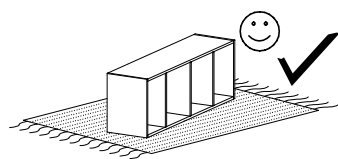

Narzędzia potrzebne do montażu

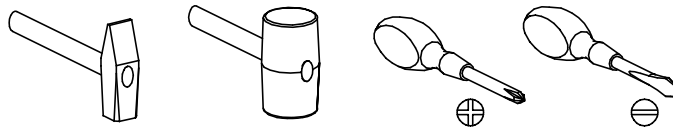

UWAGA !!!

MONTOWANIE USZKODZONYCH
ELEMENTÓW POWODUJE UTRATĘ
GWARANCJI

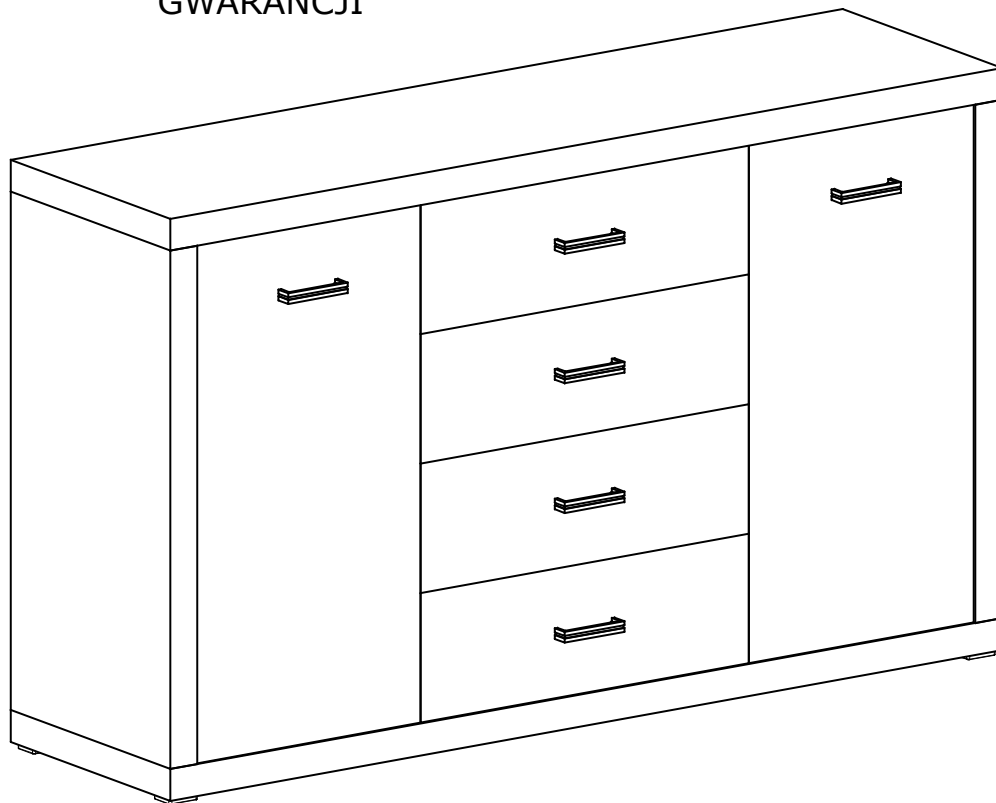

Nr	D[mm]	S[mm]	G[mm]	Ilość
1	1481	405	48	1
2	1481	405	48	1
3	780	405	48	1
4	780	388	16	1
5	780	388	16	1
6	780	405	48	1
7	398	320	16	2
8	1470	834	2,5	1
9	773	368	16	1
10	773	368	16	1
11	590	355	2,5	4
12	635	190	16	4
13	350	165	16	4
14	350	165	16	4
15	560	165	16	4

W przypadku reklamacji proszę podać numer pakowacza znajdujący się na kartonie.



M - 65 St.
3x30 mm

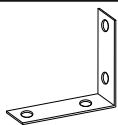

Y - 2 St.

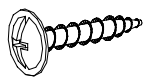

I - 4 St.
3,5x16 mm

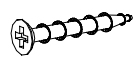

O - 12 St.
3,9x25 mm

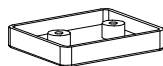

W - 6 St.

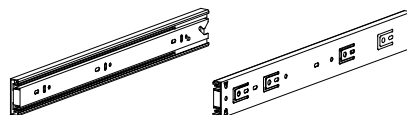

T - 4 Kpl.

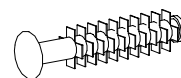

F - 16 St.

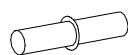

P - 8 St.

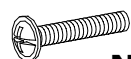

N - 12 St.
4x25 mm

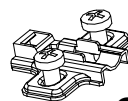

C1 - 2 St.

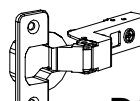

D1 - 2 St.



L - 16 St.



U - 6 St.



G - 8 St.
3,5x16 mm

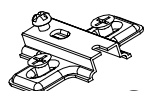

C2 - 2 St.

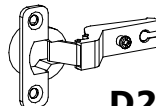

D2 - 2 St.



S - 1 St.



E - 50 St.



B - 32 St.

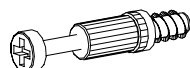

K - 16 St.



Z - 1 St.



J - 32 St.
5x13 mm

I

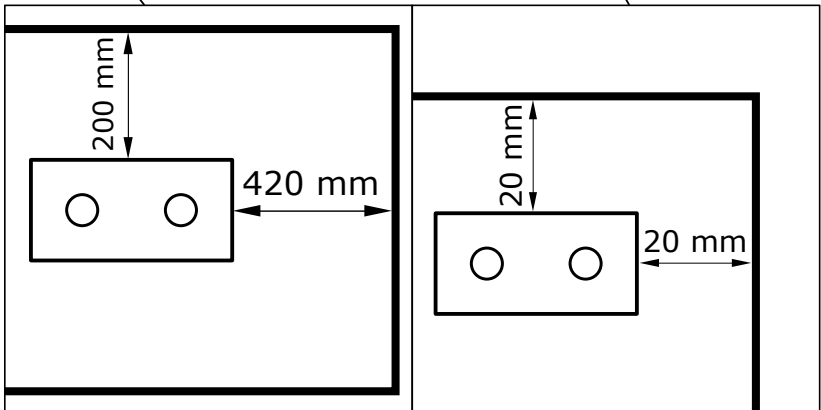
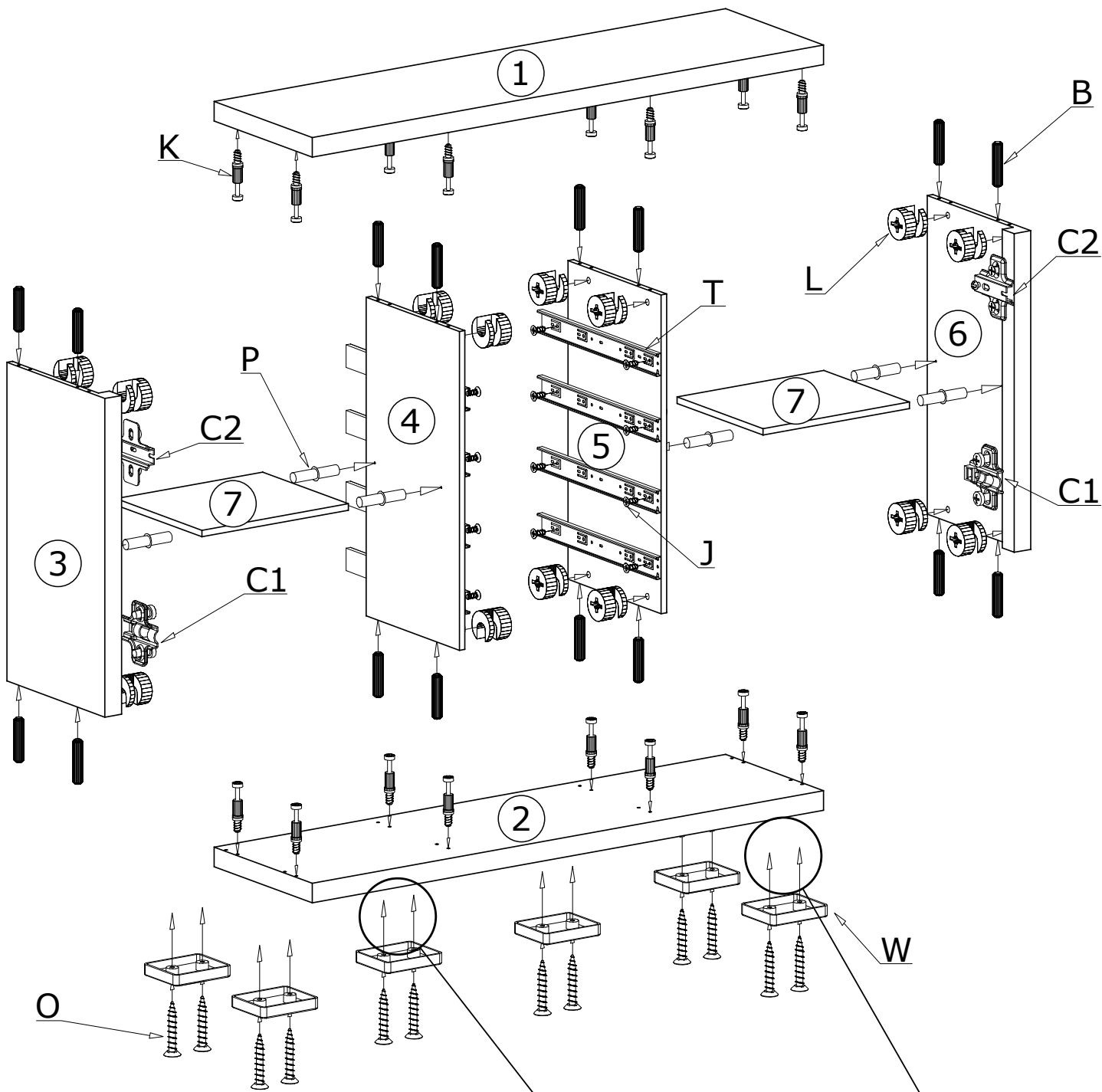

II

50X 

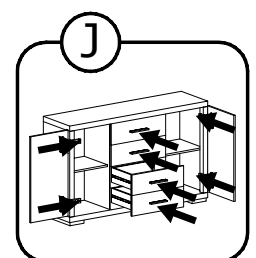
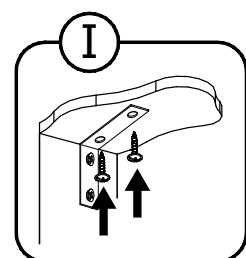
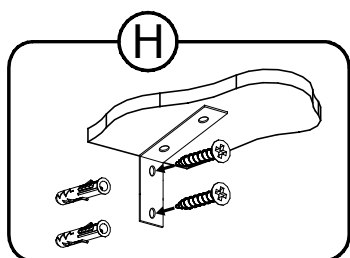
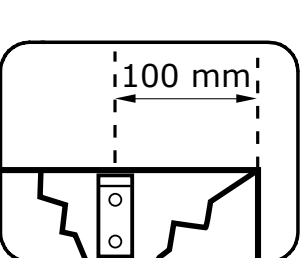
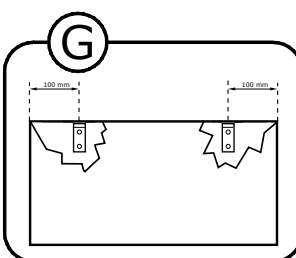
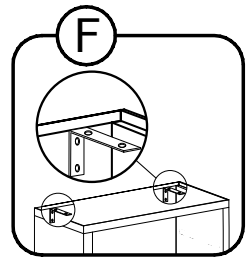
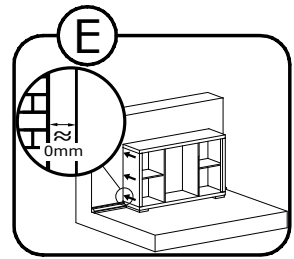
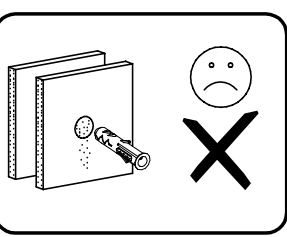
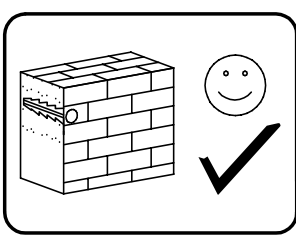
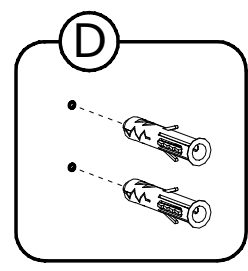
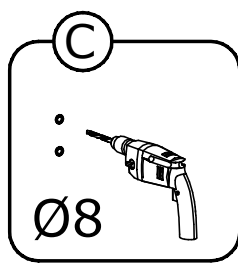
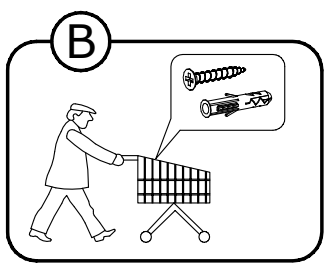
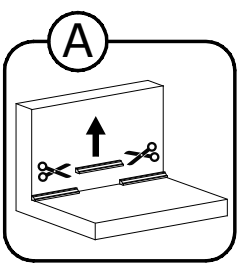
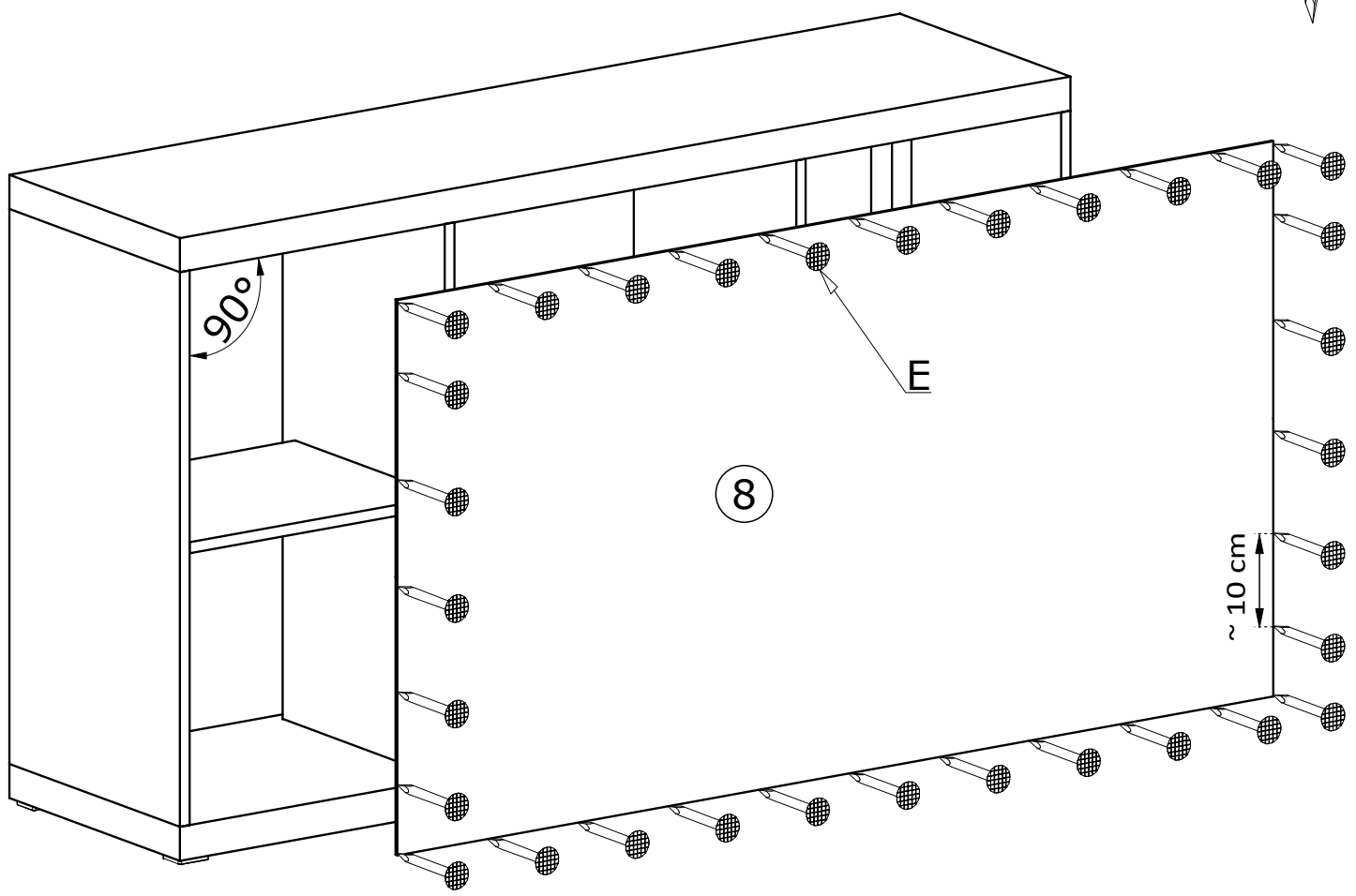

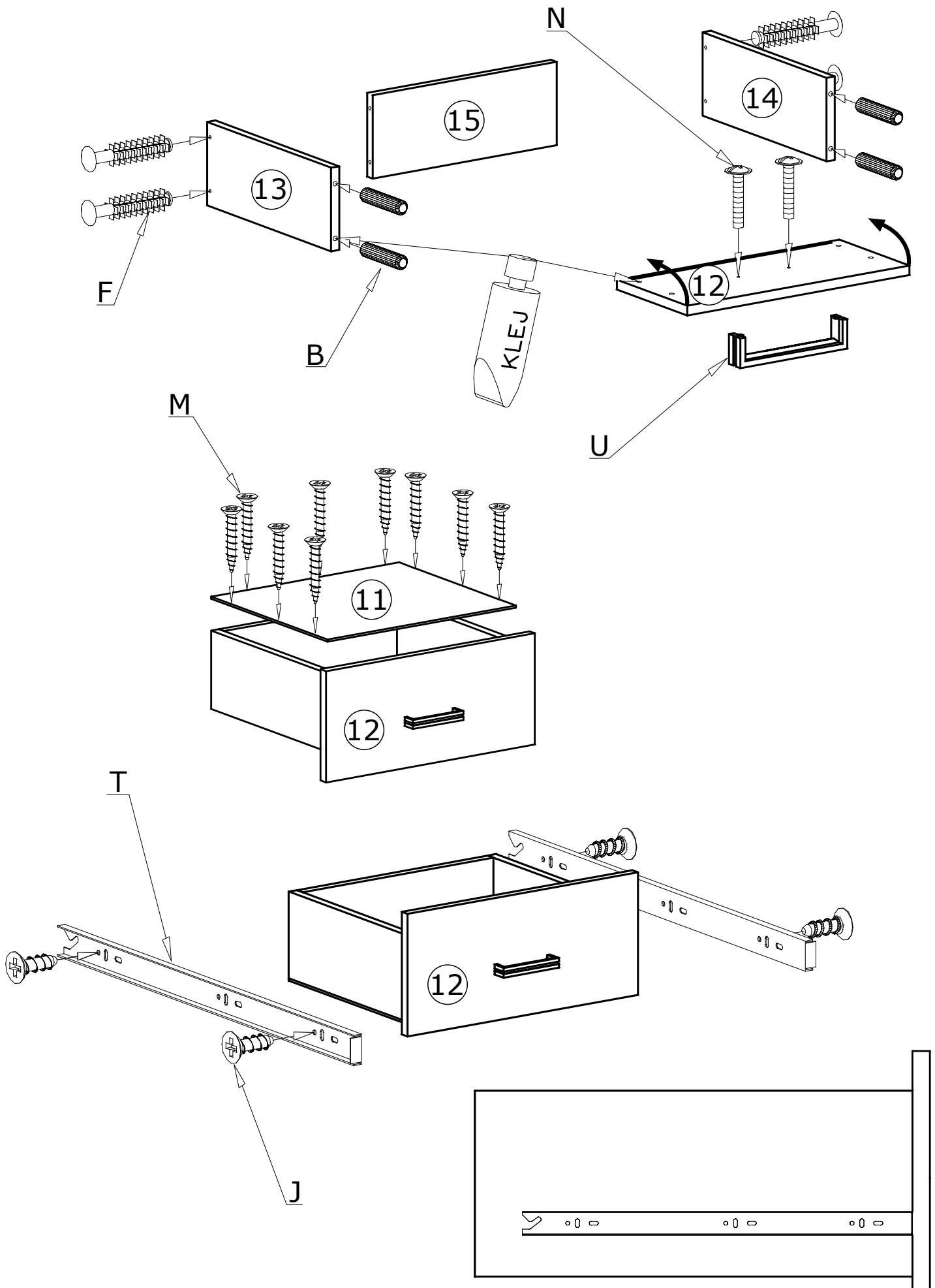

IV

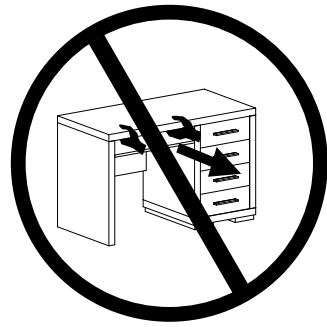
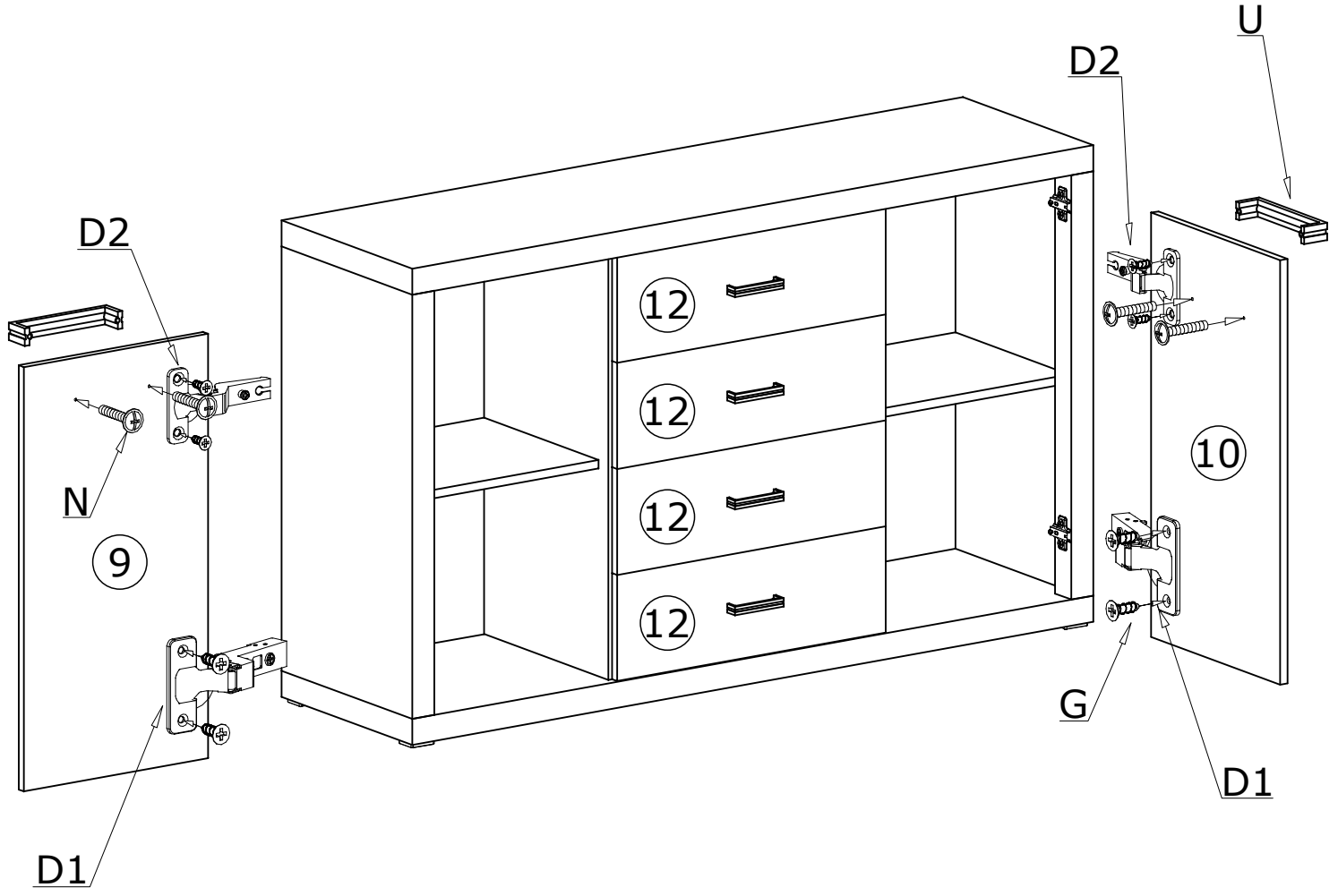

MONTAŻ/DEMONTAŻ PROWADNIC

1

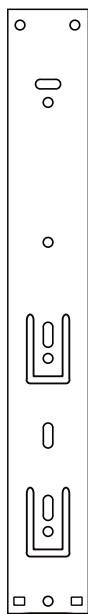

2

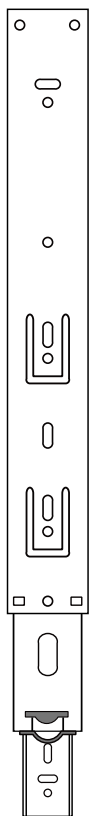

3

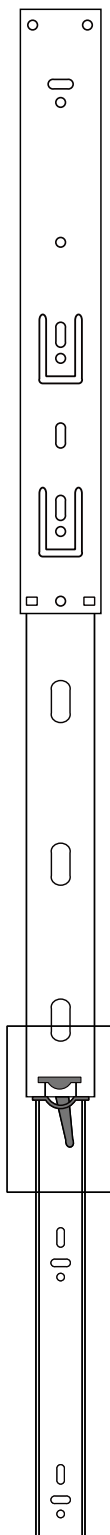

4

