

# ORLANDO 3



Narzędzia potrzebne do montażu



## UWAGA !!!

MONTOWANIE USZKODZONYCH  
ELEMENTÓW POWODUJE UTRATĘ  
GWARANCJI

Nr	D[mm]	S[mm]	G[mm]	Ilość
1	883	405	48	1
2	883	405	48	1
3	1790	405	48	1
4	1790	405	48	1
5	850	401	16	1
6	850	320	4	3
7	350	165	16	2
8	726	165	16	2
9	350	165	16	2
10	755	355	2,5	2
11	780	190	16	2
12	1815	872	2,5	1
13	1394	388	4	1
14	1394	388	4	1

W przypadku reklamacji proszę podać numer pakowacza znajdujący się na kartonie.

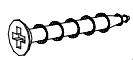

**O - 8 St.**  
3,9x25 mm

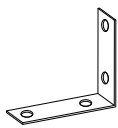

**Y - 2 St.**

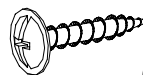

**Q - 4 St.**  
3,5x16 mm



**G - 4 St.**  
4x20 mm



**I - 4 St.**



**M - 60 St.**  
3x30 mm

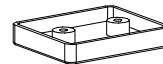

**W - 4 St.**

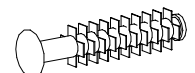

**F - 8 St.**



**P - 14 St.**

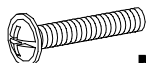

**N - 8 St.**  
4x30 mm



**U - 6 St.**

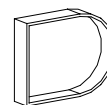

**R - 6 St.**

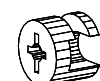

**L - 12 St.**

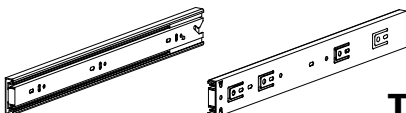

**T - 2 Kpl.**

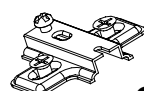

**C - 6 St.**

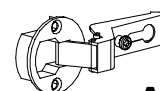

**A - 6 St.**



**S - 1 St.**



**E - 70 St.**



**B - 20 St.**

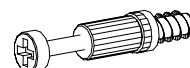

**K - 12 St.**

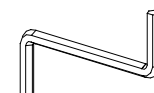

**Z - 1 St.**



**J - 16 St.**  
5x13 mm

I

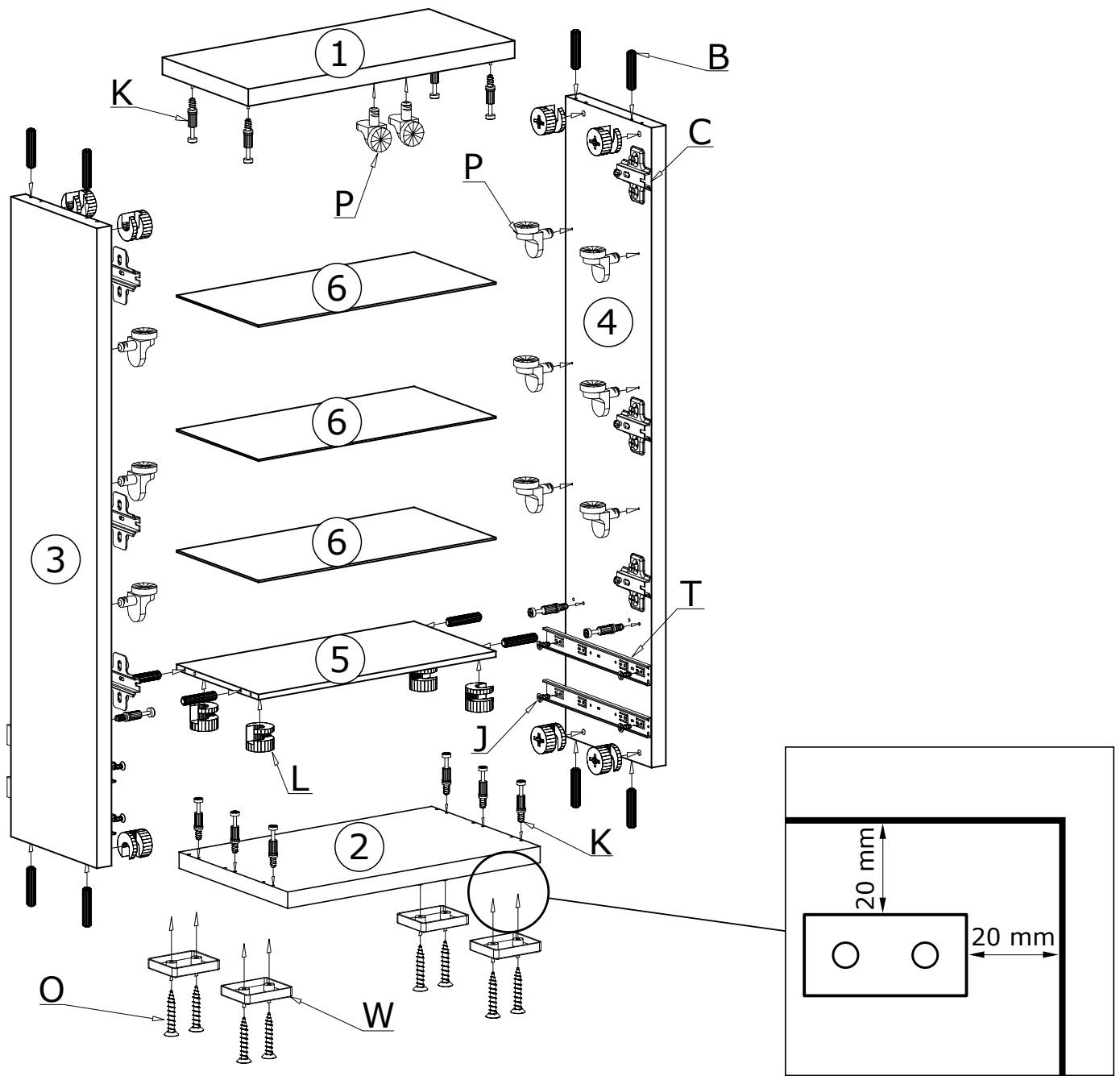

II

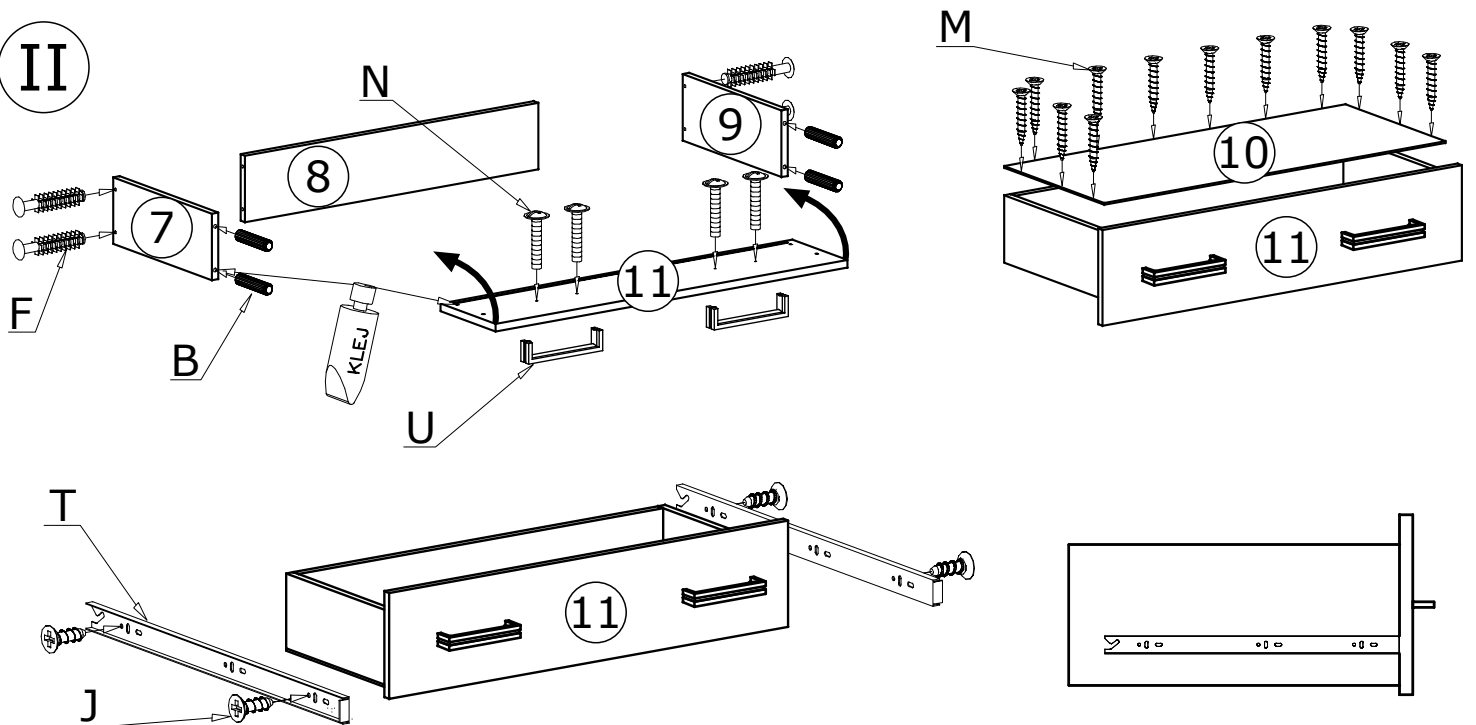

III

70X 

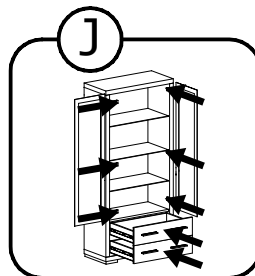
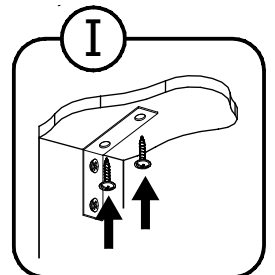
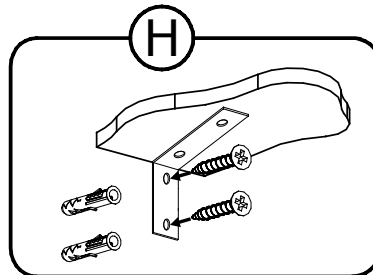
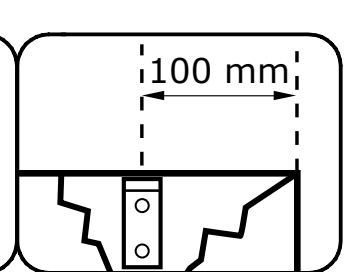
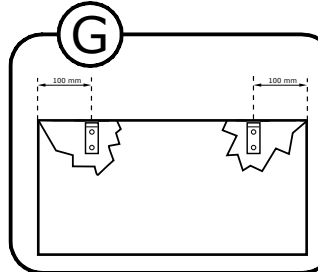
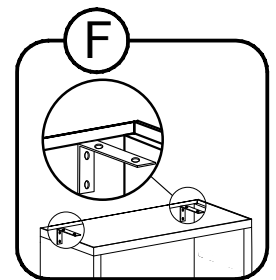
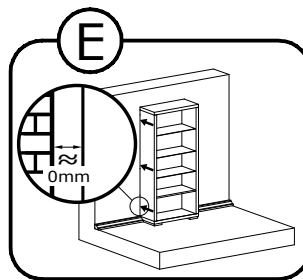
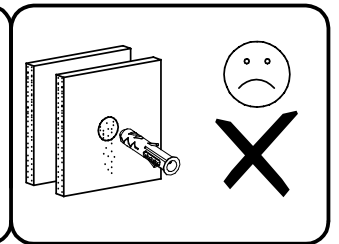
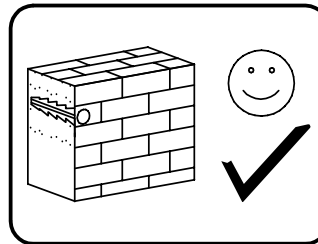
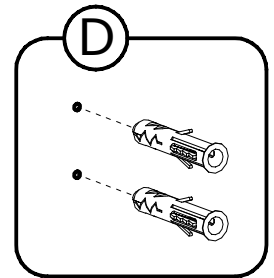
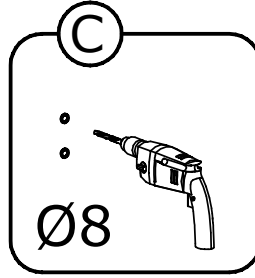
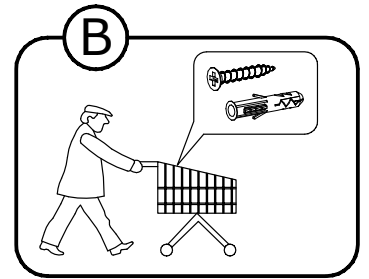
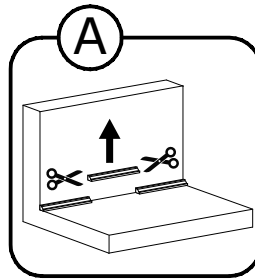
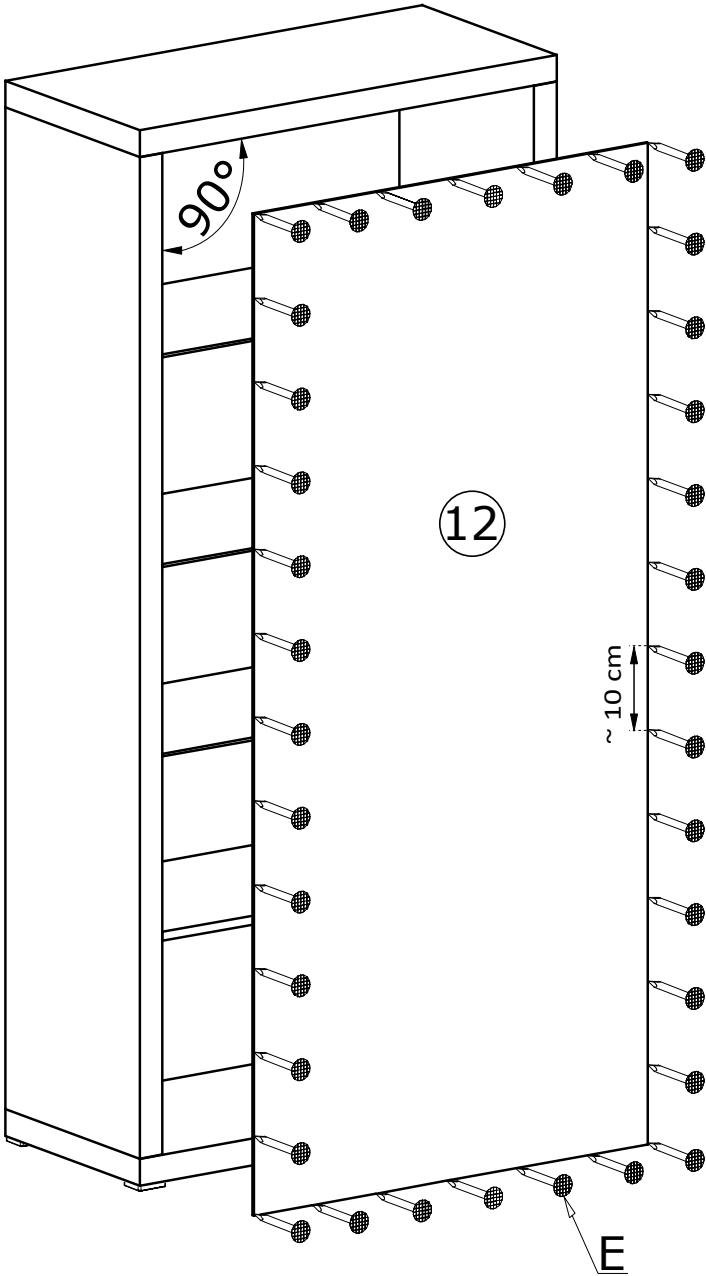

IV

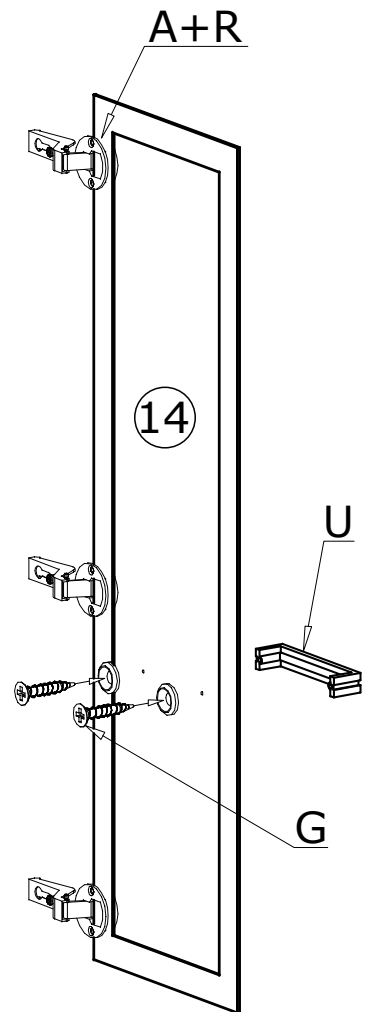
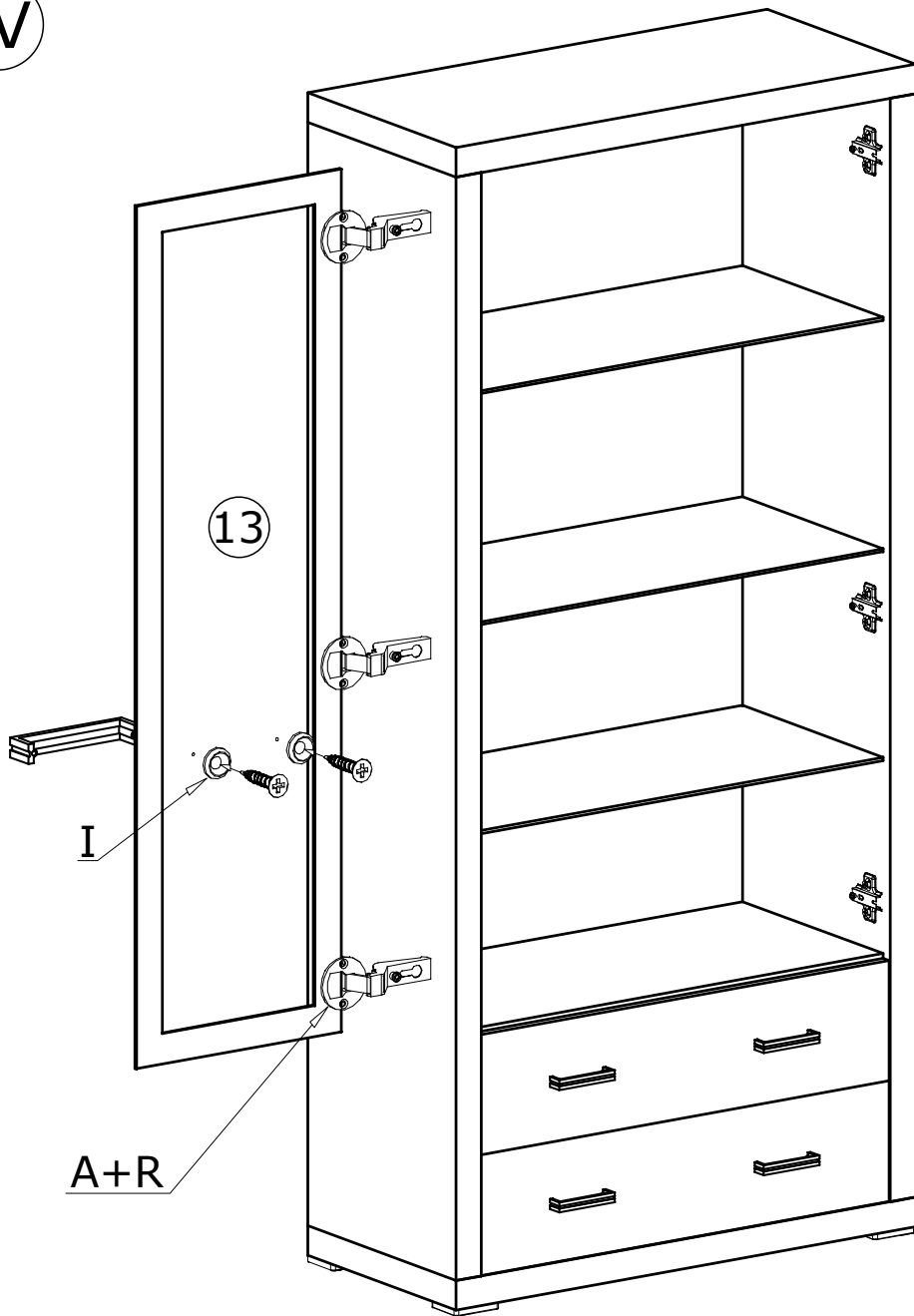

# MONTAŻ/DEMONTAŻ PROWADNIC

1

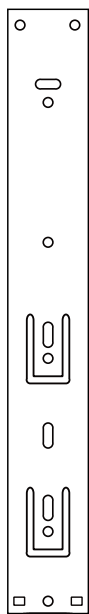

2

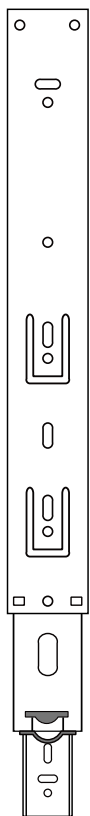

3

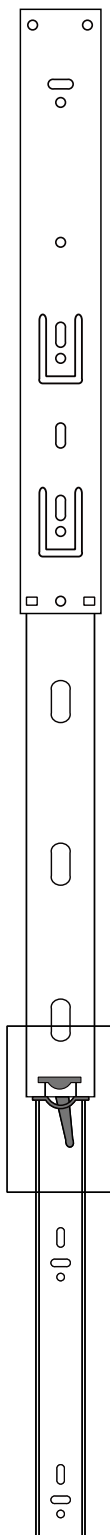

4

