

ORLANDO 2

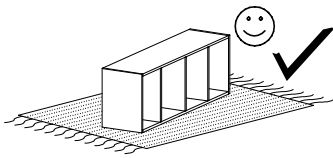

Narzędzia potrzebne do montażu

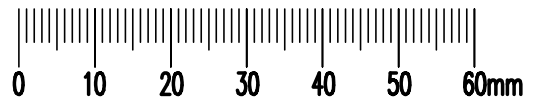
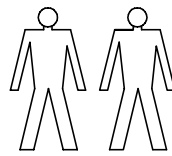
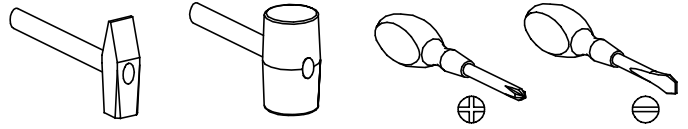

UWAGA !!!

MONTOWANIE USZKODZONYCH
ELEMENTÓW POWODUJE UTRATĘ
GWARANCJI

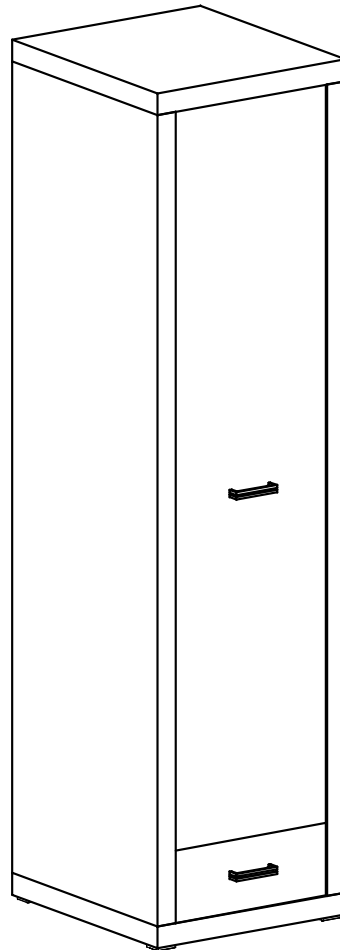

Nr	D[mm]	S[mm]	G[mm]	Ilość
1	540	493	48	1
2	540	493	48	1
3	522	458	16	1
4	1790	540	48	1
5	1790	540	48	1
6	1590	388	16	1
7	1815	482	2,5	1
8	388	190	16	1
9	500	165	16	1
10	337	165	16	1
11	500	165	16	1
12	505	368	2,5	1

W przypadku reklamacji proszę podać numer pakowacza znajdujący się na kartonie.



X1 - 2 St.

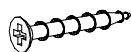

Q - 8 St.
3,9x25 mm

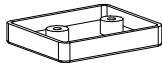

W - 4 St.

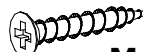

M - 14 St.
3x30 mm

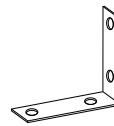

Y - 2 St.



I - 4 St.
3,5x16 mm

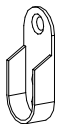

A - 2 St.



O - 1 St.

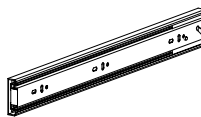

C1 - 1 St.

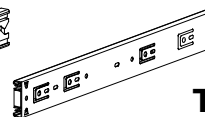

T - 1 Kpl.

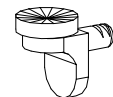

P - 1 St.

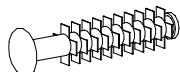

F - 4 St.

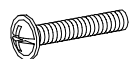

N - 4 St.
4x25 mm

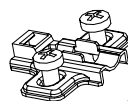

C2 - 2 St.

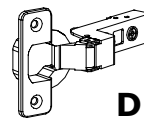

D1 - 1 St.



L - 16 St.



U - 2 St.



G - 10 St.
3,5x16 mm

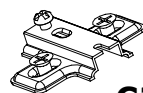

K - 16 St.

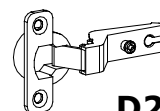

D2 - 2 St.



S - 1 St.



E - 50 St.



B - 20 St.

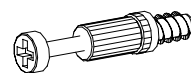

Z - 1 St.

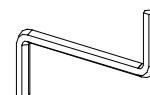

J - 8 St.
5x13 mm



I

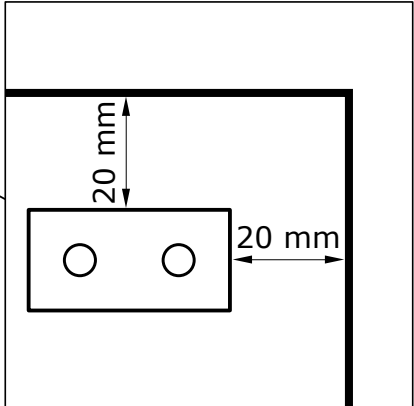
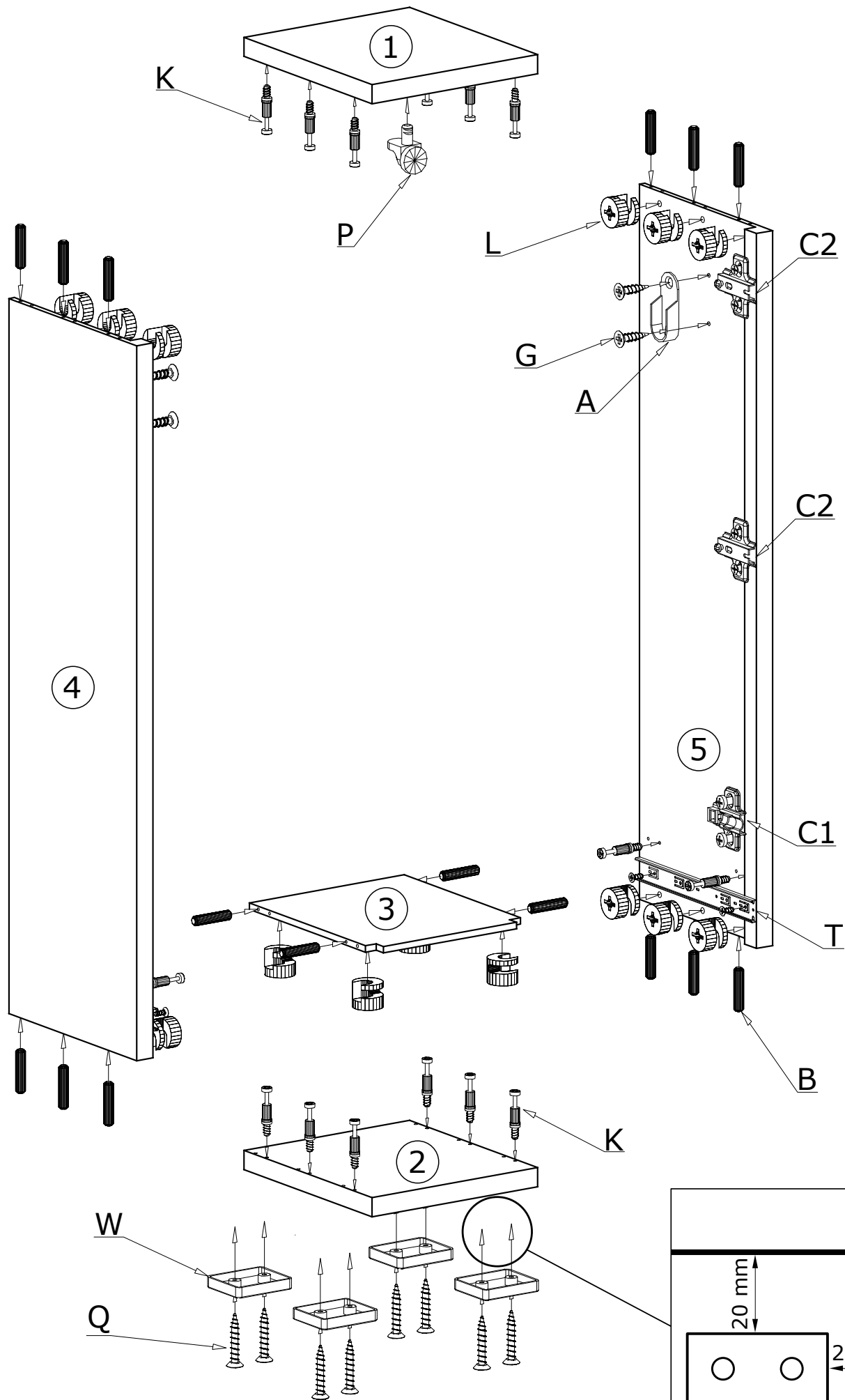

II

50X 

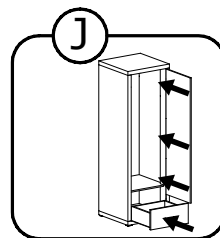
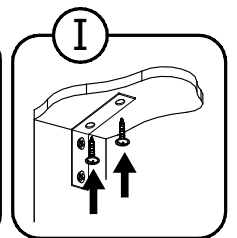
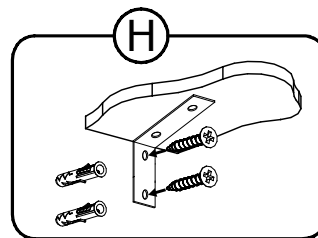
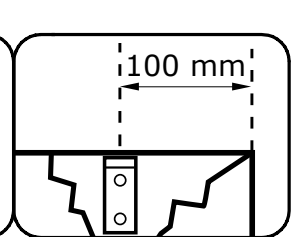
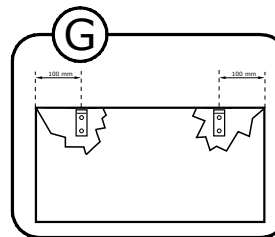
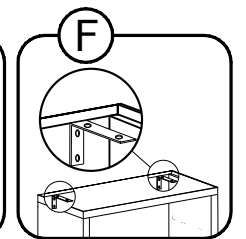
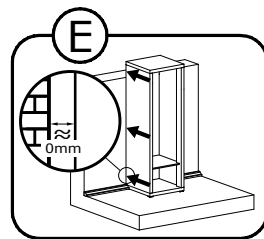
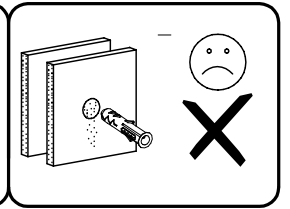
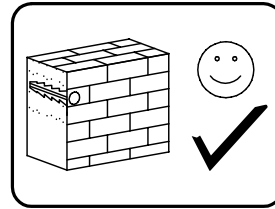
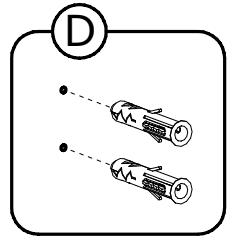
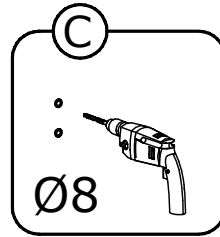
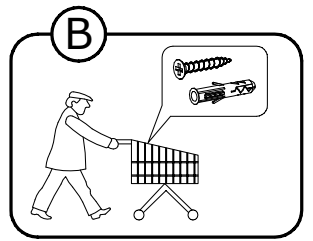
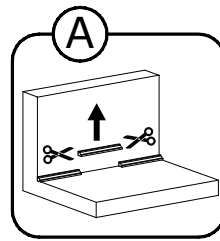
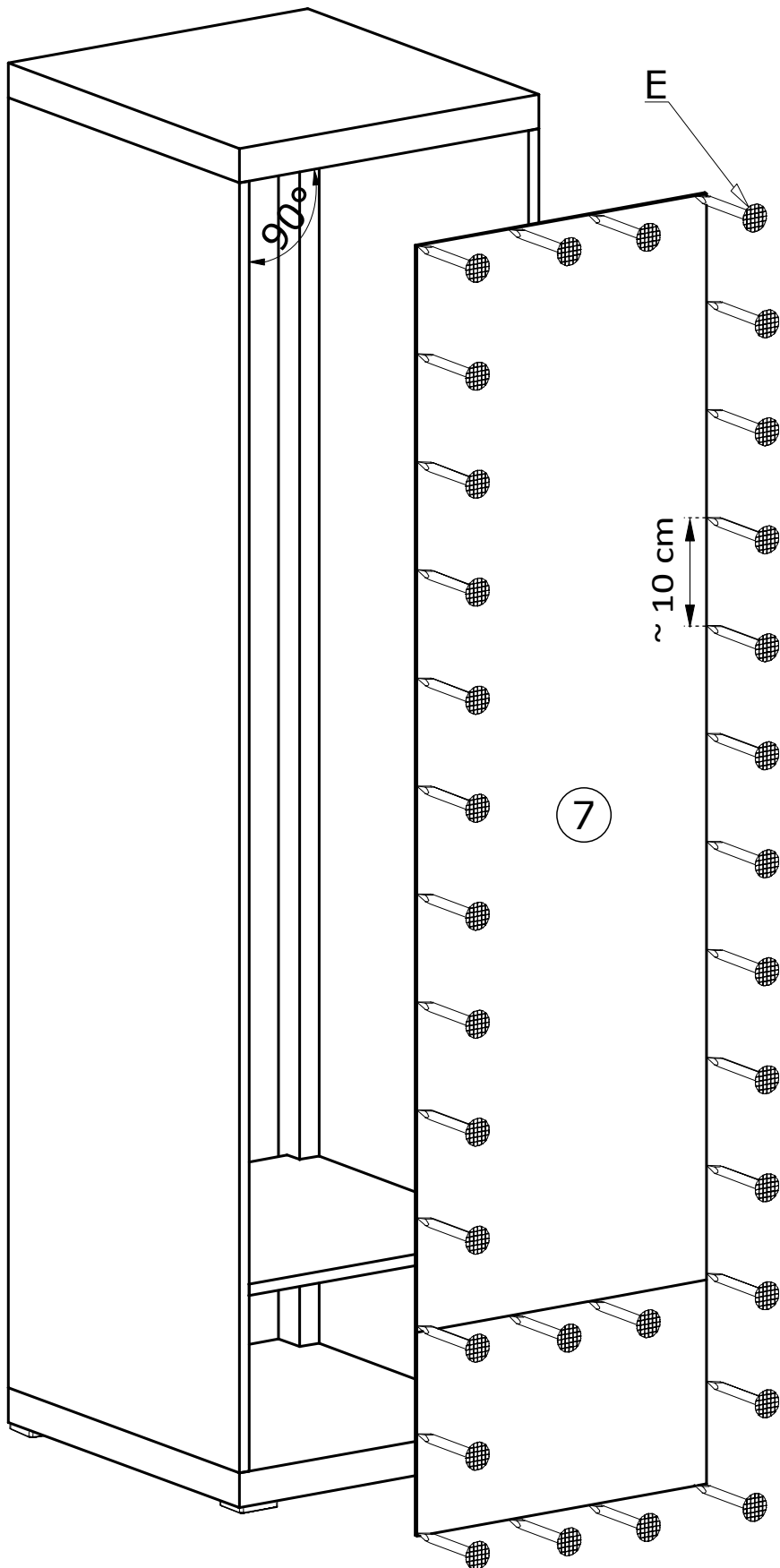

III

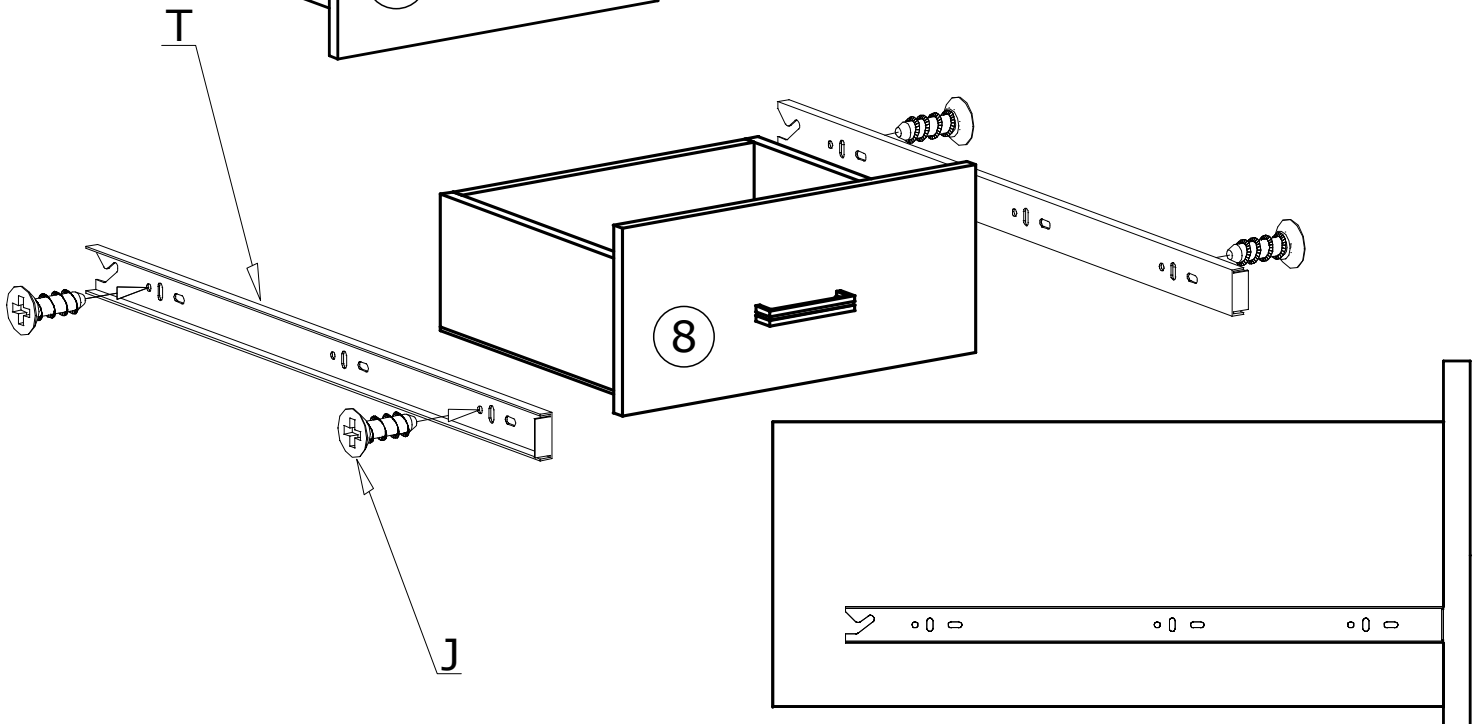
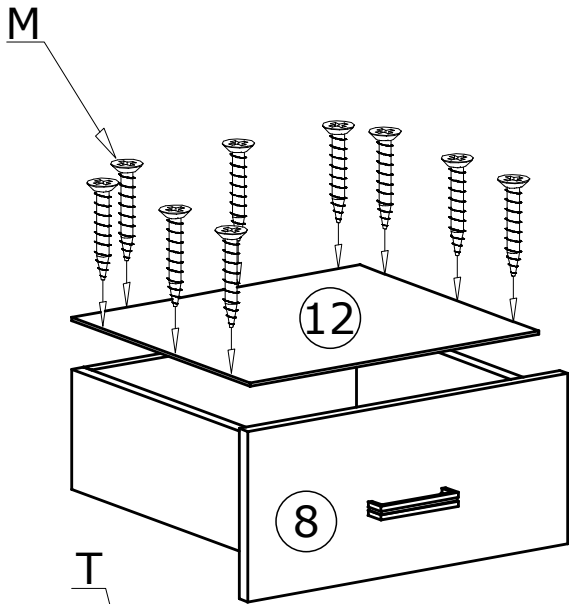
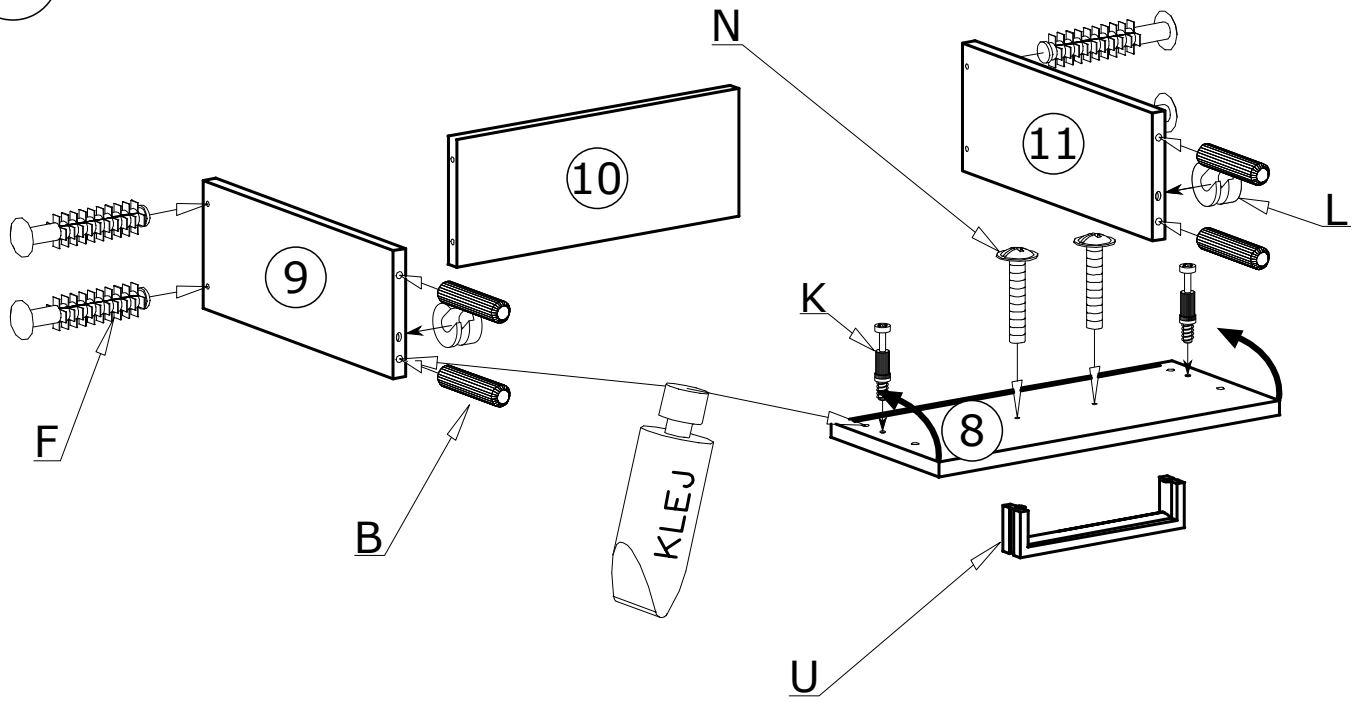

IV

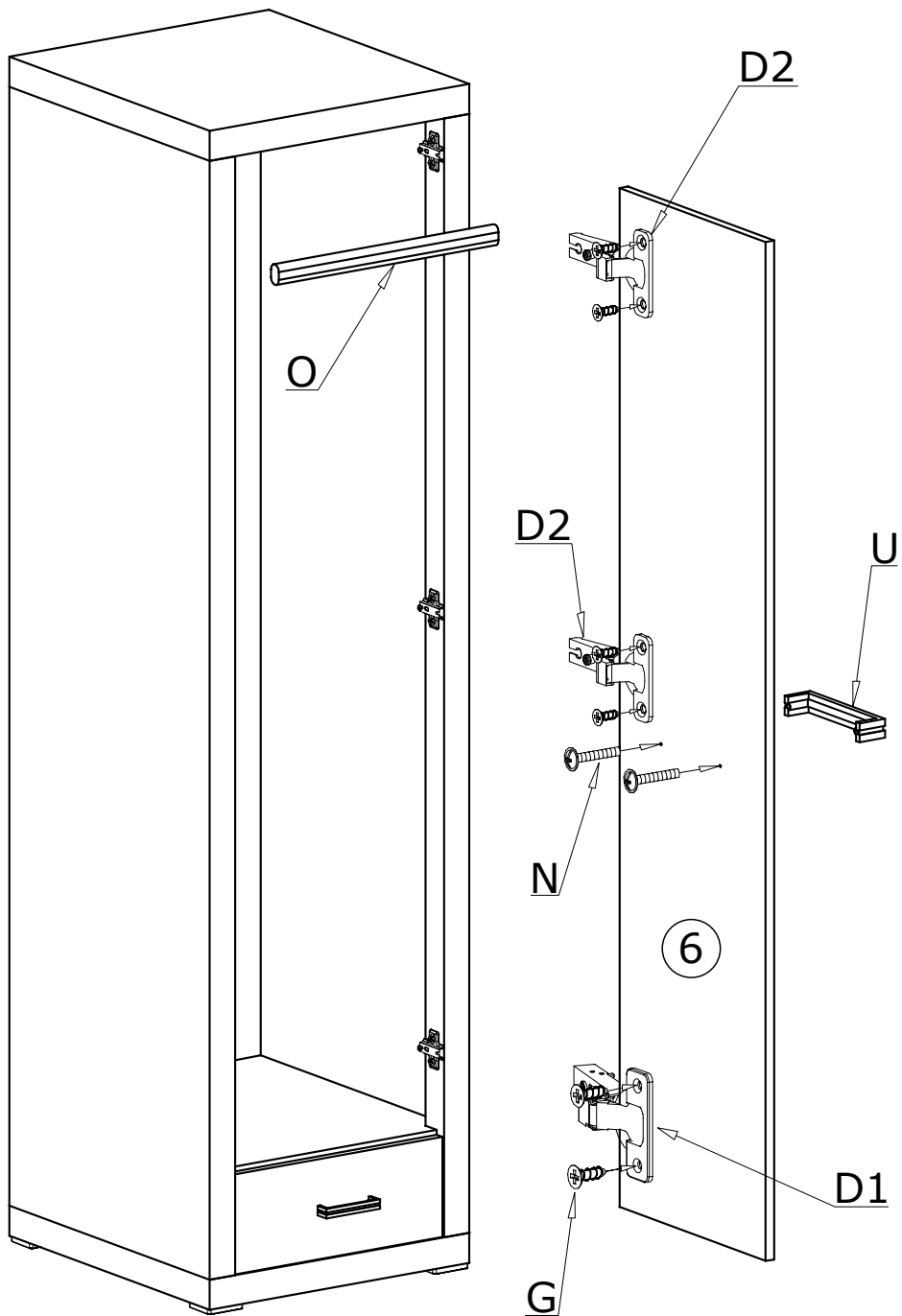

MONTAŻ/DEMONTAŻ PROWADNIC

1

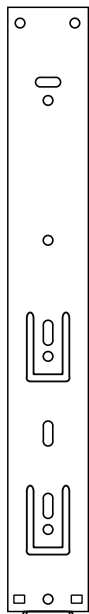

2

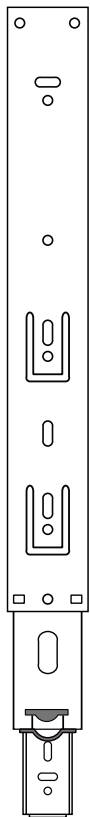

3

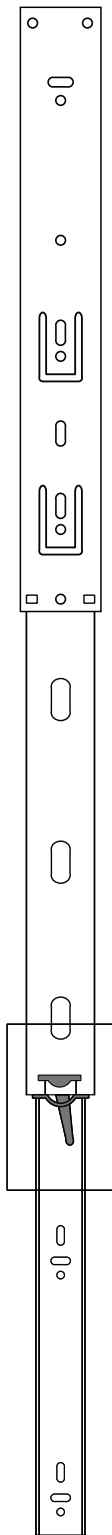

4

