

system PARIS

P-3

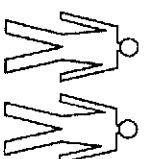

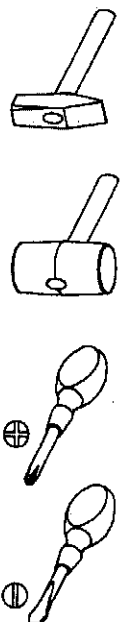





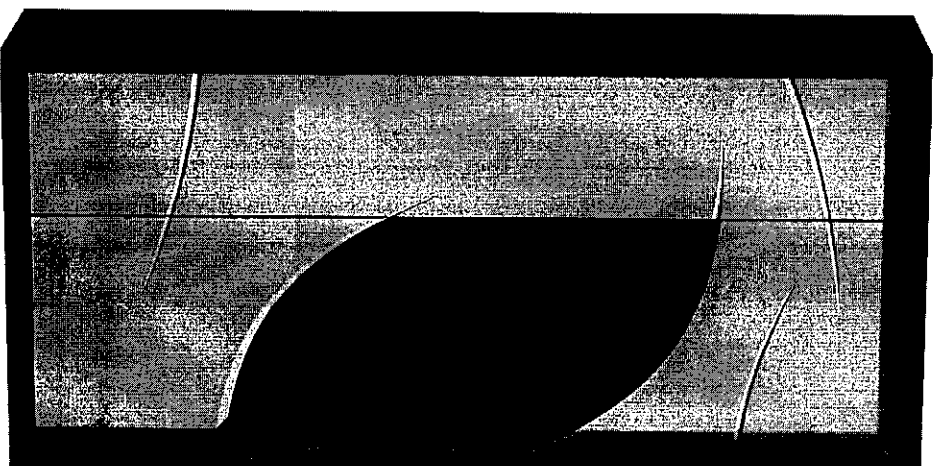

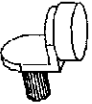

Narzędzia potrzebne do montażu

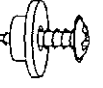
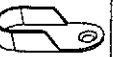

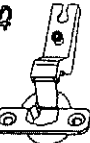
UWAGA!
MONTOWANIE USZKODZONYCH
ELEMENTÓW POWODUJE UTRATĘ
GWARANCJI!



W przypadku reklamacji proszę o podanie numeru pakowacza znajdującego się na kartonie

 P - 10 St.	 M - 8 St. 3 x 25 mm	 G - 20 St. 3,5 x 16 mm	 G - 8 St. 3,5 x 16 mm	
 A - 2 St.	 S - 2 St.	 C - 7 St.	 D - 7 St.	 L - 16 St.
 E - 80 St.	 B - 16 St.	 K - 16 St.	 Z - 1 St.	 D - 4 St.

1

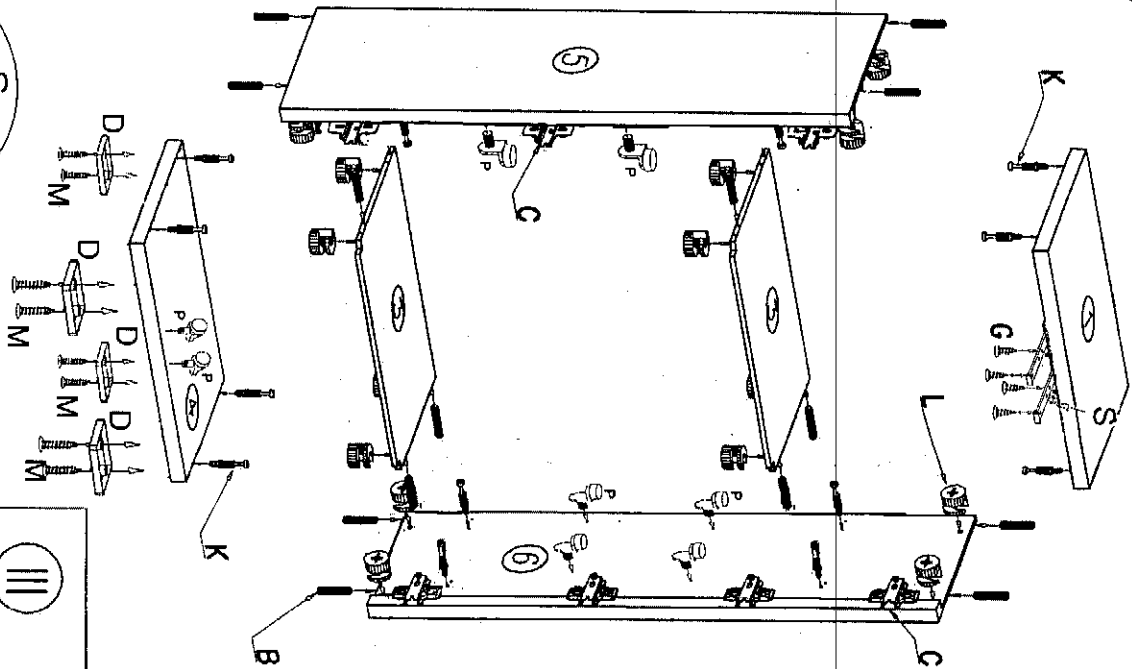

II

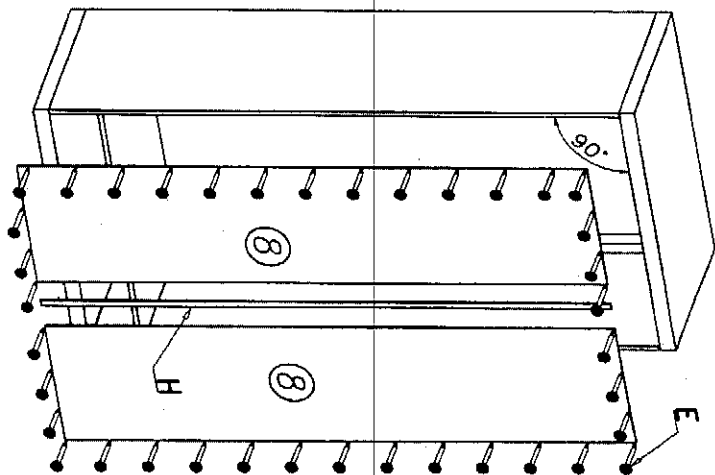

III

