

system VEGAS

V-18

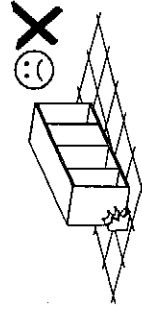

Narzędzia potrzebne do montażu

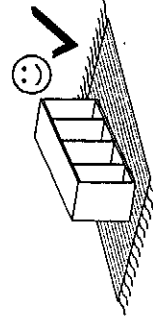
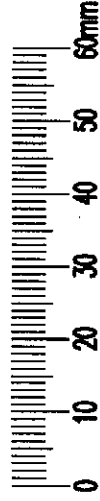
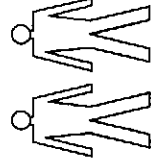
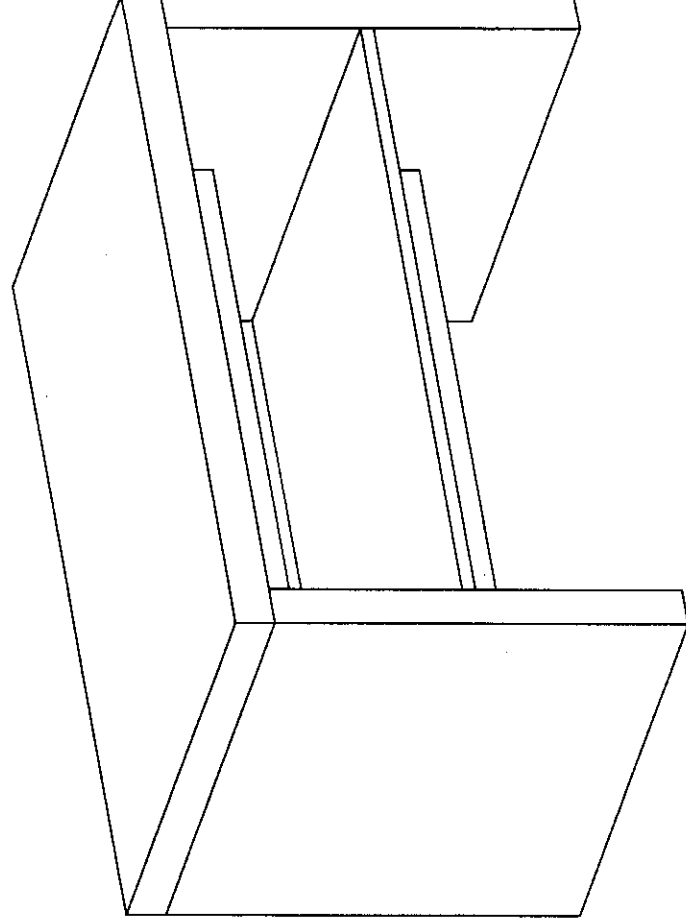
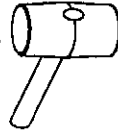

W przypadku reklamacji proszę o podanie numeru pakowacza znajdującego się na kartonie



B - 10 St.



K - 18 St.



Z - 1 St.

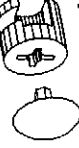

L - 18 St.

