

system TADEUSZ

T-2

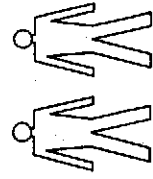

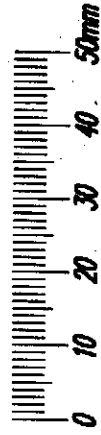



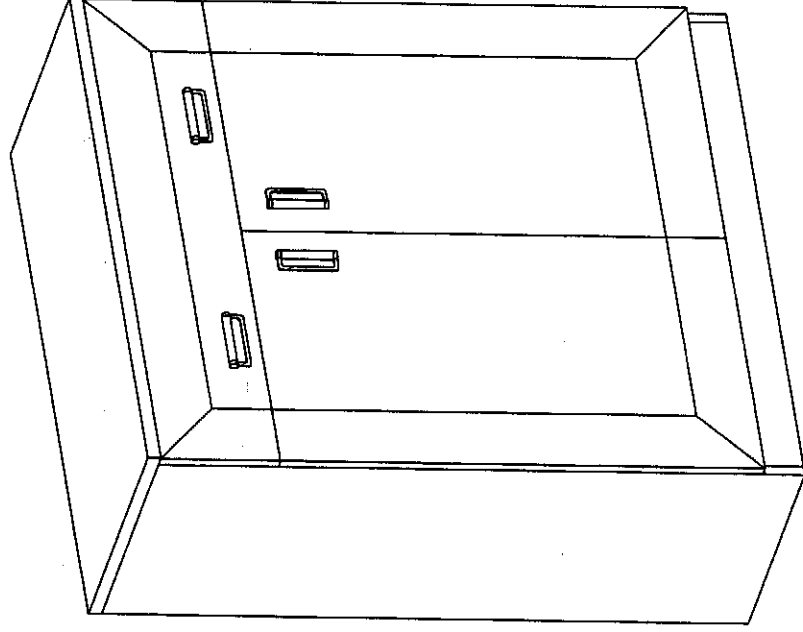
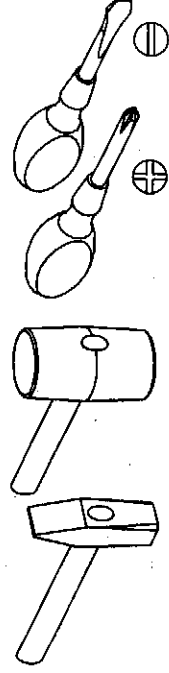



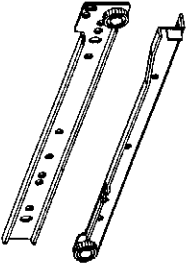

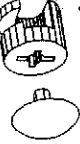

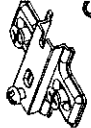
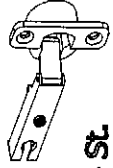

INSTRUKCJA MONTAŻU

Narzędzia potrzebne do montażu



W przypadku reklamacji proszę o podanie numeru pakowacza znajdującego się na kartonie

| | | | |
|--|---|---|--|
|  T - 1 Kpl. |  M - 4 St. 4 x 25 mm |  H - 1 St. |  L - 4 St. |
|  F - 4 St. |  N - 8 St. M4 x 25 mm |  U - 4 St. |  G - 8 St. 3,5 x 16 mm |
|  R - 9 St. |  E - 50 St. |  C - 4 St. |  D - 4 St. |
|  B - 20 St. |  K - 4 St. |  Z - 1 St. |  S - 1 St. |
| | | |  J - 4 St. 5 x 13 mm |

I

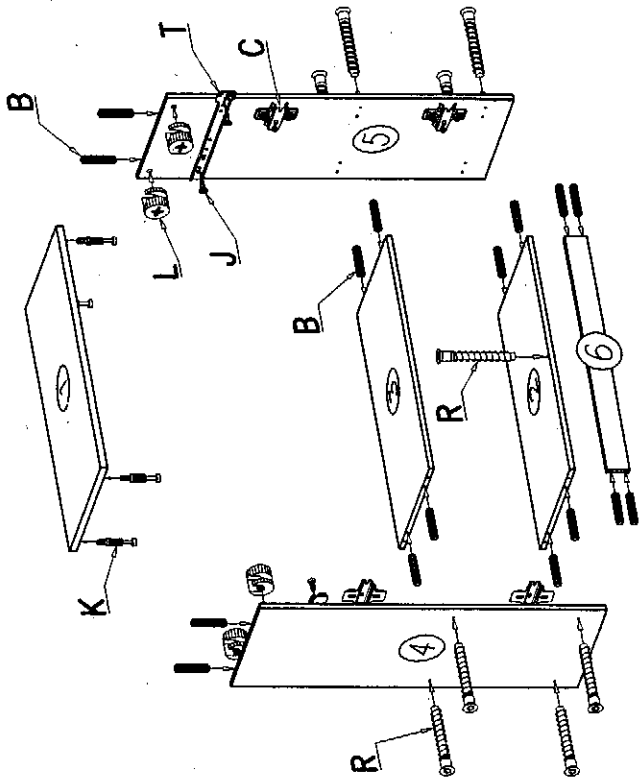

III

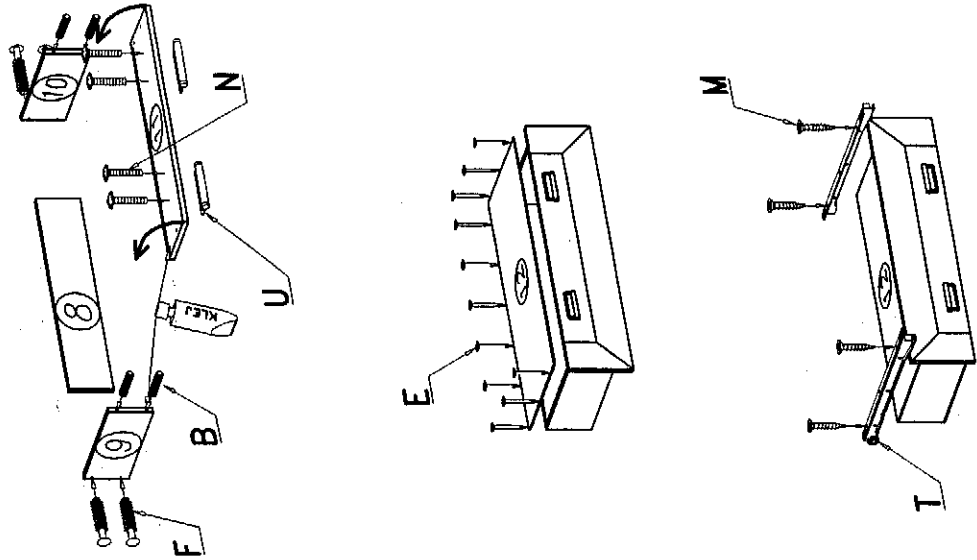

II

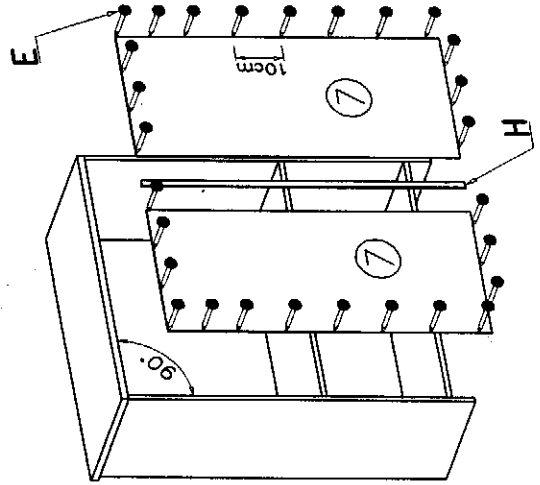

IV

