

system **DALLAS**

D-14

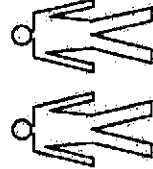
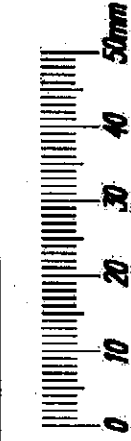

INSTRUKCJA MONTAŻU

Narzędzia potrzebne do montażu

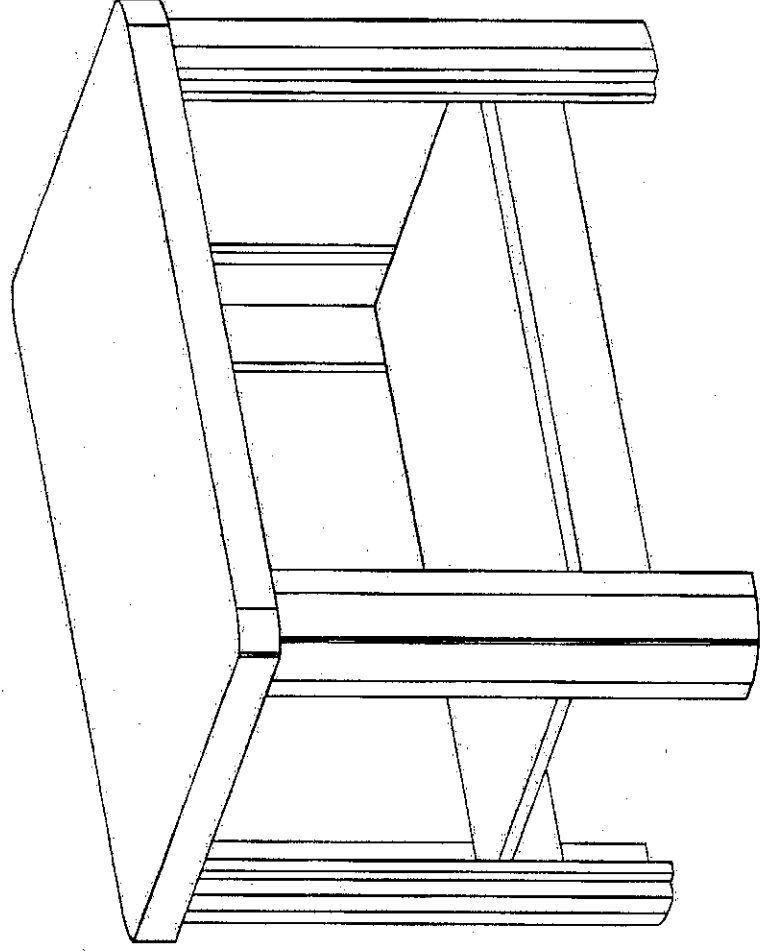
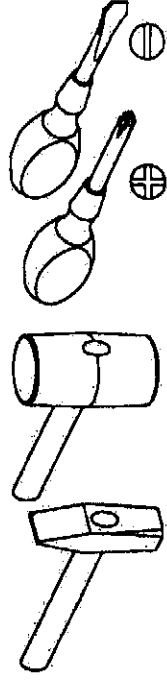

W przypadku reklamacji proszę o podanie numeru pakowacza znajdującego się na kartonie



A - 22 St.



B - 10 St.

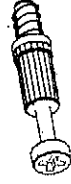

K - 22 St.



Z - 1 St.



S - 1 St.

①

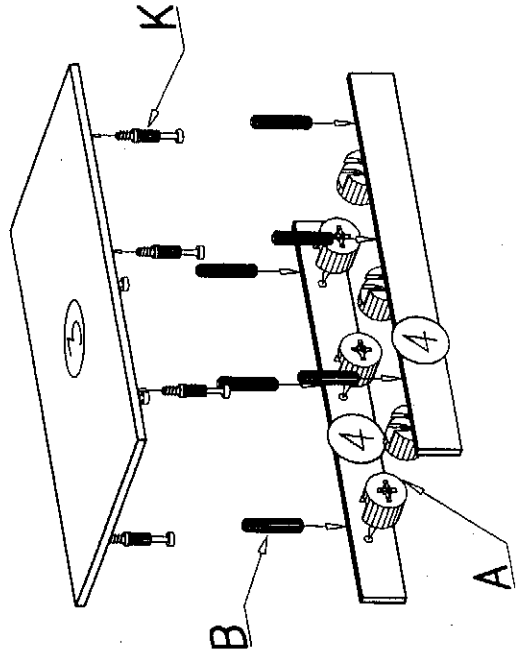

②

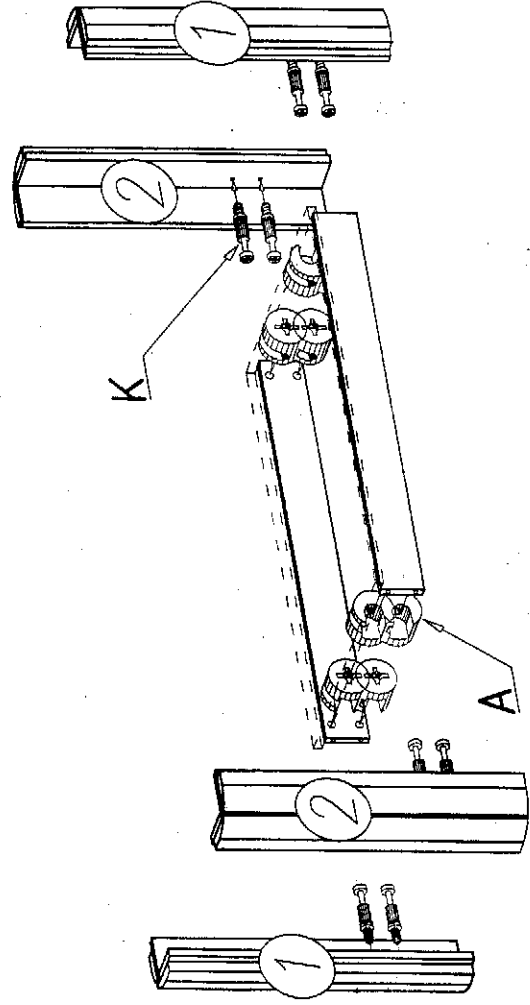

③

