

system DALLAS

D-1

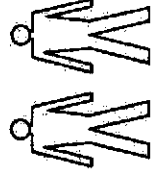

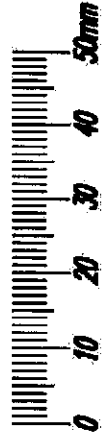



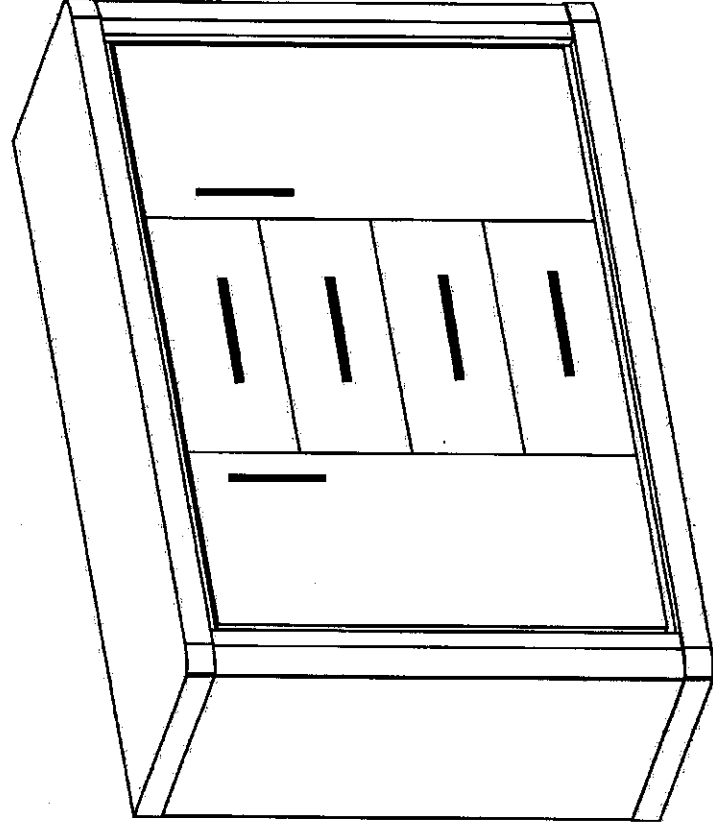
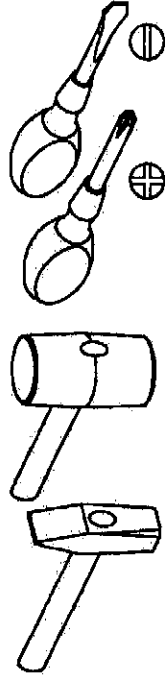







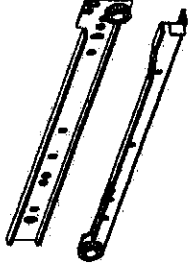

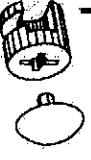
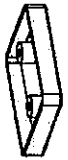

INSTRUKCJA MONTAŻU

Narzędzia potrzebne do montażu



W przypadku reklamacji proszę o podanie numeru pakowacza znajdującego się na kartonie

 R - 12 St. 3 x 30 mm	 P - 8 St.	 M - 16 St. 4 x 25 mm	 H - 1 St.	 F - 16 St.
 T - 4 Kpl.	 N - 12 St. 4 x 30 mm	 U - 6 St.	 G - 8 St. 3,5 x 16 mm	 L - 22 St.
 A - 6 St.	 E - 70 St.	 C - 4 St.	 D - 4 St.	 S - 1 St. KLEJ
 B - 32 St.	 K - 22 St.	 Z - 1 St.	 J - 16 St. 5 x 13 mm	

III

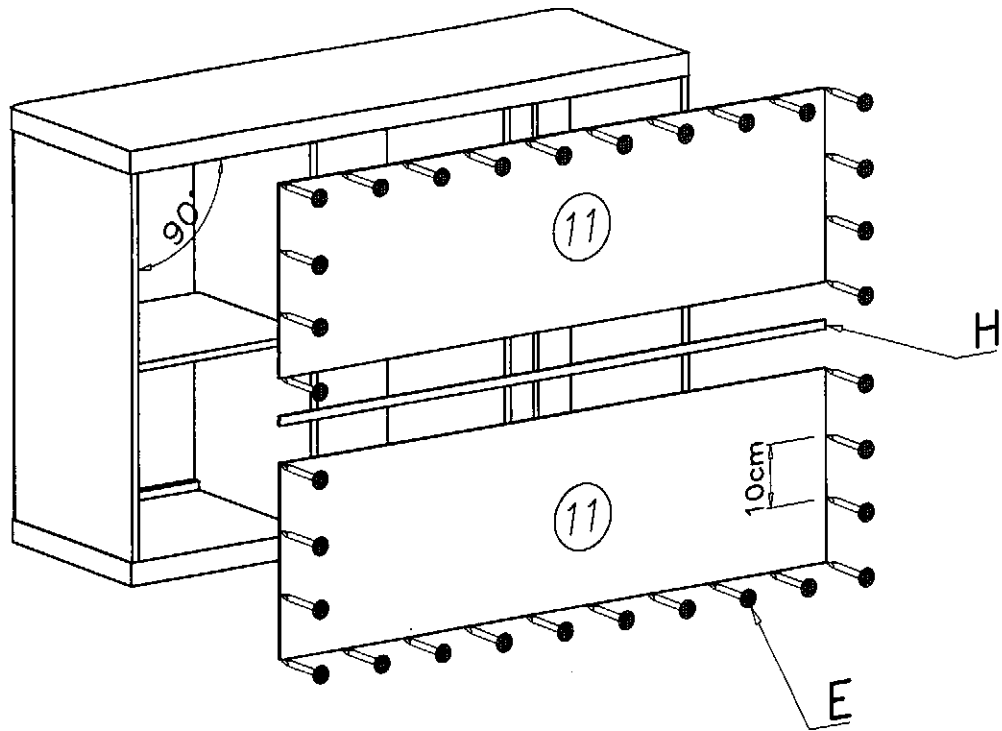

IV

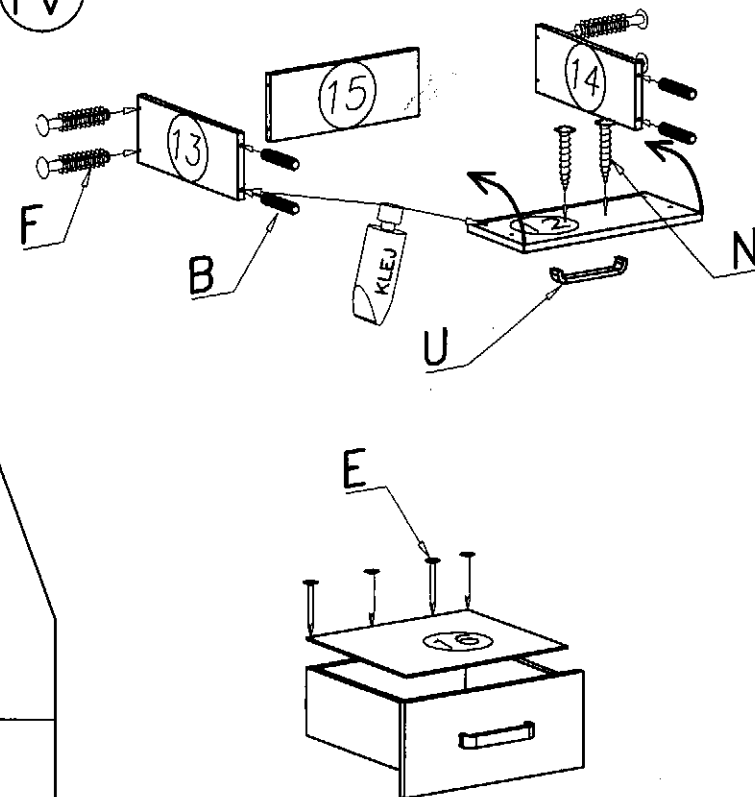

V

